



ADSL, VDSL2 & G.Fast

bintec Dm741-I

Copyright© Version 11.05 bintec elmeg

Legal Notice

Warranty

This publication is subject to change.

bintec offers no warranty whatsoever for information contained in this manual.

bintec is not liable for any direct, indirect, collateral, consequential or any other damage connected to the delivery, supply or use of this manual.

Table of Contents

Chapter 1	ADSL, VDSL2 & G.Fast Technologies.	1
1.1	ADSL	1
1.1.1	Definition	1
1.1.2	Operating frequencies	1
1.1.3	Asymmetry.	1
1.1.4	Modem and splitters	1
1.1.5	Modulation.	2
1.1.6	Range.	3
1.1.7	DSLAM	4
1.1.8	ATM over ADSL	4
1.1.9	Standards	5
1.2	VDSL2	5
1.2.1	Definition	5
1.3	G.Fast	6
1.3.1	Definition	6
Chapter 2	ADSL, VDSL2 & G.Fast Configuration.	7
2.1	Accessing interface configuration	7
2.2	Interface configuration commands	7
2.2.1	? (HELP)	8
2.2.2	[NO] ADVANCED*	8
2.2.3	[NO] AUTO-REBOOT-DELAY*	8
2.2.4	[NO] BER-TEST*	8
2.2.5	[NO] BITS-PER-TONE-LIMIT*	8
2.2.6	[NO] EOC-VENDOR-INFO*	9
2.2.7	[NO] FALLBACK*	9
2.2.8	[NO] FAST-CHANNEL-ADDRESS*	9
2.2.9	[NO] INTERLEAVED-CHANNEL-ADDRESS*	9
2.2.10	LIST	9
2.2.11	[NO] LOG-BUFFER*	10
2.2.12	[NO] OPEN-MODE	10
2.2.13	[NO] PROVIDER*	12
2.2.14	[NO] RX-GAIN-OFFSET*	12
2.2.15	[NO] SHUTDOWN	12
2.2.16	[NO] TARGET-NOISE-MARGIN-OFFSET*	12
2.2.17	[NO] TRELLIS-CODING*	13
2.2.18	[NO] TX-GAIN-OFFSET*	13
2.2.19	EXIT	13
2.3	Commands summary	14
Chapter 3	ADSL, VDSL2 & G.Fast Monitoring	15
3.1	Accessing interface monitoring	15
3.2	Interface monitoring commands	15

3.2.1	? (HELP)	15
3.2.2	CHANNEL	15
3.2.3	CLEAR	17
3.2.4	CLOSE	18
3.2.5	LOG-FILE*	18
3.2.6	OPEN	21
3.2.7	SIGNAL	21
3.2.8	STATUS	23
3.2.9	HISTORIC	24
3.2.10	VENDOR-INFO	24
3.2.11	TEST	25
3.2.12	WHIP	25
3.2.13	EXIT	25

Chapter 1 ADSL, VDSL2 & G.Fast Technologies

1.1 ADSL

1.1.1 Definition

ADSL stands for **A**symmetric **D**igital **S**ubscriber **L**ine.

ADSL is a model from the xDSL family (HDSL, SDSL, etc.).

This is a technology based on a normal copper pair telephone line, which is converted into a high-speed digital line that offers broadband services.

ADSL is a modern technology that simultaneously transmits voice and data over a conventional copper line. Three independent channels are established for this:

- Two high-speed channels (one for data reception and the other to transmit data).
- A third channel for normal voice communications (basic telephone service).

Transmission throughput in User # Network and Network # User directions are different (asymmetric), and can achieve speeds of up to 25 Mbits/s in the network-user direction and 3 MKbit/s in the user-network direction.

This explains why ADSL is able to coexist on the same subscriber loop as the telephone service. This is not possible with a conventional modem as it operates in voice band – which is the same frequency band that telephones use. With ADSL, it's possible to simultaneously receive and maintain a telephone call and transfer data without affecting either service in any way.

1.1.2 Operating frequencies

ADSL technology uses frequency ranges not used in telephony (> 3,400 Hz) or in ISDN basic accesses (> 80 kHz). It operates above these frequencies and up to, approximately, 2.2 MHz (depending on the ADSL standard used).

1.1.3 Asymmetry

ADSL is an asymmetric technology, which means transmission characteristics are not the same for both directions. Reception speed for data is greater than for transmission. As a result, this technology is ideal to access information services and surf the Internet. The user generally receives more information from the Internet than he/she sends, reads more emails than writes, and watches more videos than produces.

1.1.4 Modem and splitters

To complete an ADSL circuit, place a pair of ADSL modems, one at each end of the twisted pair telephone line. One is at the user's residence (connected to a PC or a set-top box device) and the rest (be it one or a group of modems) are located in the local switchboard the user depends on.

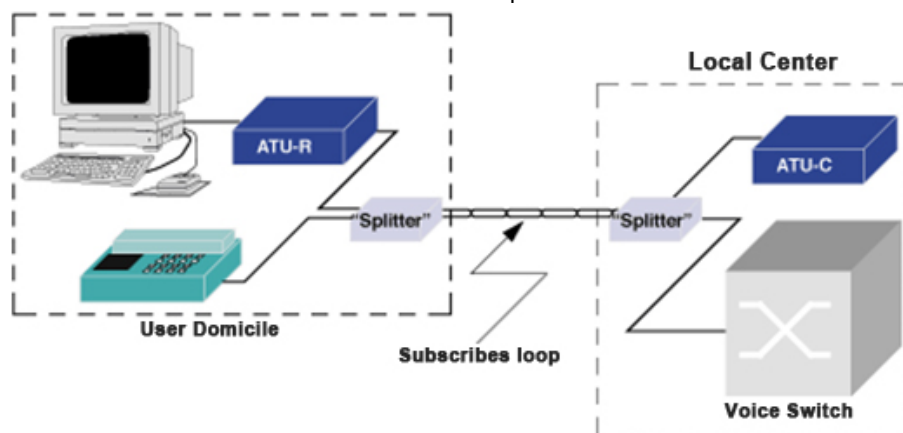

Since this is a modulation where different throughputs are transmitted in User -> Network and Network -> User directions, the ADSL modem at the user end (ATU-R or ADSL Terminal Unit-Remote) is different to the one at the other end of the loop (local central, ATU-C or ADSL Terminal Unit-Central).

The following figure shows a device, known as a splitter, has been placed in front of each modem.

This is simply a set of two filters: one high pass and one low pass. Their task is to separate or combine the high (ADSL) and low (Voice) frequency signals depending on the direction of the transmission (upstream or downstream).

This protects the telephone service signal (central telephone or switch) from interferences in the voiceband produced by the ADSL modems (ATUs) while simultaneously protecting the latter from the telephone service signals.

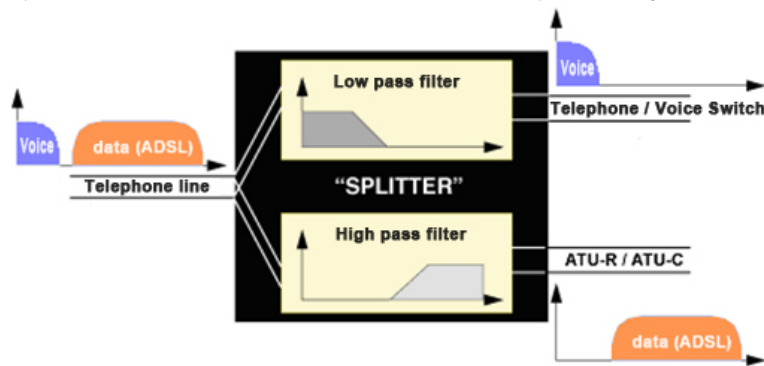

1.1.5 Modulation

The basic implementation uses multiple carriers (multitones) instead of ordinary voiceband modems. Each carrier (known as a subcarrier) is modulated in Quadrature and Amplitude (QAM modulation) by one part of the total flow of data to be transmitted. Subcarriers are separated by 4,3125 KHz. The bandwidth occupied by each modulated subcarrier is 4 KHz.

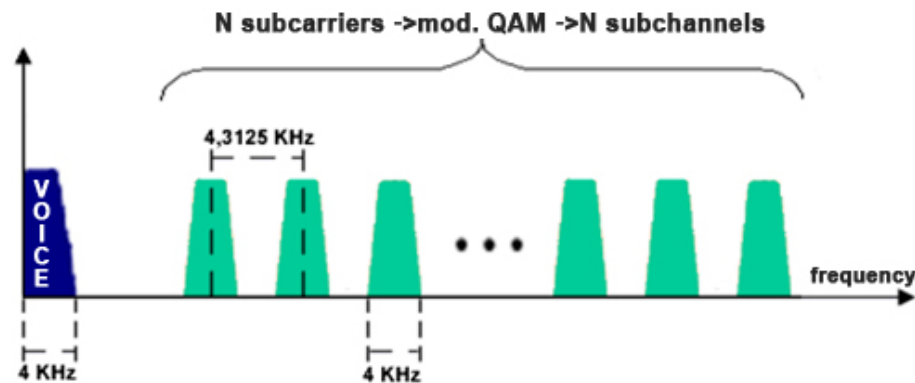

Data flow distribution between subcarriers is executed depending on the estimated Signal/Noise ratio in the band assigned to each. The higher the ratio, the higher the throughput that can be transmitted by each subcarrier (the system adapts to the channel response). The figure shows the bits/channel ratio. Said estimation of Signal/Noise ratio is carried out at the beginning (when the link between the ATU-R and ATU-C is established) through a sequence of predefined training. The modulation technique is the same for both ATU-R and ATU-C (the difference being that ATU-C has up to 512 available subcarriers).

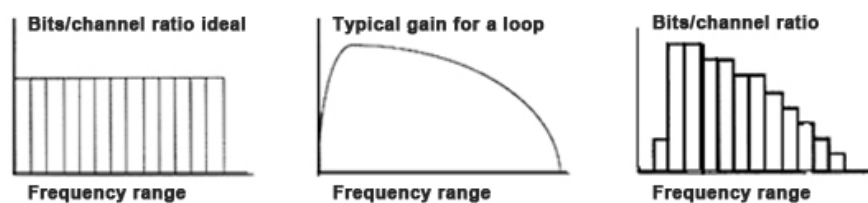

Regardless of the modulation technique used, the ANSI T1.413 standard specifies that ADSL must use Frequency Division Multiplexing (FDM) or Echo Cancellation to achieve full-duplex communication. Both technologies reserve the lowest subchannels for analog voice.

The ANSI T1.413 standard has adopted DMT (Discrete Multitone) as the modulation technique in ADSL. DMT shows better immunity to noise, superior flexibility in transmission speed and greater facility to adapt to the line characteristics than other methods. All this translates into reliability over long distance lines.

Frequency Division Multiplexing divides the range of frequencies into two bands, one upstream and one downstream, which simplifies the design of the modems but reduces the transmission capacity downstream. This is due to the fact that, whilst the same number of subcarriers are available, those with lower frequencies (i.e. those for which the copper pair attenuation is lower) are not.

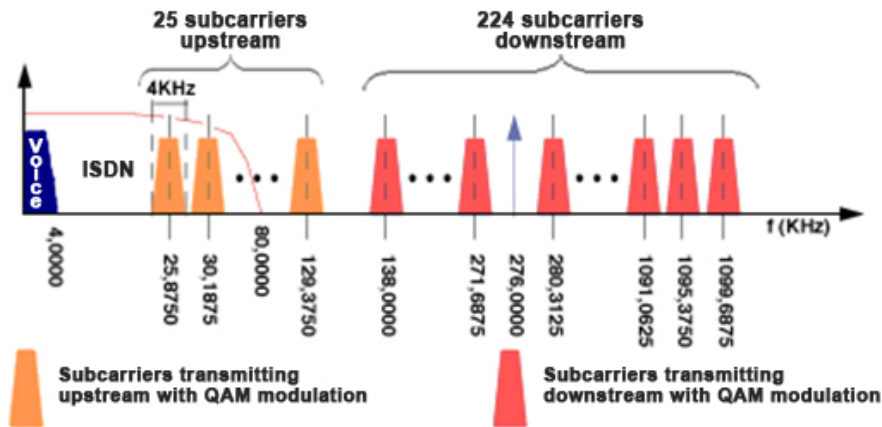

Echo Cancellation eliminates the possibility of a signal in one direction being interpreted as a signal produced by a person in the opposite direction and, consequently, returned to the source as an echo.

Therefore, by separating the signals that correspond to both transmission directions, you get better throughput (even if this means greater complexity in modem design).

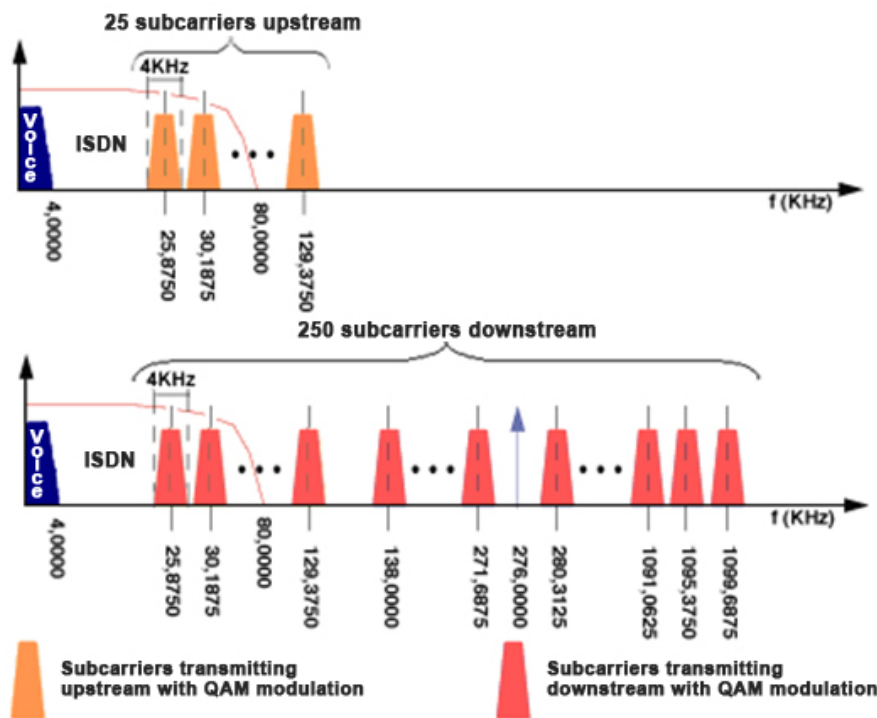

1.1.6 Range

Attenuation on the line increases with frequency and the length of the cable, and decreases when the cable diameter increases. This is why maximum throughput for ADSL modems vary according to loop length and characteristics.

Transmission speeds depend on the length and diameter of the cable. The following factors also have an impact:

- Presence of bridge taps.
- Conservation state of the loop.
- Noise coupling.
- Cross-talk introduced by other services (ISDN, xDSL).

The transmission capacity diminishes when the length of the loop increases.

On decreasing the loop diameter, the maximum reach also decreases.

The presence of external noise provokes a reduction in the Signal/Noise ratio used by each of the subcarriers. This decrease translates (as we have already seen when discussing modulation) into a reduction of the data throughput that modulates each subcarrier and that, in turn, implies a reduction in the total throughput that can be transmitted through the link between the ATU-R and the ATU-C.

1.1.7 DSLAM

ADSL needs a pair of modems for each user: one at the user's residence (ATU-R) and the other (ATU-C) at the local central office where the user's loop is received. This makes this access technology harder to deploy at the central offices. To resolve this problem, the Digital Subscriber Line Access Multiplexer (DSLAM) was developed. It is a rack that groups a large number of cards, each one consisting of various ATU-C modems, to perform the following functions:

- Concentrate several user central modems in the same rack.
- Concentrate (Multiplex/demultiplex) traffic coming from the ADSL links and channel it towards a WAN network.
- Carry out functions at the link layer (ATM protocol over ADSL) between the user modem and the central modem.

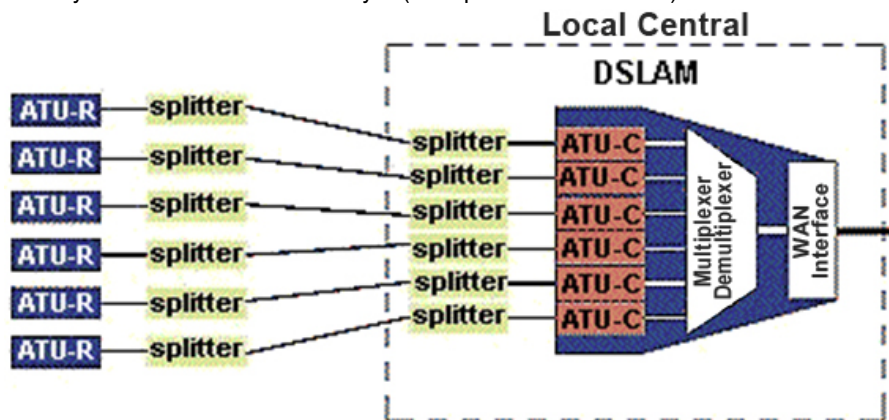

1.1.8 ATM over ADSL

A link layer protocol is required between the ATU-R and the ATU-C.

Communication networks use the ATM protocol (Asynchronous Transfer Mode) to switch in broadband. ATM transmission can be carried out over a large number of physical mediums, including optical fiber and copper lines. The most adequate solution in the latter case is the use of ATM cells to transmit information over the ADSL link.



- The possibility of defining multiple connections over an ADSL link (for different services) is advantageous.
- A link layer protocol is required with Quality of Service mechanisms.

Not all information sources have the same transportation requirements. For example, whereas voice traffic requires a minimum delay, data traffic is not so demanding. Control procedures exist in ATM to guarantee the quality required for the different types of information transferred is met. ATM connections between source and destination are already configured when established to guarantee the contracted quality level. This allows greater efficiency, as each application prompts the network only when necessary and for the quality and service needed (thus optimizing resources).

By using ATM, information (regardless of source) is fragmented into information packets (cells) of a consistent size that are independently transported. As a result, devices and transmission circuits can transport cells originating from different sources.

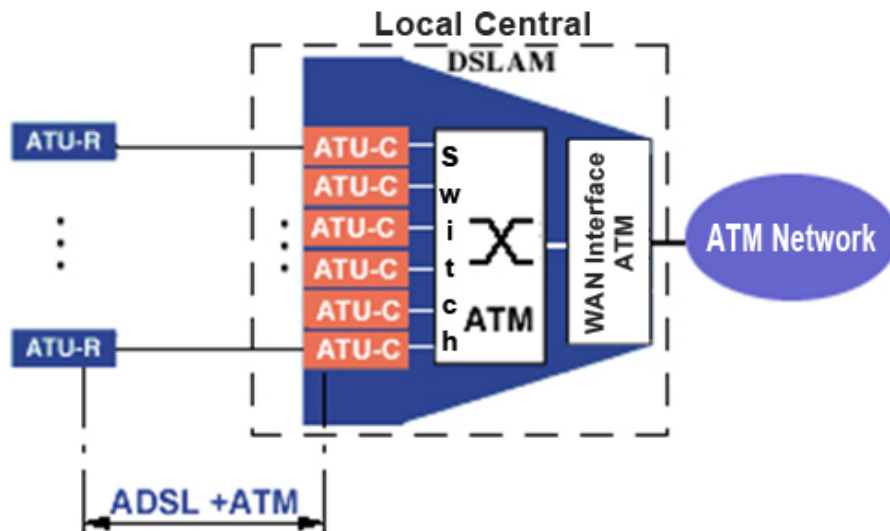

By keeping in mind these advantages, the solution taken to offer services is the transport of ATM cells over an ADSL link (between the ATU-R and ATU-C in DSLAM).

1.1.9 Standards

As with any technology, ADSL requires standards. The latter guarantee products based on this technology are consistent in performance, regardless of the manufacturer, and operate with other devices in the same category.

- The American National Standards Institute (ANSI) in the subcommittee T1.143 issue 1 (1995) and T1.413 issue 2 (1998) defines the standard for the ADSL physical layer. The European Telecommunication Standards Institute (ETSI) has contributed, including an attachment with the European requirements and the TS 101 388 v.1.1.1 with the initial solution for ADSL over ISDN that complies with ANSI.
- Likewise, the International Telecommunications Union (ITU) has issued the following recommendations: G.992.1 (defining ADSL over POTS and ADSL over ISDN), G.992.2 (G. Lite), G.992.3 (ASDL2 or G.DMT.Bis), G.992.4 (ADSL2 splitterless or G.Lite.Bis), G.992.5 (ADSL2+ or G.DMT.Bis Plus), G.994.1, G.995.1, G.996.1 and G.997.1.
- The ADSL Forum is an organization that promotes ADSL technology, developing the necessary protocols, interfaces and architectures. The ADSL Forum works in collaboration with the rest of applicable standards.
- The ATM Forum and the Digital Audio-Visual Council (DAVIC) have recognized ADSL as a physical layer transmission protocol for an unshielded twisted pair.

1.2 VDSL2

1.2.1 Definition

VDSL2 stands for **V**ery high bit rate **D**igital **S**ubscriber **L**ine version 2, which is defined in the ITU G.993.2 and G.993.5 standards.

VDSL2 has evolved from the ADSL/ADSL2/ADSL2+ technologies and the main differences are as follows:

- Upstream and downstream channel multiplicity.

In ADSL there is an upstream channel (US) and a downstream one (DS): VDSL2 provides several alternate upstream and downstream channels by increasing the maximum frequency. This gives rise to different profiles: profile 8 when the maximum frequency is 8.5 MHz, profile 12 (12MHz), profile 17 (17MHz) and profile 30 (30MHz).

US and DS channel alternation allows a bidirectional service definition (not just asymmetric) similar to the one offered by ADSL:



- Supports up to 200 Mbps, symmetric (profile 30a).
- Supports Vectoring (technology that reduces the effect of near-end and/or far-end crosstalk when multiple lines in the same bundle are active).
- It only uses FDM mode, EC mode isn't defined (echo cancellation or carrier overlapping).
- Allows a new encapsulation to be used: PTM.

In ADSL, ATM-AAL5 encapsulation is used on the whole. Two conditions have prompted this: firstly, ATM has not been imposed as a technology in the carrier networks and the standard is, in fact, Ethernet (which means many of the advantages that ATM provides are lost and therefore unnecessary); secondly, the increase in bandwidth provided by VDSL2 makes encapsulation efficiency a parameter to take into consideration. ATM-AAL5 has an efficiency of about 88 %, which means a loss of 12 % of the bandwidth (i.e. 360 Kbps for a 3 Mbps connection). This is acceptable as there are few additional services that can be offered in 360 Kbps. However, a loss of 6 Mbps in a 50 Mbps connection is obviously unacceptable.

The combination of these two facts has given rise to a new encapsulation, Packet Transfer Mode, which increases bandwidth efficiency to 98 % by transporting Ethernet frames.

1.3 G.Fast

1.3.1 Definition

G.Fast, also known as the ITU G.9701 standard, is a digital subscriber line (DSL) technology for gigabit broadband access.

Its main characteristics are:

- Two main profiles: 106 (frequency up to 106MHz) and 212 (frequency up to 212MHz)
- Data rate up to 1Gbps over a 70-meter distance
- Symmetric data rate services support
- Use of PTM as an encapsulation protocol (like VDSL2)

Chapter 2 ADSL, VDSL2 & G.Fast Configuration

2.1 Accessing interface configuration

To access an ADSL/VDSL2/G.Fast interface configuration menu, first access the ATM interface the ADSL/VD-SL2/G.Fast interface is linked to through the **network <ATM interface>** (general config menu). Afterwards, access the physical layer by running **phy**.

```
Config>network atm1/0
-- ATM interface configuration --
atm1/0 config>phy
----- ADSL Config -----
atm1/0:adsl0 config>
```

Some commands are common to all device interfaces. These commands are described in manual bintec Dm772-I Common Configuration Interfaces.

Devices that support VDSL2 and G.Fast have evolved from devices supporting ADSL. These can operate in ADSL, VDSL2 and G.Fast with ATM and PTM encapsulation. Out of the six resulting methods, only three are used:

- ADSL – ATM
- VDSL2 - PTM
- G.Fast - PTM

In order to minimize the impact of G.Fast-PTM and VDSL2-PTM support in the configuration and monitoring of our devices:

- In a device with an ADSL interface, there is an ATM interface (atmx/y) with a submenu (phy) providing access to the ADSL.
- In a device with an ADSL/VDSL2 or ADSL/VDSL2/G.Fast interface there is:

An ATM interface (atmx/y) with a submenu (phy) that provides access to the ADSL/VDSL2/G.Fast (physical layer).

An Ethernet interface (ethernetx/y) that represents the data interface when the connection is established in PTM mode, associated to the same connector as the ATM interface.

Therefore, everything related to xDSL technology is contained in the ATM interface phy submenu, while everything related to the data interface is:

- In the ATM interface and subinterfaces, where negotiation encapsulation is ATM (ADSL); i.e. this is only UP when the xDSL line is opened in ATM mode.
- In the associated Ethernet interface associated where negotiated encapsulation is PTM (VDSL2/G.Fast): i.e. this is only UP when the line is opened in PTM mode.



Note

A ptmx/y interface is not defined, as would be expected, in a similar way to the atm/x/y, because only Ethernet is transported over PTM. A VDSL2-PTM connection is, therefore, more similar to an Ethernet interface (where, instead of using a class 5 twisted pair and protocol 802.3, a telephone subscriber loop and PTM are used).

2.2 Interface configuration commands

All ADSL interface configuration commands are numbered and described in this section.

The ADSL configuration is seldom modified, meaning the parameters usually keep their default values.



Note

A poor configuration can prevent the interface from working or cause some errors.

Command	Function
? (HELP)	Lists the available commands or their options.
ADVANCED*	Configures the advanced parameters.
AUTO-REBOOT-DELAY*	Delay when reboot is mandatory (ATM/PTM change).
BER-TEST*	Enables the bit error rate test.
BITS-PER-TONE-LIMIT*	Sets the bits per tone limit.
EOC-VENDOR-INFO*	Configures the info to send through the EOC channel.
FALLBACK*	Configures the alternative open modes.
FAST-CHANNEL-ADDRESS*	Sets the level two UTOPIA address for the fast channel.
INTERLEAVED-CHANNEL-ADDRESS*	Sets the UTOPIA address for the interleaved channel.
LIST	Displays the interface configuration.
LOG-BUFFER*	Enables error register file capture.
NO	Sets the default value.
OPEN-MODE	Configures the open mode (standard).
PROVIDER*	Configures the provider of the DSL line.
RX-GAIN-OFFSET*	Sets the reception gain offset.
SHUTDOWN	Sets the interface administrative status.
TARGET-NOISE-MARGIN-OFFSET*	Sets the additional noise margin.
TRELLIS-CODING*	Enables Trellis coding.
TX-GAIN-OFFSET*	Sets transmit gain offset.
EXIT	Returns to the previous menu.

* These commands are only available depending on the hardware.

2.2.1 ? (HELP)

Displays a list of the available commands and their options.

2.2.2 [NO] ADVANCED*

Configures advanced parameters for the different chipsets.

This command can only be used by Teldat's technical personnel (to temporarily resolve specific problems).

2.2.3 [NO] AUTO-REBOOT-DELAY*

Some devices need a reboot to toggle ATM/PTM, and this command configures the last delay.

Command history:

Release	Modification
11.01.07	The auto-reboot-delay command was introduced as of version 11.01.07.

2.2.4 [NO] BER-TEST*

Controls BER test inline activation.

Default is disabled.

2.2.5 [NO] BITS-PER-TONE-LIMIT*

Limits the number of bits per tone.

Valid values range from 2 bits per tone to 15 bits per tone (maximum).

2.2.6 [NO] EOC-VENDOR-INFO*

Configures the information sent through the EOC channel:

```
atm0/0:adsl0 config>eoc-vendor-info ?
  silicon      Info from silicon provider
  system       Info from system details
```

The EOC parameters affected are vendor and serial number:

- Running the **silicon** option. These take the DSL chipset manufacturer's default value.
- Running the **system** option. These take the TLDT or ALU value and the device's serial number.

2.2.7 [NO] FALLBACK*

Configures the alternative open modes when running **open-mode**.

```
atm0/0:adsl0 config>fallback <id> open-mode <mode> annex <annex> delay <seconds>
atm0/0:adsl0 config>fallback recommence delay <seconds>
```

The following configures the modem so that the G.DMT Annex A standard can be used. If 60 seconds lapse before synchronization has been initialized, configure the modem to use G.DMT Annex B. Finally, if 70 more seconds lapse without synchronization being initialized, restart the process.

```
atm0/0:adsl0 config>open-mode g.dmt annex a
atm0/0:adsl0 config>fallback 1 open-mode g.dmt annex b delay 60
atm0/0:adsl0 config>fallback recommence delay 70
```

The following configures the modem so that the G.DMT.BIS-PLUS Annex A (ADSL2+ Annex A) standard can be used. If 30 seconds lapse before synchronization has been initialized, try G.DMT.BIS-PLUS Annex M (ADSL2+ Annex M) for 30 seconds. Finally, try running ANSI T1.413 Annex B for 90 seconds and restart the process.

```
atm0/0:adsl0 config>open-mode g.dmt.bis-plus annex A
atm0/0:adsl0 config>fallback 1 open-mode ansi-t1.413 annex A delay 30
atm0/0:adsl0 config>fallback 2 open-mode g.dmt.bis-plus annex M delay 90
atm0/0:adsl0 config>fallback 3 open-mode ansi-t1.413 annex B delay 30
atm0/0:adsl0 config>fallback recommence delay 90
```

Once you have the appropriate synchronization mode, the device stores this in the non-volatile memory for successive connections.

2.2.8 [NO] FAST-CHANNEL-ADDRESS*

Configures a level two UTOPIA address assigned to the ADSL interface FAST channel.

This is only applied when the ATM controller is configured in level 2 UTOPIA mode.

2.2.9 [NO] INTERLEAVED-CHANNEL-ADDRESS*

Configures a level two UTOPIA address assigned to the ADSL interface INTERLEAVED channel.

This is only applied when the ATM controller is configured in level 2 UTOPIA mode.

2.2.10 LIST

Lists the current ADSL interface configuration.

```
atm2/0:adsl0 config>list

Chipset:                ST/Alcatel DynaMite POTS (PCI with FS50 SAR)

Open mode:              Hardware default
Annex:                  A (POTS) (Hardware defined)

Trellis coding:        Enabled
Inline BER test:        Disabled
Tx Gain Offset:         +0.0 dB
Rx Gain Offset:         +0.0 dB
```

```

Target Noise Margin Offset:      +0.0 dB
Bits per tone limit:            maximum available
Get log buffer:                  Disabled

Administrative status
  PHY interface:                 UP
  FAST channel:                  UP
  INTERLEAVED channel:          UP
atm3/0:adsl0 config>list

Chipset:                         Conexant Titanium Ultra Plus Multi Annex (PCI with PQ2SAR)

Open mode:                       G.DMT.Bis-Plus
Annex:                           M (Extended US POTS)
EOC Vendor info:                 Silicon
Administrative status
  PHY interface:                 UP
  FAST channel:                  UP
  INTERLEAVED channel:          UP

```

2.2.11 [NO] LOG-BUFFER*

Enables file capturing. This command registers the negotiation process when it is not successful, allowing you to determine where the error was produced. As this information is of little interest, we recommend disabling this option. File capturing also slows device performance.

2.2.12 [NO] OPEN-MODE

Configures the connection standard to be used in open mode.

```
atm0/0:adsl0 config>open-mode <mode> annex <annex>
```

ansi-t1.413	The ANSI T1.413 standard is only defined for POTS, however the ETSI 101 388 norm is a variant of the ANSI T1.413 standard for ISDN. Therefore where "ANSI T1.413" is discussed, this refers to the ETSI 101 388 standard. (This criterion is followed to be equivalent to the ITU norms.)
annex A	POTS.
annex B	ISDN.
annex HW	Supported by the hardware (A if the hardware is multi-annex).
g.dmt	ITU G.992.1
annex A	POTS.
annex B	ISDN.
annex B-PT*	ISDN compatible with Portugal Telecom DSLAM PTIN.
annex HW	Supported by the hardware (A if the hardware is multi-annex).
g.dmt.bis*	ITU G.992.3 (ADSL2).
annex A	POTS.
annex B	ISDN.
annex L	POTS Extended Reach.
annex M	POTS Extended Upstream.
annex J	ISDN Pure digital.
annex AM	annex A and annex M.
annex BJ	annex B and annex J.
g.dmt.bis-plus*	ITU G.992.5 (ADSL2+).
annex A	POTS.
annex B	ISDN.
annex M	POTS Extended Upstream.
annex J	ISDN Pure digital.

annex AM	annex A and annex M.
annex BJ	annex B and annex J.
u-r2*	ITU G.992.1 Annex B for German Telecom.
g.lite*	ITU G.992.2 (the recommendation contains annexes, however, their meanings are totally different to the rest of the recommendations).
multimode-ansi-t1.413*	ANSI-T1.413 / G.DMT Multimode.
annex A	
annex B	
annex HW	
multimode-g.dmt*	G.DMT / ANSI T1.413 Multimode.
annex A	
annex B	
annex HW	
multimode g.992.x*	G.992.1/G.992.3/G.992.5 multimode, i.e., ADSL, ADSL2 and ADSL2+.
annex A	
annex B	
annex HW	
line-detection*	Configures the interface to initialize negotiation in any Annex A mode so, once activity has been detected, it launches a sequence of configured fallbacks. (If a DSLAM accepts more than one fallback, the only way to guarantee priority between them is to initialize the sequence when DSLAM is detected).
vdsl2*	ITU G.993.2 (VDSL2) and G.993.5* (Vectoring and super-vectoring).
gfast*	ITU G.9701
multimode-itu-tesa*	Configures the interface to initialize negotiation in any ITU mode supported by Telefónica (Spanish carrier), i.e. ADSL2+ Annex A (G.992.5 A), ADSL2+ Annex M (G.992.5 M) and, if supported, VDSL2+ (G.992.3).
multimode-pots*	Configures the interface to initialize negotiation in ADSL and VDSL2 ITU POTS compatible modes. The specific config will depend on the configured provider.
multimode-isdn*	Configures the interface to initialize negotiation in ADSL and VDSL2 ITU ISDN compatible modes. The specific config will depend on the configured provider.
multimode-adsl-pots*	Configures the interface to initialize negotiation in ADSL ITU POTS compatible modes. The specific config will depend on the configured provider.
multimode-adsl-isdn*	Configures the interface to initialize negotiation in ADSL ITU ISDN compatible modes. The specific config will depend on the configured provider.

* Availability depends on the hardware.



Note

To guarantee compatibility, avoid multimode modes where possible (if DSLAM is also in multimode, results are unpredictable).

Command history:

Release	Modification
11.01.07	The multimode-pots mode, multimode-isdn mode, multimode-adsl-pots mode, multimode-adsl-isdn mode, and modes containing annex AM and annex BJ were introduced as of version 11.01.07.
11.01.10	The gfast mode was introduced as of version 11.01.10.

2.2.13 [NO] PROVIDER*

Configures the DSL line provider to enable specific settings:

```
atm0/0:adsl0 config>provider ?
  default           Default provider
  dtag              Deutsche Telekom provider
  vodafone-germany  Vodafone Germany provider
  ewetel            Ewetel provider
  m-net             M-net provider
```

Command history:

Release	Modification
11.01.05	The provider command was introduced as of version 11.01.05.
11.01.07	The vodafone-germany , ewetel , and m-net providers were introduced as of version 11.01.07.

2.2.14 [NO] RX-GAIN-OFFSET*

Configures reception gain offset so that reception is more or less powerful.

Valid values range between -10 and $+10$ dB, with a resolution of 0.1 dB. The value configured is expressed in tenths of dB, the real range depending on the chipset.

- Alcatel DynaMiTe: from -5 dB to $+3$ dB, with a resolution of 0.5 dB

The value (to be programmed in the chip) is the nearest value within the supported range and resolution.

Default is 0.

2.2.15 [NO] SHUTDOWN

Establishes the ADSL interfaces administrative status, i.e. the physical interface and the interfaces corresponding to the Fast Path and the Interleaved Path respectively.

The administrative status is UP by default.

Syntax:

```
atm0/0 ADSL config>shutdown ?
  fast-channel      Fast channel
  interleaved-channel  Interleaved channel
  phy               Physical interface
```



Note

This is a design decision that only takes into account the PHY interface administrative status when establishing the ADSL connection and not the administrative status of the Fast and Interleaved channels. This configuration possibility is included as transparent support for the ADSL-LINE-MIB standard.

2.2.16 [NO] TARGET-NOISE-MARGIN-OFFSET*

Configures an additional margin to the noise margin value configured at the remote end. The line rate is negotiated during ADSL line aperture, to make sure it complies with the noise margin value in DSLAM. Increase (or decrease) said value through this parameter.

Valid values range between -10 and $+10$ dB, with a resolution of 0.1 dB. The value configured is expressed in tenths of dB, the real range depending on the chipset.

- Alcatel DynaMiTe: from -3 dB to $+3$ dB, with a resolution of 0.5 dB.

The value (to be programmed in the chip) is the nearest value within the supported range and resolution.

Default is 0.

2.2.17 [NO] TRELLIS-CODING*

Controls Trellis coding. This coding can be enabled/disabled for all operating modes (support in the G.Lite mode is optional and depends on the chipset used).

Default is enabled.

2.2.18 [NO] TX-GAIN-OFFSET*

Configures transmission gain offset so that transmission is more or less powerful.

Range is between -10 to $+10$ dB, with a resolution of 0.1 dB. Value configured is expressed in tenths of dB, the real range depending on the chipset.

- Alcatel DynaMiTe: from -10 dB to $+3$ dB, with a resolution of 0.5 dB.
- Analog Devices EAGLE: from -5 dB to $+5$ dB, with a resolution of 0.1 dB.

The value (to be programmed in the chip) is the nearest value within the supported range and resolution.

Default is 0 .

2.2.19 EXIT

Returns to the previous menu.

2.3 Commands summary

```
[no] advanced* alcb-dynamite <1..65535> <0x000..0xff> <0x00..0xff>
adi-eagle <1..65535> <4 chars> <0..65535> <0x00000000..0xffffffff>
cnxt-tup <1..65535> <0..255> <0x0000..0xffff>
softdsl-v2a2p-bcm963xx <1..65535> <0..255> <0x00000000..0xffffffff>

[no] auto-reboot-delay* <0..600>
[no] ber-test*
[no] bits-per-tone-limit* <2..14>
[no] eoc-vendor-info* <silicon | system>
[no] fallback* recommence delay <1..65535>
[no] fallback* <1..65535> open-mode ansi-t1.413 annex <A|B|HW> delay <1..65535>
g.dmt annex <A|B|B-PT|HW>
g.dmt.bis annex <A|B|L|M|J>
g.dmt.bis-plus annex <A|B|L|M|J>
g-lite
u-r2
vdsl2
gfast

[no] fast-channel-address* <0..30>
[no] interleaved-channel-address* <0..30>
[no] log-buffer* <1..254>
[no] open-mode ansi-t1.413 annex <A|B|HW>
g.dmt annex <A|B|B-PT|HW>
g.dmt.bis* annex <A|B|L|M|J|AM|BJ>
g.dmt.bis-plus* annex <A|B|M|J|AM|BJ>
g-lite*
u-r2*
multimode-ansi-t1.413 annex <A|B|HW>
multimode-g.dmt annex <A|B|HW>
multimode-g.992.x* annex <A|B|HW>
vdsl2*
gfast*
multimode-itu-tesa*
multimode-pots*
multimode-isdn*
multimode-adsl-pots*
multimode-adsl-isdn*
line-detection*

[no] provider* <default | dtag | vodafone-germany | ewetel | m-net>
[no] rx-gain-offset* <-100..100>
[no] shutdown <fast-channel | interleaved-channel | phy>
[no] target-noise-margin-offset* <-100..100>
[no] trellis-coding*
[no] tx-gain-offset* <-100..100>
```

Chapter 3 ADSL, VDSL2 & G.Fast Monitoring

3.1 Accessing interface monitoring

To access an ADSL/VDSL2/G.Fast interface monitoring menu, first access the ATM interface to which the ADSL/VDSL2/G.Fast interface is linked through **network <ATM interface>** (general config menu). Afterwards, access the physical layer monitoring via **phy**.

```
+network atm1/0
-- ATM Console --
atm1/0 monitor+phy
----- ADSL Monitor -----
atm1/0:adsl0 monitor+
```

3.2 Interface monitoring commands

All ADSL interface monitoring commands are numbered and described in this section.

Command	Function
? (HELP)	Lists all the available commands or their options.
CHANNEL	Information on the channel (phase/interleaved, latency0/latency1).
CLEAR	Restarts the monitoring counters.
CLOSE	Finalizes any interface activity and stops it.
LOG-FILE*	Dumps the log information (if capture was activated).
OPEN	Reactivates interface activity.
SIGNAL	Returns information on the DSL signal.
STATUS	Information on the chipset status.
HISTORIC	Connections history.
VENDOR-INFO	Inventory information on CPE and CO.
UPDATE-FIRMWARE*	Forces Flash firmware file reading.
TEST*	Test commands.
WHIP*	Specific test command for the Conexant chipsets.
EXIT	Exits the ADSL monitoring menu.

* Commands available depending on the hardware.

3.2.1 ? (HELP)

Displays a list of the available commands and their options.

3.2.2 CHANNEL

Displays useful information on the two DSL logical channels (fast and interleaved).

```
atm0/0 ADSL monitor+CHANNEL ?
FAST
INTERLEAVED
PARAMETERS

atm0/0 ADSL monitor+CHANNEL <FAST | INTERLEAVED>
BER-TEST
CELL-COUNTERS
CODIFICATION
INTERVAL
PERFORMANCE
```

3.2.2.1 CHANNEL PARAMETERS

Displays the instantaneous parameters linked to the indicated channel, as specified by the ADSL-LINE-MIB standard.

```
atm0/0 ADSL monitor+CHANNEL PARAMETERS
```

	Fast channel		Interleaved channel	
	Downstream	Upstream	Downstream	Upstream
Interleave Delay (ms)	--	--	0	0
Current Transmit Rate (bps)	0	0	7616000	992000
CRC Block Length	0	0	16184	2108
INP	0.00	0.00	0.00	0.00

<i>Interleave delay</i>	Delay introduced to execute interleaving (only interleaved path).
<i>Current transmit rate</i>	Available data speed, negotiated with the remote end.
<i>CRC block length</i>	ADSL codification block length CRC is applied to.
<i>INP</i>	Impulse Noise Protection in symbols.

3.2.2.2 CHANNEL <FAST | INTERLEAVED> BER-TEST

Shows the results of test execution when the remote end and the local chipsets are Alcatel DynaMiTe and test execution is enabled. Said test is executed in the available bandwidth (difference between the user's reachable speed and the available speed) by inserting empty cells (defined as "second with error", where at least one error is produced in the cells).

The binary error rate (BER) is proportional to quotient "Accumulated bit errors" / "Seconds with valid BER" provided the "Seconds without valid BER" value is close to 0.

```
atm0/0 ADSL monitor+CHANNEL FAST BER-TEST
```

Accumulated bit errors	0
Seconds with valid BER	188
Seconds without valid BER	0

Message shown when the test is unavailable:

```
atm0/0 ADSL monitor+CHANNEL FAST BER-TEST
```

Not available

3.2.2.3 CHANNEL <FAST | INTERLEAVED> CELL-COUNTERS

Displays the cell counters. Since not all chipsets show the same counters, some values (indicated as zero) may not be available.

```
atm0/0 ADSL monitor+CHANNEL INTERLEAVED CELL-COUNTERS
```

	Downstream	Upstream
Total	17048083	183
Delivered	181	--
Idle	17034952	2219266
Unassigned	0	--
Fifo Overflow	0	--
Short	--	0
Long	--	0

<i>Total</i>	Total number of cells (includes: user, idle, unassigned and erroneous HEC).
<i>Delivered</i>	Cells delivered to the SAR device.
<i>Idle</i>	Idle cells received (downstream) or transmitted (upstream).
<i>Unassigned</i>	Unassigned cells received (cells of this type are never transmitted).
<i>FIFO overflow</i>	Overflow in ADSL chip reception queue.
<i>Short</i>	Cells transmitted from the SAR device to the ADSL chip that the latter has dropped (length smaller than 52 bytes).
<i>Long</i>	Cells transmitted from the SAR device to the ADSL chip that the latter has dropped (length greater than 52 bytes).

3.2.2.4 CHANNEL <FAST | INTERLEAVED> CODIFICATION

Displays detailed information on the codification used in the channel.

```

atm0/0 ADSL monitor+CHANNEL INTERLEAVED CODIFICATION

```

	Downstream	Upstream
	-----	-----
Codeword Size	160	96
Parity bytes	16	16

3.2.2.5 CHANNEL <FAST | INTERLEAVED> PERFORMANCE

Displays information on the long-term behavior of the channel, as defined in the ADSL-LINE-MIB standard.

```

atm0/0 ADSL monitor+CHANNEL INTERLEAVED PERFORMANCE

```

	ATU-C	ATU-R
	-----	-----
Received Blocks	1741836	1741491
Transmitted Blocks	1741905	1741560
Corrected Blocks	10212	138
Uncorrected Blocks	11454	15180
Valid Intervals	1	1
Invalid Intervals	0	0
Current 15 min		
Time Elapsed	566	566
Received Blocks	1741836	1741491
Transmitted Blocks	1741905	1741560
Corrected Blocks	10212	138
Uncorrected Blocks	11454	15180
Current day		
Time Elapsed	566	566
Received Blocks	1741836	1741491
Transmitted Blocks	1741905	1741560
Corrected Blocks	10212	138
Uncorrected Blocks	11454	15180
Previous day		
Monitored seconds	0	0
Received Blocks	0	0
Transmitted Blocks	0	0
Corrected Blocks	0	0
Uncorrected Blocks	0	0

<i>Corrected blocks</i>	Blocks received with errors that can be corrected (they do not affect performance).
<i>Uncorrected blocks</i>	Blocks received with errors impossible to correct (they do affect performance).

3.2.2.6 CHANNEL <FAST | INTERLEAVED> INTERVAL

Displays information on the indicated channel behavior in 15-minute intervals, as defined in the ADSL-LINE-MIB standard. (Synchronization between 15-minute intervals and day is managed through the system clock: the first 15-minute interval may terminate prematurely to synchronize the remaining intervals with the clock and, similarly, with the day).

```

atm0/0 ADSL monitor+CHANNEL INTERLEAVED INTERVAL 1

```

	ATU-C	ATU-R
	-----	-----
Interval number	1	1
Received Blocks	1236825	1236480
Transmitted Blocks	1236963	1236549
Corrected Blocks	0	0
Uncorrected Blocks	0	0
Valid Data	true	true

3.2.3 CLEAR

Deletes the information specified.

3.2.4 CLOSE

Closes the ADSL line and leaves it idle until **open** is run.

3.2.5 LOG-FILE*

If the negotiation process capture is enabled and the interface is based on an Alcatel DynaMiTe chipset, the last failed connection register is displayed.

When said capture is not enabled and the chipset is not DynaMiTe (or capture has not terminated), the following message is displayed:

```

atm0/0 ADSL monitor+LOG-FILE
Not available

atm0/0 ADSL monitor+LOG-FILE

Power on the line is -18.062 dBm
tone detected   = 40
-->SNR (lin)   = 4912.636
Power on the line is -20.907 dBm
tone detected   = 56
-->SNR (lin)   = 2438.482
Power on the line is -20.861 dBm
tone detected   = 64
-->SNR (lin)   = 1904.254
AME: peerModemFound at time : 269
--- Activator --- REPORT MODEMLINECONTROLLER notify : ITU_HS_FOUND
PeerModemDetector::stopTranceiver
_active_detectionMode == ADM_DETECT_ITU
HS : TRELIS_IN_LITE_IMPLEMENTED = #0x0#
==>HsSegPool: getFreeSegment: returned [0] =
==>HsSegPool: getFreeSegment: returned [1] =
** HS DL notify state *** enter : 0
** HS DL notify state *** enter : 1
Start HandshakeSequence
Installing initial TEQ coefficients
new gain: 1800 /100
HandshakeSequence(commmon): new gain = 1855 /100

RxGain before C-TONE
AnalogInterface : Message transfered after filtering 0x0x6200
AnalogInterface : Message transfered after filtering 0x0x5002
AnalogInterface : Message transfered after filtering 0x0x5002
doing power measurement on C-TONES
Power on the line is -18.063 dBm
tone detected   = 40
-->SNR (lin)   = 3042.838
Power on the line is -20.907 dBm
tone detected   = 56
-->SNR (lin)   = 1523.930
Power on the line is -20.861 dBm
tone detected   = 64
-->SNR (lin)   = 1183.771
CTones end of detection : 1,40
doCtonesProcessing, measuredPower = 1048576.000
  RMS line single = 87.633
handshakeSequence(nt): new gain = 2498 /100
handshakeSequence(nt): new gain = 3198 /100
RxGain after C-TONE
AnalogInterface : Message transfered after filtering 0x0x6880
Handshake pilot tone: 40
gain scale factor 1.504
g1, g2 : 491,24857
DPLL (g1 = 491, g2= 24857) : freq error = -9.0323486328125e0 ppm, dp11_loop acc = 0xF686
AnalogInterface : Message transfered after filtering 0x0x4EE2

```

```

Remaining frequency error -7.032
DPLL (g1 = 491, g2= 24857) : freq error = -2.50567626953125e0 ppm, dp11_loop acc = 0xFD5F
[before 4QAM - 2BAM] : Remaining frequency error -2.505
4QAM : x = 8174.000, y = 8201.000
DPLL (g1 = 491, g2= 24857) : freq error = -1.7647705078125e0 ppm, dp11_loop acc = 0xFE26
Remaining frequency error = -1.764
Doing phase rotation
installing demodulation
** HS DL notify state *** enter : 3
sending RTone1
pvoTimeRTone1: 745
enable counter reload
HS BIT-BYTE sync :: GALF detected.
HS BIT-BYTE sync :: GALF detected.

##### HsProtTimer :: WARNING time : 615 > 500 ms #####.
HS :: send flags.
** HS DL notify state *** enter : 4
==>HsSegPool: getFreeSegment: returned [2] =
##### HsProtTimer :: timer not running #####.
==>HsSegPool: releaseSegment: found [2] =
##### HsProtTimer :: timer not running #####.
==>HsSegPool: releaseSegment: found [0] =
==>HsSegPool: getFreeSegment: returned [0] =
==>HsSegPool: getFreeSegment: returned [2] =
==>HsSegPool: getFreeSegment: returned [3] =
==>HsSegPool: releaseSegment: found [0] =
==>HsSegPool: releaseSegment: found [2] =
##### HsProtTimer :: timer not running #####.
==>HsSegPool: releaseSegment: found [1] =
** HS DL notify state *** enter : 5
==>HsSegPool: getFreeSegment: returned [0] =
disable Transmit Soc channel -> send quiet.
disable Receive Soc channel.
==>HsSegPool: releaseSegment: found [2] =
==>HsSegPool: releaseSegment: found [0] =
==>HsSegPool: releaseSegment: found [3] =
==>HsSegPool: releaseSegment: found [0] =
** HS DL notify state *** enter : 6
*** start INITIALIZING ***
+++ TRAINING +++
vendor code: 0x0

version code: 0x0
Installing initial TEQ coefficients
AnalogInterface : Message transfered after filtering 0x0x4EE2
AnalogInterface : Message transfered after filtering 0x0x4EE2
RxGain MID before C-REVERB1
AGC phase : 1 , 'gain'=8.600
WARNING !!! getRxBPFGain function is used only for ADSF and AD SG.....
AnalogInterface : Message transfered after filtering 0x0x2200
Putting analog gain to 8 dB
Putting FFT scale to 5
dyn threshold: -38.063
dyn threshold: -38.063
dyn threshold: -38.063
dyn threshold: -38.063
dyn threshold: -38.063
Power on the line is -20.941 dBm
Pilot detected -->SNR (lin) = 780843.264
C_PILOT detected
TrainingSequence::adaptPilotFeq
pilot = 64
x = 1061.437
y = -3001.437
scale = 3.639
installing DPLL coefficients

```

```

DPLL (g1 = 274, g2= 18575) : freq error = -1.04248046875e0 ppm, dp11_loop acc = 0xFEE8
AnalogInterface : Message transfered after filtering 0x0x4F02
DPLL (g1 = 154, g2= 13931) : freq error = -1.86529541015625e0 ppm, dp11_loop acc = 0xFE0B
DPLL (g1 = 86, g2= 10448) : freq error = -1.86529541015625e0 ppm, dp11_loop acc = 0xFE0B
ToneTriggerModule: enable recording of C_REVERB1
P_Rx      = 1.291286945343017578e9
P_echo    = 3.791599988937377929e4
P_tot     = 1.291324853897094726e9
P_RxBoost = 2.829724502563476562e9
AnalogInterface : Message transfered after filtering 0x0x2100
Putting analog gain to 6 dB
Putting FFT scale to 5
+++ ANALYSIS +++
  Pilot rescale ...
x = 7790.875
y = -7766.125
scale = 1.053
Echo Measurement ...
  DcOffset value : -3.10142564773559570e2
Channel Measurement ...
  DcOffset value : -3.1195068359375e2
First TEQ-FEQ calculation
!! FIRST_MEDLEY_TONE_INTEROP_MASKING 220 : DELTA_SNR_INTEROP_MASKING = 2
P_Rx      = 7.734686374664306640e8
P_echo    = 5.747004508972167968e1
P_tot     = 7.734686374664306640e8
Calculated window move parameter : 112
*** Start EXCHANGE ***
New PILOT has carrier number 84
  RTV value for segue detection : 166
+++ start transmitSequence +++
enable synchronuous schedule swap
Seque symbol detected at sync 87 and symb 71
C_MESSAGES1 received completely
Psd down: -40
Target NM: 6
Downstream option #0 interl : 238
Downstream option #0 fast   : 0
Downstream option #0 RS interl:16
Downstream option #0 2*S    : 2
Downstream option #0 Idepth : 64
Downstream option #1 interl : 170
Downstream option #1 fast   : 0
Downstream option #1 RS interl:14
Downstream option #1 2*S    : 2
Downstream option #1 Idepth : 64
Downstream option #2 interl : 86
Downstream option #2 fast   : 0
Downstream option #2 RS interl:7
Downstream option #2 2*S    : 4
Downstream option #2 Idepth : 32
Downstream option #3 interl : 2
Downstream option #3 fast   : 0
Downstream option #3 RS interl:1
Downstream option #3 2*S    : 32
Downstream option #3 Idepth : 4
-----
MODEM INITIALIZING IN OPERATION MODE  G_DMT POTS  !!!!!
INITIALIZATION SPECIFICATIONS : STANDARD COMPLIANT INITIATIZATION  !!!!!
INITIALIZATION SPECIFICATIONS : MINIMUM OVERHEAD FRAMING  !!!!!
-----
AnalogInterface : Message transfered after filtering 0x0x6F02
build R_MESSAGES1
New PILOT has carrier number 94
force counter reload
TransmitSequence: Counter reload event
Calculate final TEQ

```



```

delta = 103      delta_0 = 111
teq gain = 0
Calculate final window move
TEQ-FEQ : DcOffset value : -2.89826202392578125e3
FSE after TEQ: 4
  RTV value for segue detection : 216
SNR Measurement ...
enable counter reload
  SNR measurement ...
Calculating max capacity ...
SNR medley:

38: 27 27      29      32      34      36      37      39      41      43
48: 44 46      47      48      48      49      50      50      51      51
58: 51 52      52      52      52      52      52      53      53      53
68: 53 53      53      54      53      53      53      53      53      53
78: 54 53      54      54      54      54      54      54      54      54
88: 54 54      54      54      54      54      54      54      54      54
98: 54 54      54      54      54      54      54      54      54      54
108: 54 53     54      54      54      54      54      54      54      53
118: 54 53     53      53      53      53      53      53      53      53
128: 53 53     53      53      53      53      53      52      53      52
138: 52 52     52      52      52      52      52      52      52      52
148: 52 52     52      52      52      51      51      51      51      51
158: 51 51     51      51      51      51      51      51      51      51
168: 51 50     50      50      51      50      50      50      50      50
178: 50 50     50      50      50      50      50      50      50      50
188: 50 49     49      49      49      49      49      49      49      49
198: 49 48     48      48      48      48      48      48      48      48
208: 48 48     48      48      48      48      48      47      47      47
218: 47 47     47      47      47      47      47      46      46      46
228: 46 46     46      46      46      46      46      46      46      46
238: 45 45     45      45      45      45      44      44      44      43
248: 43 42     41      40      39      38      36      35

maxPower = 231.884
  Max capacity Execution time   = 51 ms
  Total_number_of_bits_supported = 2690
  Performance_Margin            = 6.000 dB
uncoded snr: 728  coded snr: 650 averageBi : 12
Coding Gain (in units of 0.5 dB : 7
Build R_MESSAGES_RA
enable counter reload
TransmitSequence: Counter reload event
Segue symbol detected at sync 229 and symb 17
decode C_MESSAGES_RA
CRC error for C_MESSAGES_RA
AnalogInterface : Message transfered after filtering 0x0x7E01
Autonomuous Message : Modem init failure

```

3.2.6 OPEN

Disables the **close** command so that the ADSL modem operates normally.

3.2.7 SIGNAL

Displays miscellaneous information on the physical signal.

```

atm0/0 ADSL monitor+SIGNAL ?
INTERVAL
PARAMETERS
PERFORMANCE

```

3.2.7.1 SIGNAL INTERVAL

Displays information on the indicated signal behavior in 15-minute intervals, as defined in the ADSL-LINE-MIB standard. (Synchronization between 15-minute intervals and day is managed through the system clock: the first 15-minute interval may terminate prematurely to synchronize the remaining intervals with the clock and, similarly, with the day).

```
atm0/0 ADSL monitor+SIGNAL INTERVAL <1..96>
          ATU-C          ATU-R
          -----          -----
Interval number          1          1
Loss of framing          0          0
Loss of signal          21         21
Loss of link            0          --
Loss of power           0          0
Errored Seconds        21         21
Valid Data             false      false
```

3.2.7.2 SIGNAL PARAMETERS

Displays instantaneous parameters related to the signal, including the bits per tone load. The process to obtain this information is long (some 20 seconds). You can abort by pressing any key (in which case, any information on the bits per tone will be invalid).

```
atm0/0 ADSL monitor+SIGNAL PARAMETERS
          ATU-C          ATU-R
          -----          -----
Noise Margin (dB)      +14.0          + 7.0
Attenuation (dB)       29.5          28.0
Output Pwr(dBm)       +19.5          +12.0
Attainable Rate (bps) 10176000         1152000
Status                0001          0001
                   No defect      No defect

Operational mode      G.992.1 Annex A
Bits per tone load:
US Tone  0 --> 0 0 0 0 0 0 0 2 4 5 5 5 6 6 6 7
US Tone 16 --> 0 7 7 6 7 6 6 5 5 5 4 3 2 2 0 0
US Load   --> 111
DS Tone  0 --> 0 0 0 0 0 0 0 0 0 0 0 0 0 0 0 0
DS Tone 16 --> 0 0 0 0 0 0 0 0 0 0 0 0 0 0 0 0
DS Tone 32 --> 0 0 0 0 0 0 0 2 2 2 2 2 2 2 2 2
DS Tone 48 --> 2 2 2 2 2 3 2 2 2 2 2 2 2 2 2 2
DS Tone 64 --> 0 2 2 2 2 2 2 2 2 2 2 2 2 2 2 2
DS Tone 80 --> 2 2 2 2 2 0 0 2 2 2 2 2 2 2 2 2
DS Tone 96 --> 2 2 2 2 2 2 2 2 2 2 2 2 2 2 2 2
DS Tone 112 --> 2 2 2 2 2 2 2 2 2 2 2 2 2 2 2 2
DS Tone 128 --> 2 2 2 2 2 2 2 2 2 2 2 2 2 2 2 2
DS Tone 144 --> 2 2 2 2 2 2 2 2 2 2 2 2 2 2 2 2
DS Tone 160 --> 2 2 2 2 0 2 0 0 0 0 0 0 0 0 2 2 2
DS Tone 176 --> 2 2 2 2 2 2 2 2 2 2 2 2 2 2 2 2
DS Tone 192 --> 2 2 2 2 2 2 2 2 2 2 2 2 2 2 2 2
DS Tone 208 --> 2 2 2 2 2 0 2 2 2 2 2 2 2 2 2 2
DS Tone 224 --> 2 2 2 2 2 2 2 2 2 2 2 2 2 2 3 2
DS Tone 240 --> 2 2 2 2 2 2 2 2 2 2 0 0 0 0 0 0
DS Load   --> 400
```

<i>Noise Margin</i>	Additional noise margin existing with respect to the signal/noise ratio required for a 10^{-7} BER (corresponding to a noise margin of 0).
<i>Attenuation</i>	Attenuation measurement.
<i>Output Power</i>	Output power (this value is not available for the EAGLE chipset).
<i>Attainable rate</i>	Maximum speed under normal conditions: does not indicate available data speed.
<i>Status</i>	Flags indicating the signal status: <ul style="list-style-type: none"> ·No defect ·Loss of framing

	<ul style="list-style-type: none"> ·Loss of signal ·Loss of power ·Loss of signal quality
<i>Operational mode</i>	Operational mode synchronization has been reached through: <ul style="list-style-type: none"> ·G.992.1 Annex A ·G.992.1 Annex B ·G.992.2 Annex A ·G.992.2 Annex B ·ANSI T1.413 · ETSI DTS TM-06006
<i>Bits per tone load</i>	Number of bits assigned to each tone making up DMT modulation.

3.2.7.3 SIGNAL PERFORMANCE

Displays information on the long-term behavior of the signal (defined in the ADSL-LINE-MIB).

```

atm0/0 ADSL monitor+SIGNAL PERFORMANCE
                                     ATU-C      ATU-R
                                     -----      -----
Loss of framing seconds                0          0
Loss of signal seconds                 0          0
Loss of link seconds                   0          --
Loss of power seconds                  0          0
Errored seconds                        7          8
Inits                                  0          --
Valid Intervals                       0          0
Invalid Intervals                     0          0
Current 15 min
  Time Elapsed                        188        188
  Loss of framing                      0          0
  Loss of signal                       0          0      Loss of link          0          --
  Loss of power                        0          0
  Errored Seconds                      7          8
  Inits                                 0          --
Current day
  Time Elapsed                        188        188
  Loss of framing                      0          0
  Loss of signal                       0          0
  Loss of link                         0          --
  Loss of power                        0          0
  Errored Seconds                      7          8
  Inits                                 0          --
Previous day
  Monitored seconds                   0          0
  Loss of framing                      0          0
  Loss of signal                       0          0
  Loss of link                         0          --
  Loss of power                        0          0
  Errored Seconds                     0          0
  Inits                                 0          --
    
```

3.2.8 STATUS

Checks the ADSL modem status and the chipset used (in addition to information that is not as relevant).

```

atm0/0 ADSL monitor+STATUS
Chipset          Analog Devices EAGLE (POTS)
Modem status     DOWN
Machine state    INITIALIZE_TX (INITIALIZATION)

-- ADI Eagle specific info --
Modem Flags ..... 00000000
Modem Flags Last Cause ..... 00000000

atm0/0 ADSL monitor+status
    
```

```

Chipset           Alcatel DynaMiTe (POTS)
Modem status      UP
Machine state     Line opened (SHOWTIME)

Revision:         A
Last cause:       none
Interrupts:       638
Interrupts in reset mode: 0
Spurious interrupts: 0
Semaphore failures: 0
Watchdog value:   14
Watchdog failures: 0
Excluding area 1 blocked: false
Excluding area 2 blocked: false
Excluding area 3 blocked: false

atm0/0:adsl0 monitor+status

Chipset           Lantiq VRX2xx
Modem status      UP
Machine state     ACTIVATED (showtime)
Revision:         A
Last cause:       unknown

Capabilities:     ISDN
Reboot needed:   FALSE
Current PPE mode: PTM
Line detected:    TRUE

```

Command history:

Release	Modification
11.01.07	The Line detected output was introduced as of version 11.01.07.

3.2.9 HISTORIC

Displays historic data related to the interface:

```

atm0/0 ADSL monitor+historic

Id      Start           End           Mode      Vendor      NM US (dB)  NM DS (dB)
-----
1 08/02 13:38:15      DMT         ALCB              +34.5      +31.0

```

3.2.10 VENDOR-INFO

Displays information on the manufacturer of the remote (ATU-C) and local (ATU-R) ADSL interfaces. This information varies depending on the operation mode: ITU or ANSI:

ITU:

```

atm0/0 ADSL monitor+VENDOR-INFO

                ATU-C                ATU-R
                -----                -----
ITU Country code: 0x0f                0x00
ITU Reserved:     0x00                0x00
ITU Vendor code:  ALCB                ANDV
ITU vendor specific: 0x0000            0x0000
ITU standard revision: 0x00            0x00
FW Version:       0x00000000            0x42e2ea52
HW Version:       0x00000000            0x1d3a4900

ATU-C FW version:  unknown
ATU-R FW version:  E.67.2.40 rev 1 GS_API_620
ATU-C HW version:  unknown
ATU-R HW version:  DSP 0x0050 AFE 0x0000 TSM C.14

```

ANSI:

```
ADSL atm0/0 monitor+VENDOR-INFO
                                ATU-C          ATU-R
                                -----          -----
ANSI Vendor ID:                 0x0039          0x0000
ANSI Version Number:            Issue 1.0        Issue 1.0
FW Version:                     0x00000000      0x40e4be17
HW Version:                     0x00000000      0x1d3a4900

ATU-C FW version:               unknown
ATU-R FW version:               E.67.2.40 rev 1 GS_API_620
ATU-C HW version:               unknown
ATU-R HW version:               DSP 0x0050 AFE 0x0000 TSM C.14
```

3.2.11 TEST

Allows tests to be executed. Both operation and interpretation are restricted to Teldat's technical personnel.

3.2.12 WHIP

Command for Teldat's technical personnel only.

3.2.13 EXIT

Returns to the previous menu.

```
atm0/0 ADSL monitor+EXIT
atm0/0 monitor+
```