

Manual bintec R1xxx/R3xxx/R4xxx

Reference

Copyright© Version 5.0, 2009 Funkwerk Enterprise Communications GmbH

Legal Notice

Aim and purpose

This document is part of the user manual for the installation and configuration of funkwerk devices. For the latest information and notes on the current software release, please also read our release notes, particularly if you are updating your software to a higher release version. You will find the latest release notes under www.funkwerk-ec.com .

Liability

This manual has been put together with the greatest possible care. However, the information contained in this manual is not a guarantee of the properties of your product. Funkwerk Enterprise Communications GmbH is only liable within the terms of its conditions of sale and supply and accepts no liability for technical inaccuracies and/or omissions.

The information in this manual can be changed without notice. You will find additional information and also release notes for funkwerk devices under www.funkwerk-ec.com .

Funkwerk devices make WAN connections as a possible function of the system configuration. You must monitor the product in order to avoid unwanted charges. Funkwerk Enterprise Communications GmbH accepts no responsibility for data loss, unwanted connection costs and damage caused by unintended operation of the product.

Trademarks

funkwerk trademarks and the funkwerk logo, bintec trademarks and the bintec logo, artem trademarks and the artem logo, elmeg trademarks and the elmeg logo are registered trademarks of Funkwerk Enterprise Communications GmbH.

Company and product names mentioned are usually trademarks of the companies or manufacturers concerned.

Copyright

All rights reserved. No part of this manual may be reproduced or further processed in any way without the written consent of Funkwerk Enterprise Communications GmbH. The documentation may not be processed and, in particular, translated without the consent of Funkwerk Enterprise Communications GmbH.

You will find information on guidelines and standards in the declarations of conformity under www.funkwerk-ec.com .

How to reach Funkwerk Enterprise Communications GmbH

Funkwerk Enterprise Communications GmbH, Südwestpark 94, D-90449 Nuremberg, Germany,
Phone: +49 180 300 9191 0, Fax: +49 180 300 9193 0

Funkwerk Enterprise Communications France S.A.S., 6/8 Avenue de la Grande Lande, F-33174
Gradignan, France, Phone: +33 5 57 35 63 00, Fax: +33 5 56 89 14 05

Internet: www.funkwerk-ec.com

Table of Contents

Chapter 1	Introduction	1
1.1	Possible Applications	2
1.2	Cleaning.	5
1.3	About this guide	5
Chapter 2	Quick Reference	8
2.1	Introduction	8
2.2	System requirements	8
2.3	Presettings	8
2.4	Installation	9
2.4.1	Connections	10
2.4.2	Setting Up and Connecting.	14
2.5	Configuration of	15
2.5.1	Preparations	15
2.5.2	Setting up an ADSL connection.	21
2.5.3	Setting up a wireless LAN (only bintec R1200w, R1200wu and R3000w)	22
2.6	Support Information	23
Chapter 3	Technical data	24
3.1	bintec R1200	24
3.1.1	Scope of supply	24
3.1.2	General Product Features	24
3.1.3	LEDs	26
3.1.4	Connections	28
3.1.5	Pin Assignments	29
3.2	bintec R1200w	30

3.2.1	Scope of supply	31
3.2.2	General Product Features	31
3.2.3	LEDs	34
3.2.4	Connections	35
3.2.5	Pin Assignments	36
3.3	bintec R1200wu	38
3.3.1	Scope of supply	38
3.3.2	General Product Features	39
3.3.3	LEDs	41
3.3.4	Connections	43
3.3.5	Pin Assignments	44
3.4	bintec R3000	48
3.4.1	Scope of supply	48
3.4.2	General Product Features	49
3.4.3	LEDs	51
3.4.4	Connections	53
3.4.5	Pin Assignments	53
3.5	bintec R3000w	56
3.5.1	Scope of supply	56
3.5.2	General Product Features	57
3.5.3	LEDs	59
3.5.4	Connections	61
3.5.5	Pin Assignments	62
3.6	bintec R3400	65
3.6.1	Scope of supply	65
3.6.2	General Product Features	65
3.6.3	LEDs	68
3.6.4	Connections	69
3.6.5	Pin Assignments	70
3.7	bintec R3800	73
3.7.1	Scope of supply	73

3.7.2	General Product Features	73
3.7.3	LEDs	76
3.7.4	Connections	78
3.7.5	Pin Assignments	78
3.8	bintec R4100	81
3.8.1	Scope of supply	81
3.8.2	General Product Features	82
3.8.3	LEDs	84
3.8.4	Connections	86
3.8.5	Pin Assignments	86
3.9	bintec R4300	89
3.9.1	Scope of supply	89
3.9.2	General Product Features	90
3.9.3	LEDs	92
3.9.4	Connections	94
3.9.5	Pin Assignments	94
Chapter 4	Access and configuration.	98
4.1	Access Options.	98
4.1.1	Access via LAN	98
4.1.2	Access via the Serial Interface	101
4.1.3	Access over ISDN	102
4.2	Logging in	103
4.2.1	User names and passwords in ex works state	103
4.2.2	Logging in for Configuration	104
4.3	Configuration options	105
4.3.1	Funkwerk Configuration Interface	106
4.3.2	SNMP shell	121
4.4	BOOTmonitor	121

Chapter 5	System management	123
5.1	State	123
5.2	Global Settings	126
5.2.1	System	126
5.2.2	Passwords.	128
5.2.3	Date and Time	130
5.2.4	System Licences	134
5.3	Interface Mode / Bridge Groups	137
5.3.1	Interfaces	138
5.4	Administrative Access	140
5.4.1	Access	140
5.4.2	SSH	141
5.4.3	SNMP.	145
5.5	Remote Authentication	146
5.5.1	RADIUS	146
5.5.2	TACACS+	151
5.5.3	Options	154
Chapter 6	Physical interfaces	156
6.1	AUX	156
6.1.1	AUX	156
6.2	Ethernet Ports	159
6.2.1	Port Configuration	159
6.3	ISDN Ports	161
6.3.1	ISDN Configuration	162
6.3.2	MSN Configuration	170
6.4	ADSL Modem	172
6.4.1	ADSL Configuration	172

6.5	SHDSL	175
6.5.1	SHDSL Configuration	175
6.6	Serial ports	179
6.6.1	Serial ports	179
6.7	UMTS / HSDPA	181
6.7.1	UMTS / HSDPA / HSUPA	182
Chapter 7	LAN	184
7.1	IP Configuration	184
7.1.1	Interfaces	184
7.2	VLAN	187
7.2.1	VLANs	189
7.2.2	Port Configuration	190
7.2.3	Administration	191
Chapter 8	Wireless LAN	192
8.1	WLAN1	192
8.1.1	Radio Settings	193
8.1.2	Virtual Service Sets	206
8.1.3	WDS Links.	212
8.1.4	Client Link	215
8.2	Administration	219
8.2.1	Basic settings	220
Chapter 9	Routing	221
9.1	Routes	221
9.1.1	IP routes	221
9.1.2	Options	226
9.2	NAT.	227

9.2.1	NAT Interfaces	228
9.2.2	Portforwarding	229
9.3	RIP	233
9.3.1	RIP Interfaces	234
9.3.2	RIP Filter	236
9.3.3	RIP Options	239
9.4	Load Balancing.	242
9.4.1	Load Balancing Groups	242
9.5	Multicast.	244
9.5.1	Forwarding	246
9.5.2	IGMP	247
9.5.3	Options	250
Chapter 10	WAN.	253
10.1	Internet + Dialup	253
10.1.1	PPPoE	255
10.1.2	PPTP	260
10.1.3	PPPoA	265
10.1.4	ISDN	269
10.1.5	GPRS/UMTS	277
10.1.6	AUX	281
10.1.7	IP Pools	288
10.2	ATM	289
10.2.1	Profiles	289
10.2.2	Service Categories	294
10.2.3	OAM Controlling	297
10.3	Leased line	301
10.3.1	Interfaces	302
10.4	Real Time Jitter Control	310
10.4.1	Controlled interfaces	310

Chapter 11	VPN	313
11.1	IPSec	313
11.1.1	IPSec Peers	313
11.1.2	Phase-1 Profiles	322
11.1.3	Phase-2 Profiles	329
11.1.4	IP Pools	334
11.1.5	Options	335
11.2	L2TP	338
11.2.1	Tunnel Profiles	339
11.2.2	User	342
11.2.3	Options	348
11.3	PPTP	349
11.3.1	PPTP Tunnel	349
11.3.2	Options	356
11.4	GRE	357
11.4.1	GRE Tunnels	357
11.5	Certificates	359
11.5.1	Certificate list	360
11.5.2	CRLs	369
11.5.3	Certificate Servers	370
Chapter 12	Firewall	372
12.1	Policies	373
12.1.1	Filter Rules	374
12.1.2	QoS	377
12.1.3	Options	379
12.2	Interfaces	380
12.2.1	Groups	380

12.3	Addresses	381
12.3.1	Address list	382
12.3.2	Groups	383
12.4	Services	384
12.4.1	Service list	384
12.4.2	Groups	386
Chapter 13	VoIP	388
13.1	Application Level Gateway	388
13.1.1	SIP Proxies	388
13.1.2	SIP Endpoints	390
13.2	Media Gateway	392
13.2.1	Extensions	392
13.2.2	SIP Accounts	396
13.2.3	Call Routing	402
13.2.4	CLID Translation	405
13.2.5	Call Translation	407
13.2.6	Options	410
Chapter 14	Local services	413
14.1	DNS	413
14.1.1	Global Settings	415
14.1.2	Static Hosts	418
14.1.3	Domain Forwarding	419
14.1.4	Cache	421
14.1.5	Statistics	423
14.2	DynDNS Client	424
14.2.1	DynDNS Update	424
14.2.2	DynDNS Provider	426
14.3	DHCP Server	428

14.3.1	DHCP Pool	428
14.3.2	IP/MAC Binding	431
14.3.3	DHCP Relay Setting	433
14.4	Web Filter	434
14.4.1	Global Settings	434
14.4.2	Filter List	436
14.4.3	Black / White list	438
14.4.4	History	440
14.5	CAPI Server	440
14.5.1	User	441
14.5.2	Options	442
14.6	Scheduling.	443
14.6.1	Schedule	443
14.6.2	Options	447
14.7	Surveillance	448
14.7.1	Hosts	449
14.7.2	Interfaces	452
14.7.3	Ping Generator	454
14.8	ISDN Theft Protection	456
14.8.1	Options	456
14.9	Funkwerk Discovery	458
14.9.1	Device discovery	458
14.9.2	Options	462
14.10	UPnP	463
14.10.1	Interfaces	463
14.10.2	Global Settings	464
Chapter 15	Maintenance	466
15.1	Diagnostics	466
15.1.1	Ping Test	466

15.1.2	DNS Test	467
15.1.3	Traceroute Test	468
15.2	Software & Configuration	468
15.2.1	Options	468
15.3	Reboot	472
15.3.1	System Reboot.	473
Chapter 16	External Reporting	474
16.1	Syslog	474
16.1.1	Syslog Servers	474
16.2	IP Accounting	477
16.2.1	Interfaces	477
16.2.2	Options	478
16.3	E-mail Alert	479
16.3.1	E-mail Alert Server	479
16.3.2	E-mail Alert Recipient	481
16.4	SNMP.	483
16.4.1	SNMP Trap Options.	483
16.4.2	SNMP Trap Hosts	484
16.5	Activity Monitor	485
16.5.1	Options	486
Chapter 17	Monitoring.	488
17.1	Internal Log	488
17.1.1	System messages	488
17.2	IPSec	489
17.2.1	IPSec Tunnels	490
17.2.2	IPSec Statistics.	492
17.3	ISDN/Modem	493

17.3.1	Current Calls	493
17.3.2	Call History	495
17.4	Interfaces	495
17.4.1	Statistics	496
17.5	WLAN.	497
17.5.1	WLAN1	497
17.5.2	VSS	499
17.5.3	WDS	502
17.5.4	Client Links	504
	Glossary.	507
	Index	548

Chapter 1 Introduction

The powerful devices **bintec R1xxx/R3xxx/R4xxx** have been specially developed for high-speed Internet access and for VPN connections in SMEs and branch offices.

This chapter describes the features your new **bintec** gateway offers. It provides you with an overview of the ways in which your **bintec** gateway can be used. This chapter also tells you about the structure and content of this user's guide.

Safety precautions

The safety precautions, which are supplied with your device, tell you what you need to take into consideration when using your **bintec** gateway.

Installation

How to connect your device is shown in [Installation](#) on page 9. This chapter also tells you what preliminary tasks are necessary for configuration.

Configuration of

How to get your device running is explained in [Configuration of](#) on page 15. There we show you how to start up your device from a Windows PC and how to install other useful online assistants. At the end of the chapter, you will be in a position to surf the Internet, send or receive e-mails and set up a connection to a partner network to access data at your company head office, for example.

Password

If you are already familiar with configuring **bintec** devices and want to get started right away, all you really need to know is the factory default user name and password.

User Name: *admin*

Password: *funkwerk*



Caution

Remember to change the password immediately when you log in to the device for the first time. All **bintec** devices are supplied with the same password, which means they are not protected against unauthorised access until you change the password. How to change the passwords is described in chapter [Passwords](#) on page 128.

1.1 Possible Applications

Connecting networks

Gateways are used to connect networks and to exchange information between the networks. For example, you can use your device to establish a connection to the network of your Internet Service Provider and use the usual Internet services, such as the World Wide Web (WWW) or e-mail.

Access to head office

By connecting to another partner network, e.g. your company's head office, from your home or branch office, you can conveniently access any information you may need from the head office, even if this is geographically far away. These local networks are connected over an ISDN connection or a DSL connection. The size of your own local network – whether it consists of several computers or just one workstation – is irrelevant.

Your gateway is your link to the outside world

Every device serves as a link between the individual local networks. Within each LAN, the gateway is connected to the network like a normal computer. Its task is to transmit information as necessary from its own network to an external network (e.g. to the network of your Internet Service Provider or your head office) and to find the most suitable routes for transmission. Conversely, it receives information and routes it to its own network.

One gateway for everyone

If you have a local network with several computers, you only need a single gateway to allow all computers in the network access to the Internet or the head office. The lower expenditure on equipment and administration for several computers in the network means substantial savings. If you used ISDN cards or modems, every workplace would have to be equipped separately.

High-speed Internet access

If you configure high-speed Internet access with the **bintec** gateway, all the users in the local network profit from faster Internet access. The bandwidth used permits considerably faster Internet applications than conventional ISDN or modems.

Automatic dialling and disconnection

Once configured, your device decides independently if and how it is to set up a connection to the Internet Service Provider. If you enter an external WWW address in your browser, for example, your gateway determines that the requested address lies outside your own LAN and establishes a connection to your Internet Service Provider and the Internet automatic-

ally. To help you save costs, your gateway disconnects the connection after a predefined time (short hold) if no more information is exchanged.

Simple data access

If suitably configured, your device enables you to conveniently access data at another site, e.g. your head office. While running Windows, for example, you can connect a network drive to a computer at your head office. You then simply click the icon for this link in Windows Explorer and can surf in the directories and data of the remote computer just as if you were using your own hard disk. Your gateway takes care of setting up and clearing the connection.

Security/firewall/DynDNS

Your gateway is provided with integrated firewall mechanisms and therefore provides extensive, low-cost features to meet all the requirements for access security. It protects your network against unauthorised external access. This is achieved with functions such as NAT, encryption, filters, monitoring and a Stateful Inspection Firewall.

The Stateful Inspection Firewall (SIF) offers effective protection against attacks from the Internet through dynamic packet filtering. Firewall handling is made easier through numerous pre-configured services. To be able to find partners in spite of dynamic IP addresses, the devices support the DynDNS function. The implemented function enables you to use the DynDNS service of leading DynDNS providers, and some providers have been preset. The security features of the device also include optional content filtering (there is an extra charge for this, 30-day test version included). Here, all the outgoing Internet enquiries are classified, allowing unwanted content to be reliably filtered out.

Other security features

With the scheduling function of the devices, times can be defined in which users are granted individual rights, such as for Internet access. The VLAN function of the devices allows the allocation of users to virtual subnets and offers additional security.

DMZ

All devices offer the possibility of configuring a "Demilitarised Zone" (DMZ). This is a separate network located between the internal LAN and the Internet. The DMZ is the place for all services that have to make direct contact with the Internet. If a web or mail server in the DMZ is attacked, this has no effect on the security of your internal network.

IP Telephony

The application level gateway allows IP telephones in the LAN to establish a connection with SIP providers without neglecting the security of the WAN connection. To do this, the SIP proxy monitors the signalling process between the IP telephone and SIP provider and makes the necessary NAT and firewall releases dynamically for the duration of the commu-

nication.

Wireless LAN

The wireless interface transfers the data at max. 54 mbps (802.11g) and is compatible with the 11 mbps variant 802.11b in the same frequency range. Encryption via the WLAN interface can take place via WPA and WPA2. Virtual WLAN interfaces can be defined via multi-SSID. This means that different rules of access to the WLAN can be implemented, e.g. to log in internal personnel and external visitors.

IPSec

The devices have a powerful IPSec implementation and have ten active VPN tunnel licences ex works. In addition to encryption via AES or 3DES, the devices offer authentication via certificates or preshared keys. In order to optimise the encrypted traffic flow, it can be compressed using IPComp. The Dead Peer Detection function allows the availability of the tunnel endpoint to be checked and restores it if inactive. NAT Traversal is also supported, as is the connection of RADIUS or TACACS+ for authentication.

Configuration and maintenance

A number of options are available for configuring your gateway. Configuration with the **Funkwerk Configuration Interface** is operating system-independent.

Remote maintenance

The devices can also be configured and maintained remotely. As soon as your device is connected to the ISDN - even in its ex works state - configuration settings can be made from another location (e.g. by the administrator at the head office). This means you can have someone at the head office configure the system.

Models

The **bintec R1xxx/R3xxx/R4xxx** models provide you with flexible IP access routers with an integrated ADSL modem (**R3000** and **R3000w** with annex A and annex B) and a 4-port switch. The support of ADSL2+ allows a high-performance WAN connection and permits download rates of up to 24 mbps. A SIP Proxy controls the transparent communication with SIP providers, so that the device can be used in VoIP scenarios such as Internet telephony.

The devices **bintec R1200w**, **R1200wu** and **R3000w** offer WLAN functionality. The WLAN function allows flexible use in wireless environments.

In addition to a 4-port switch and also a further Ethernet port for the LAN/WAN connection, the devices have an ISDN interface for automatic backup or remote dial-in.

1.2 Cleaning

You can clean your device easily. Use a damp cloth or antistatic cloth. Do not use solvents. Never use a dry cloth; the electrostatic charge could cause electronic faults. Make sure that no moisture can enter the device and cause damage.

1.3 About this guide

This document is valid for **bintec** devices with system software as of software version 7.8.1.

The Reference, which you have in front of you, contains the following chapters:



User's Guide - Reference

Chapter	Description
Quick Reference	This contains instructions for how to set up and start up your device and create a basic configuration.
Technical data	This section contains a description of all the device's technical properties.
Access and configuration	This includes explanations about the different access and configuration methods.
System management	These chapters describe all configuration options of the Funkwerk Configuration Interface . The individual menus are described in the order of navigation. The individual chapters also contain more detailed explanations on the subsystem in question.
Physical interfaces	
LAN	
Wireless LAN	
Routing	
WAN	
VPN	
Firewall	
VoIP	
Local services	

Chapter	Description
Maintenance	
External reporting	
Monitoring	
Glossary	The glossary contains a reference to the most important technical terms used in network technology.
Index	The index lists all the key terms for operating the device and all the configuration options and gives page numbers so they can be found easily.

To help you locate information easily, this user's guide uses the following visual aids:

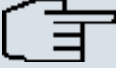
List of visual aids

Icon	Use
	Indicates practical information.
	Indicates general and important points.
	Indicates a warning of risk level Attention (points out possible dangers that may cause damage to property if not observed).
	Indicates a warning of risk level Warning (points out possible dangers that may cause physical injury or even death if not observed).

The following typographical elements are used to help you find and interpret the information in this user's guide:

Typographical elements

Typographical element	Use
•	Indicates lists.
Menu->Submenu File->Open	Indicates menus and sub-menus in the Funkwerk Configuration Interface and Windows interface.
Non-proportional (Courier), e.g. ping	Indicates commands that you must enter as written.

Typographical element	Use
192.168.1.254	
bold, e.g. Windows Start menu	Indicates keys, key combinations and Windows terms.
bold, e.g. <i>biboAdmLoginTable</i>	Indicates fields in the Funkwerk Configuration Interface .
italic, e.g. <i>none</i>	Indicates values that you enter or that can be configured.
Online: blue and italic, e.g. www.funkwerk-ec.com	Indicates hyperlinks.

Chapter 2 Quick Reference

This chapter explains how you set up and start up your device and how you create a basic configuration using the **Funkwerk Configuration Interface**.

2.1 Introduction

You configure your device using the **Funkwerk Configuration Interface**.

The way to obtain the basic configuration is explained below step-by-step. Detailed knowledge of networks is not necessary. A detailed online help system gives you extra support.

The **Companion CD** also supplied includes all the tools that you need for the configuration and management of your device.

The **BRICKware** contains useful applications for managing your device.

2.2 System requirements

Your **bintec** gateway contains extensive features for encrypted data transfer and Internet access for both individual users and companies.

For configuration of the device, your PC must meet the following system requirements:

- Microsoft Windows operating system Windows 2000 or higher
- Internet Explorer 6 or 7, Mozilla Firefox Version 1.2 or higher
- Installed network card (Ethernet)
- CD ROM drive
- Installed TCP/IP protocol
- High colour display (more than 256 colours) for correct representation of the graphics

2.3 Presettings

Preconfigured settings

Your device is shipped with a pre-defined IP configuration:

- **IP Address:** *192.168.0.254*

- **Netmask:** `255.255.255.0`

Use the following access data to configure your device as delivered:

- **User Name:** `admin`
- **Password:** `funkwerk`



Note

All **bintec** devices are delivered with the same username and password. As long as the password remains unchanged, they are therefore not protected against unauthorized use. Make sure you change the passwords to prevent unauthorized access to your device!

Software update

Your device contains the version of the system software available at the time of production. More recent versions may have since been released. You can easily perform an update with the **Funkwerk Configuration Interface** using the **Maintenance-> Software & Configuration** menu.

2.4 Installation

Your gateway offers a number of connection options:

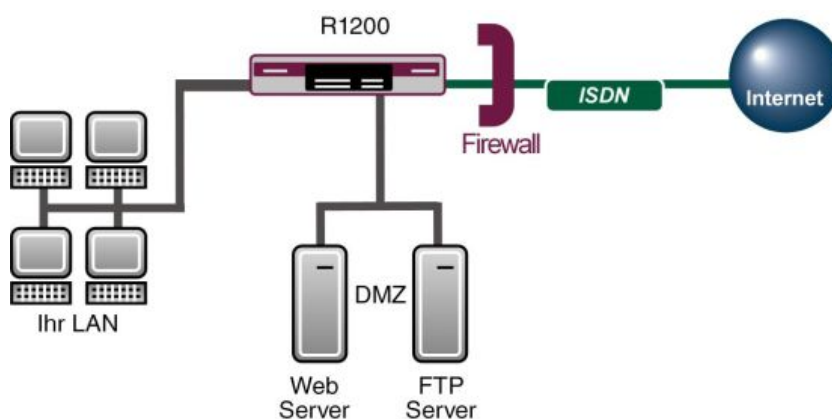

Fig. 2: Basic scenario **bintec R1200**

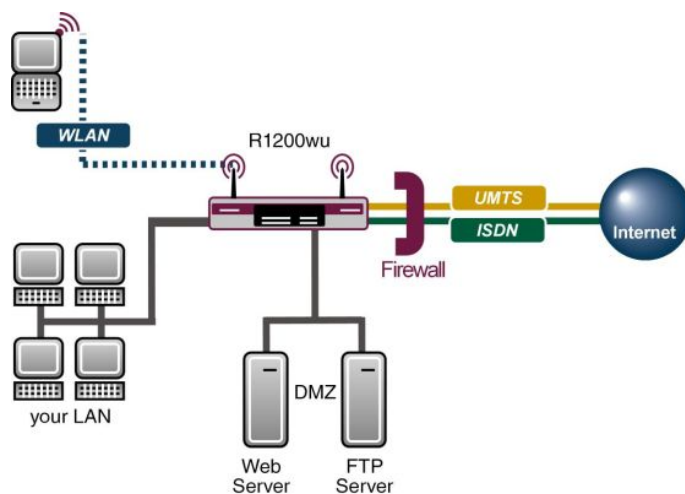

Fig. 3: Basic scenario **bintec R1200wu**



Caution

Please read the safety precautions carefully before installing and starting up your device. These are supplied with the device.

2.4.1 Connections

All connections are located on the back of the device.

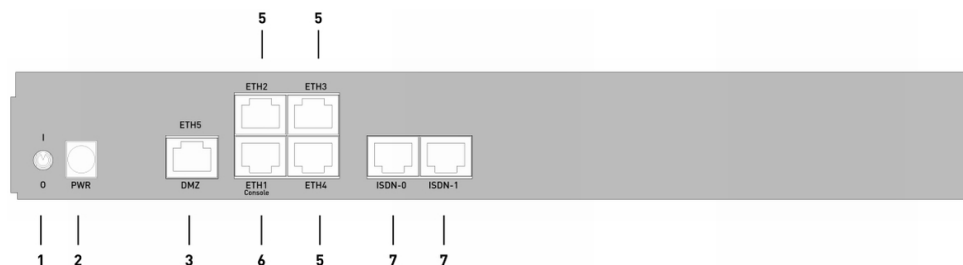

Fig. 4: Back of **bintec R1200**

1	I/O	Mains switch
2	PWR	Socket for plug-in power pack
3	DMZ/ETH5	Ethernet interface
5	ETH2 - ETH4	Ethernet interface
6	ETH1 / Console	Ethernet interface with serial interface function

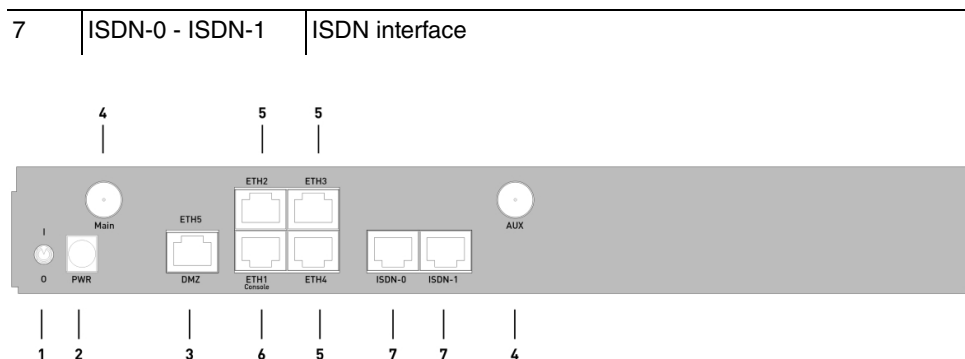

Fig. 5: Back of **bintec R1200w**

1	I/O	Mains switch
2	PWR	Socket for plug-in power pack
3	DMZ/ETH5	Ethernet interface
4	Main and AUX	RSMA connection
5	ETH2 - ETH4	Ethernet interface
6	ETH1 / Console	Ethernet interface with serial interface function
7	ISDN-0 - ISDN-1	ISDN interface

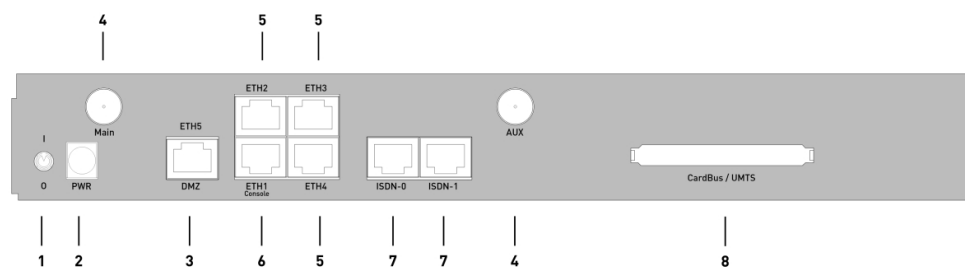
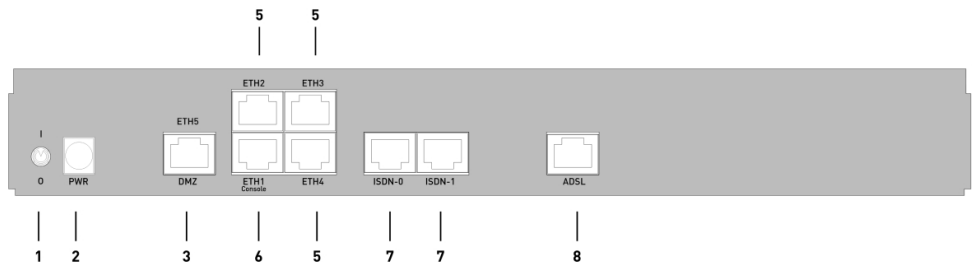
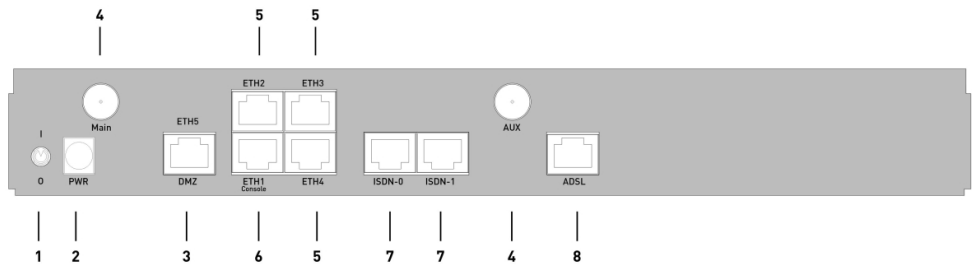

Fig. 6: Back of **bintec R1200wu**

1	I/O	Mains switch
2	PWR	Socket for plug-in power pack
3	DMZ/ETH5	Ethernet interface
4	Main and AUX	RSMA connection
5	ETH2 - ETH4	Ethernet interface
6	ETH1 / Console	Ethernet interface with serial interface function
7	ISDN-0 - ISDN-1	ISDN interface
8	CardBus / UMTS	CardBus slot for UMTS modem

Fig. 7: Back of **bintec R3000**

1	I/O	Mains switch
2	PWR	Socket for plug-in power pack
3	DMZ/ETH5	Ethernet interface
5	ETH2 - ETH4	Ethernet interface
6	ETH1 / Console	Ethernet interface with serial interface function
7	ISDN-0 - ISDN-1	ISDN interface
8	ADSL	ADSL interface

Fig. 8: Back of **bintec R3000w**

1	I/O	Mains switch
2	PWR	Socket for plug-in power pack
3	DMZ/ETH5	Ethernet interface
4	Main and AUX	RSMA connection
5	ETH2 - ETH4	Ethernet interface
6	ETH1 / Console	Ethernet interface with serial interface function
7	ISDN-0 - ISDN-1	ISDN interface
8	ADSL	ADSL interface

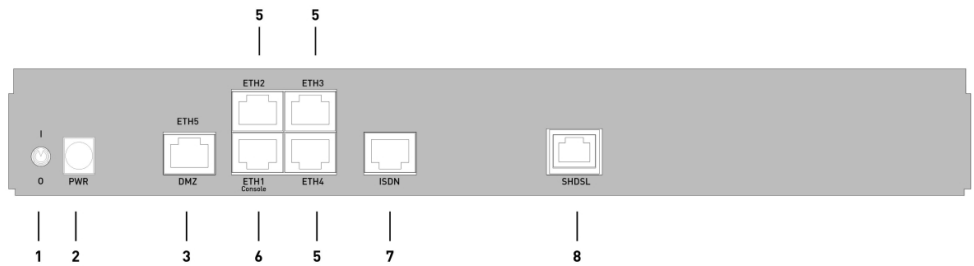

Fig. 9: Back of **bintec R3400 and R3800**

1	I/O	Mains switch
2	PWR	Socket for plug-in power pack
3	DMZ/ETH5	Ethernet interface
5	ETH2 - ETH4	Ethernet interface
6	ETH1 / Console	Ethernet interface with serial interface function
7	ISDN	ISDN interface
8	SHDSL	SHDSL interface

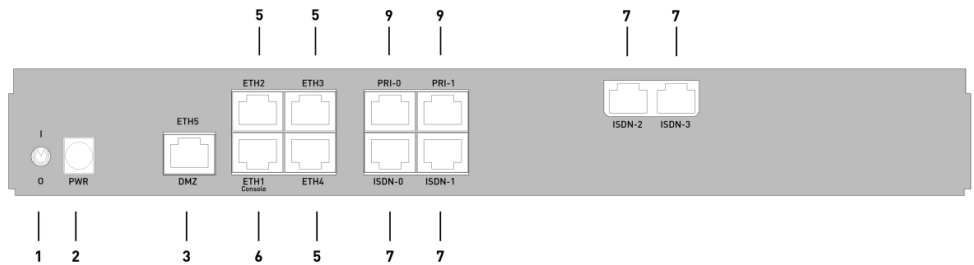

Fig. 10: Back of **bintec R4100**

1	I/O	Mains switch
2	PWR	Socket for plug-in power pack
3	DMZ/ETH5	Ethernet interface
5	ETH2 - ETH4	Ethernet interface
6	ETH1 / Console	Ethernet interface with serial interface function
7	ISDN-0 - ISDN-3	ISDN interface
9	PRI-0 - PRI-1	ISDN-PRI interface

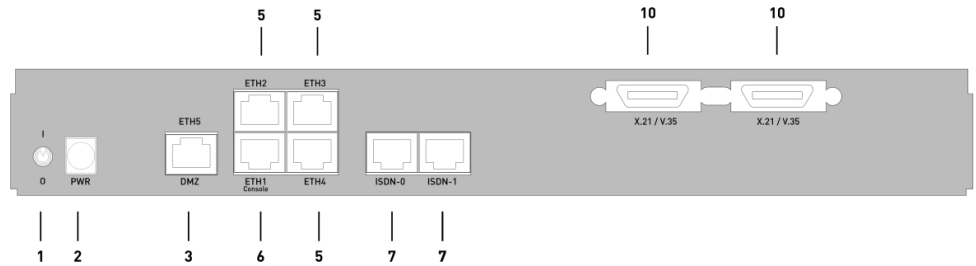

Fig. 11: Back of **bintec R4300**

1	I/O	Mains switch
2	PWR	Socket for plug-in power pack
3	DMZ/ETH5	Ethernet interface
5	ETH2 - ETH4	Ethernet interface
6	ETH1 / Console	Ethernet interface with serial interface function
7	ISDN-0 - ISDN-1	ISDN interface
10	X.21 / V.35	X.21 interface

2.4.2 Setting Up and Connecting

All you need for this are the cables and antennas supplied with the equipment.



Caution

The use of the wrong mains adaptor may damage your device. Only use the mains adaptor supplied with the equipment.

Incorrect cabling of the ISDN and ETH interfaces may also damage your device. Connect only the ETH interface of the device to the LAN interface of the computer/hub or a WAN interface if available and the ISDN interface of the device only to the ISDN connection.

Set up and connect in the following sequence:

- (1) Antennas (only **R1200w**, **R1200wu** and **R3000w**): Screw the external standard antennas provided to their RSMA connections **Main** and **AUX** and align the antennas.
- (2) Place your device on a solid, level base.
- (3) LAN: For the standard configuration of your device via Ethernet, connect the first switch port (**ETH1**) of your device to your LAN using the Ethernet cable supplied. The device automatically detects whether it is connected to a switch or directly to a PC.
- (4) ADSL (only **R3000** and **R3000w**): Connect the ADSL interface (**ADSL**) of your device to the DSL output of the splitter using the DSL cable supplied.

- (5) SHDSL (only **R3400** and **R3800**): Connect the SHDSL interface (**SHDSL**) of your device to the SHDSL connection using the DSL cable supplied.
- (6) Mains connection: Connect the device to a mains socket using the mains adaptor supplied.

Optional connections

- ISDN: Connect the ISDN interface (**ISDN** or **ISDN-x**) of the device to your ISDN socket using the ISDN cable provided.
- Other LANs/WANs: Connect any other terminals in your network to the remaining switch ports **ETH2**, **ETH3** or **ETH4**) of your device using other Ethernet cables.
- Setting up a serial connection: For alternative configuration options, connect the serial interface of your PC with the serial interface of the device. The serial interface can also be assigned to Ethernet socket 1 (**ETH1**). Use the serial cable provided, and if necessary connect your network to another Ethernet socket. However, configuration via the serial interface is not provided by default.
- xDSL modem or DMZ: Connect the WAN interface (**ETH5/DMZ**) of your device to an xDSL modem (not supplied) via another Ethernet cable or with the Ethernet connection on your DMZ.
- PRI (only **R4100**): Connect the ISDN PRI interface (**PRI-0** or **PRI-1**) of the device to your PRI connection.
- X.21 (only **R4300**): Connect an X.21 interface on your device to your **X.21/V.35** or **X.21/V.36** connection using a suitable cable (which you can order as an accessory for your router). Make sure that you use an enabled X.21 interface. The left X.21 interface on the back of the device is enabled by default ex works. The right X.21 interface can also be enabled if licensed.
- UMTS (only **R1200wu**): Insert the UMTS card into the **CardBus / UMTS** slot.

The device is now prepared for configuration using the **Funkwerk Configuration Interface**.

2.5 Configuration of

In this chapter, you will learn how to prepare the configuration, which data you have to collect first, how to perform configuration for a conventional ADSL connection, make adjustments to the PC configurations in the network if necessary and test the connection when the configuration has been completed.

2.5.1 Preparations

To prepare for configuration, you need to...

- have the data for the basic configuration and the Internet connection to hand and also gather the data needed for connecting the required WLAN clients.
- check whether the PC from which you want to perform the configuration meets the necessary requirements.

You can also...

- install the **BRICKware** software, which provides more tools for working with your device. This installation is optional and not essential for the configuration or operation of the device.

2.5.1.1 Gathering data

You can gather the main data for configuration with the **Funkwerk Configuration Interface** quickly, because you do not need any information that requires in-depth knowledge of networks.

If necessary, you can use the sample values.

Before you start the configuration, you should gather the data for the following purposes:

- Basic configuration (if your device is in the ex works state)
- Internet access (optional)
- Wireless LAN (optional, only for **R1200w**, **R1200wu** and **R300w**)
- Connecting to a corporate network (optional)

The following table shows examples of possible values for the necessary access data. You can enter your personal data in the "Your values" column, so that you can refer to these values later when needed.

If you configure a new network, you can use the given example values for IP addresses and netmasks. In cases of doubt, ask your system administrator.

Basic configuration

For a basic configuration of your gateway, you need information that relates to your network environment:

Basic information

Access data	Example value	Your values
IP address of your gateway	192 . 168 . 0 . 254	
Netmask of your gateway	255 . 255 . 255 . 0	

Internet access

If you want to set up Internet access, you need an Internet Service Provider (ISP). You also receive your personal access data from your ISP. The terms used for the required access data may vary from provider to provider, but the type of information you need for dialling in is basically the same.

The following table lists the access data that your device also needs for a DSL connection to the Internet.

Data for Internet access

Access data	Example value	Your values
Provider name	<i>GoInternet</i>	
Protocol	<i>PPP over Ethernet (PPPoE)</i>	
Encapsulation	<i>bridged-no-fcs</i>	
VPI (Virtual Path Identifier)	<i>1</i>	
VCI (Virtual Circuit Identifier)	<i>32</i>	
Your user name	<i>MyName</i>	
Password	<i>TopSecret</i>	

Some Internet Service Providers, such as T-Online, require additional information:

Additional information for T-Online

Access data	Example value	Your values
T-Online number	<i>081512345678</i>	
Joint user account	<i>0001</i>	



Note

To configure T-Online Internet access, in the **Username** field, enter the following succession of numbers without intervening spaces:

User account (12 digits) + T-Online number (usually 12 digits) + co-user number (for the main user, always 0001).

If your T-Online number is less than 12 digits long, a "#" character is required between the T-Online number and the co-user number.

If you use T-DSL, you must add the character string "@t-online.de" at the end of this string of numbers.

Your username could, for example, look like this:

00012345678906112345678#0001@t-online.de

Wireless LAN (only for bintec R1200w, bintec R1200wu and bintec R3000w)

You can operate your device as an access point and therefore connect individual work stations (e.g. laptops, PCs with wireless card or wireless adapter) by wireless connections to your local network via WLAN (Wireless LAN) and let them communicate with each other. The table "Data for the Wireless LAN configuration" shows the information required.

As data can be transmitted over the air in the WLAN, this data can in theory be intercepted and read by any attacker with the appropriate resources. Particular attention must therefore be paid to protecting the wireless connection.

Note the following:

- Follow the safety precautions when configuring your WLAN.
- Please also read the information on WLAN operation published by the Federal Office for Information Security, see <http://www.bsi.bund.de>.

Data for the Wireless LAN configuration

Access data	Example value	Your values
Preshared key for WPA-PSK	without default	
Installation location of your device	<i>Germany</i>	
Channel to be used for WLAN	3	
Network name (SSID) for your WLAN	without default	
Visibility of the network name	<i>not visible</i>	
Security setting	<i>WPA-PSK</i>	

Company network connection

To connect a remote network (e.g. head office), you need to know some data of the remote terminal that will take your call. The remote terminal must also know your details. You have to agree this data between you.

Your device and the device at your head office check before every connection to see if they should take the call from the partner. To protect the network against unauthorised access, the call is accepted only after correct authentication. This authentication is based on a common password and two codes that you and your partner use for the connection.

Data for connection to a company network

Access data	Example value	Your values
Partner name (Key of company head office)	<i>BigBoss</i>	
Dial-in number: (Call number of the company head office's device)	<i>0911987654321</i>	
Local name (Your own code. Your partner (the head office) must enter this name as the partner name on its device.)	<i>LittleIndian</i>	
Password (Common password for this connection, entered on both devices.)	<i>Secret</i>	
Network address(es) of the company head office	<i>10.1.1.0</i>	
Netmask(s) of the company head office	<i>255.255.255.0</i>	

2.5.1.2 Configuring a PC

In order to reach your device via the network and to be able to carry out configuration using the **Express Setup Wizard**, the PC used for the configuration has to satisfy some prerequisites.

- Make sure that the TCP/IP protocol is installed on the PC.
- Assign fixed IP address to your PC.

Checking the TCP/IP protocol

Proceed as follows to check whether you have installed the protocol:

- (1) Click the Windows Start button and then **Settings -> Network and Dial-up Connections** (Windows 2000) or **Settings -> Network Connections** (Windows XP).
- (2) Click on **LAN Connection**.

- (3) Click on **Properties** in the status window.
- (4) Look for the **Internet Protocol (TCP/IP)** entry in the list of network components.

Installing the TCP/IP protocol

If you cannot find the **Internet Protocol (TCP/IP)** entry, install the TCP/IP protocol as follows:

- (1) First click **Properties**, then **Install** in the status window of the **LAN Connection**.
- (2) Select the **Protocol** entry.
- (3) Click **Add**.
- (4) Select **Internet Protocol (TCP/IP)** and click on **OK**.
- (5) Follow the on-screen instructions and restart your PC when you have finished.

Allocating PC IP address

Allocate an IP address to your PC as follows:

- (1) Select **Internet Protocol (TCP/IP)** and click on **Properties**.
- (2) Choose **Use next IP address** and enter a suitable IP address.

Entering the gateway IP address in your PC

Then continue by entering the IP address of the gateway in the configuration of your PC as follows:

- (1) In **Internet Protocol (TCP/IP)** -> **Properties** under **Default gateway**, enter the IP address of your gateway.
- (2) Enter the IP address of your device under **Use next DNS server address**.
- (3) Click on **OK**.
- (4) Close the status window with **OK**.



The computer now has an IP configuration and can access the Internet via the gateway.



Note

You can open the **Funkwerk Configuration Interface** by entering the IP address of your device (192.168.0.254) in a supported browser (Internet Explorer 6 or 7, Mozilla Firefox version 1.2 or later) and entering the pre-configured login information (**User:** *admin*, **Password:** *funkwerk*).

2.5.2 Setting up an ADSL connection

- (1) Go to the **WAN->ATM->Profiles** menu. There is a pre-configured profile that you can adapt to the requirements.
- (2) Choose  to check the settings of the existing profile.
- (3) Simply check that the values for **Virtual Path Identifier (VPI)** and **Virtual Channel Identifier (VCI)** and the **Encapsulation** agree with the data that you received from your ISP. If you did not receive this data, keep the default values. The value *Ethernet over ATM* for **Type** corresponds to a PPPoE connection.
- (4) Change the description of the profile as required, e.g. *GoInternet*.
- (5) Once you have made the changes, confirm them with **OK**.
- (6) Now go to the **Internet+Dialup ->PPPoE** menu and click on **New**.
- (7) Enter a **Description** for the connection, e.g. *GoInternet*.
- (8) For **PPPoE Ethernet Interface**, select *ethoa50-0*.
- (9) As **User Name** and **Password**, enter the access data provided by your ISP.
- (10) If you have an interface with a flatrate, check **Always Active**. This means the ADSL connection is always on and is re-established each time it is terminated.
- (11) Check **Default Route** and **Create NAT Policy**.
- (12) Leave the default settings for all other values.
- (13) Confirm with **OK**. You return to the overview of PPPoE connections.
- (14) If the connection is active, you will see the following symbol in the **Status** column: . However, this does not automatically have to be the case, therefore you should check the connection as described in [Testing the Configuration](#) on page 21.
- (15) Save the configuration by clicking on the **Save Configuration** button above the menu navigation.

2.5.2.1 Testing the Configuration

Once you have completed the configuration of your device, you can test the connection in your LAN and to the Internet.

Carry out the following steps to test your device:



- (1) Test the connection to your device. Click **Run** in the Start menu and enter `ping`, followed by a space and the IP address of your system (e.g. `192.168.0.254`). A window appears with the response "Reply from...".
- (2) Test Internet access by entering www.funkwerk-ec.com in the Internet browser. Funkwerk Enterprise Communications GmbH's Internet site offers you the latest news, updates and documentation.

**Note**

Incorrect configuration of the devices in your LAN may result in unwanted connections and increased charges! Monitor your device and make sure it only sets up connections at the times you want it to. Watch the LEDs on your device (LED for ISDN, ADSL and the Ethernet interface to which you have connected one or more WANs).

2.5.3 Setting up a wireless LAN (only bintec R1200w, R1200wu and R3000w)

Proceed as follows to use your device as an access point in WPA-PSK mode:

- (1) Go to the **Wireless LAN->WLAN1** menu. One VSS is pre-configured: **Funkwerk-ec**.
- (2) Choose  to modify the settings of the existing VSS.
- (3) Set operation mode to *Access Point* and confirm your entry with **OK**.
- (4) You can now configure a wireless network in the **Wireless LAN -> WLAN1 -> Virtual Service Sets -> New VSS** menu.
- (5) Change the **Network Name (SSID)** as desired, e.g. *Client-1*.
- (6) Under **Security Mode**, select *WPA-PSK*.
- (7) Under **Preshared Key**, enter a password of your choice. This must be at least eight characters long, and for security reasons should contain special characters, numbers, and upper and lower case.
- (8) Retain the default values for all the other fields and confirm with **OK**. You return to the VSS overview.
- (9) In the line for the VSS that you have just configured, under **Action**, click on  to activate the VSS and the wireless module.
- (10) Save the configuration by clicking on the **Save Configuration** button above the menu navigation.

2.5.3.1 Configuring the WLAN Adapter under Windows XP

After installing the drivers for your WLAN card, Windows XP set up a new connection in the network environment. Proceed as follows to configure the Wireless LAN connection:

- (1) Right-click on **Start -> Settings ->Network Connections -> Wireless Network Connections**.
- (2) Select **Properties**.
- (3) Go to the **Wireless networks** tab.
- (4) Click **Add**.

Proceed as follows:

- (1) Enter a **Network Name**, e.g. *Client-1*.
- (2) Set **Network Authentication** to *WPA-PSK*.
- (3) Set **Data Encryption** to *TKIP*.
- (4) Under **Network Key** and **Confirm Network Key**, enter the configured preshared key.
- (5) Exit each menu with **OK**.

2.6 Support Information

If you have any questions on your new product or would like more information, you can reach the Support Center of Funkwerk Enterprise Communications GmbH under the following call number or via the E-mail Hotline:

+49 911 9673 1550

hotline@funkwerk-ec.com

For detailed information on our support services, contact www.funkwerk-ec.com.

Chapter 3 Technical data

This chapter summarises all the hardware properties of the **R1200**, **R1200w**, **R1200wu**, **R3000**, **R3000w**, **R3400**, **R3800**, **R4100** and **R4300** devices.

3.1 bintec R1200

3.1.1 Scope of supply

Your device is supplied with the following parts:

- Cable sets/mains unit:
 - Ethernet cable
 - ISDN cable
 - Serial connecting cable
 - Plug-in power pack
- **bintec Companion CD**
- Documentation:
 - **Quick Install Guide** (printed)
 - **User's Guide** (on CD)
 - **Release Notes**, if required
 - **Safety precautions**

3.1.2 General Product Features

The general product features cover performance features and the technical prerequisites for installation and operation of your device.

The features are summarised in the following table:

General Product Features

Property	Value
Product name	bintec R1200

Property	Value
Dimensions and weights:	
Equipment dimensions without cable (B x H x D):	295 mm x 45 mm x 160 mm
Weight	approx. 1260 g
Transport weight (incl. documentation, cables, packaging)	approx. 2,6 kg
Memory	32 MB SDRAM, 8 MB flash ROM
LEDs	18 (1x Power, 1x Status, 5x2 Ethernet, 3x2 Function)
Power consumption of the device	max. 15 Watt, normally 13 Watt
Voltage supply	15 V AC 1.3 A EU PSU
Environmental requirements:	
Storage temperature	-20° to +70 °C
Operating temperature	0° to 40 °C
Relative atmospheric humidity	10 % to 90 % non-condensing in operation, 5 % to 95 % non-condensing when stored
Room classification	Only use in dry rooms.
Available interfaces:	
Ethernet IEEE 802.3 LAN (4-port switch), a port with serial interface	Permanently installed (twisted pair only), 10/100 mbps, auto-sensing, MDIX; supports Baud rates: 1200, 2400, 4800, 9600, 19200, 38400, 57600, 115200 Baud

Property	Value
function	
ISDN-WAN S0 (2)	Permanently installed
DMZ/ETH5	Additional Ethernet switch port
Available sockets:	
Serial interface V.24	RJ45 socket
Ethernet interface	RJ45 socket
ISDN interface	RJ45 socket
Standards & Guidelines	R&TTE Directive 1999/5/EC CE symbol for all EU states
SAFERNET™ Security Technology	Community passwords, PAP, CHAP, MS-CHAP, MS-CHAP v.2, PPTP, PPPoE, PPPoA, Callback, Access Control Lists, CLID, NAT, SIF, MPPE Encryption, PPTP Encryption, VPN with PPTP or IPSec
Software supplied	BRICKware for Windows BRICKtools for Unix
Printed documentation supplied	Quick Reference
Online documentation	User's Guide BRICKware for Windows (Engl.) Software Reference (Engl.)

3.1.3 LEDs

The device LEDs provide information on certain activities and statuses of the device.

They are arranged as follows:

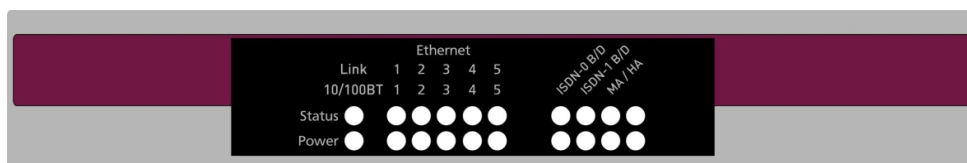

Fig. 12: LEDs on **bintec R1200**

In operating mode, the LEDs display the following status information for your device:

LED status display

LED	State	Information
Power	on	The power supply is connected.
State	Permanently on or off	Error.
	flashing	The device is active.
ETH 1 to 5 Top row	on	The device is connected to the Ethernet.
	flashing	Data traffic via the Ethernet interface.
ETH 1 to 5 Bottom row	on	Data traffic at 100 mbps.
	off	Data traffic at 10 mbps.
ISDN-0 B/D Top row	on	ISDN D-channel is active.
ISDN-0 B/D Bottom row	on	One ISDN B channel is active.
	flashing	Both ISDN B channels are active.
ISDN-1 B/D Top row	on	ISDN D-channel is active.

LED	State	Information
ISDN-1 B/D Bottom row	on	One ISDN B channel is active.
	flashing	Both ISDN B channels are active.
MA / HA Top row	flashing	BRRP packets are received.
MA / HA Bottom row	on	A user is logged in to the system (e.g. over Telnet).

3.1.4 Connections

All the connections are located on the back of the device. **bintec R1200** has a 4-port Ethernet switch including a port with serial interface function, a DMZ/ETH5 interface and two ISDN interfaces.

The connections are arranged as follows:

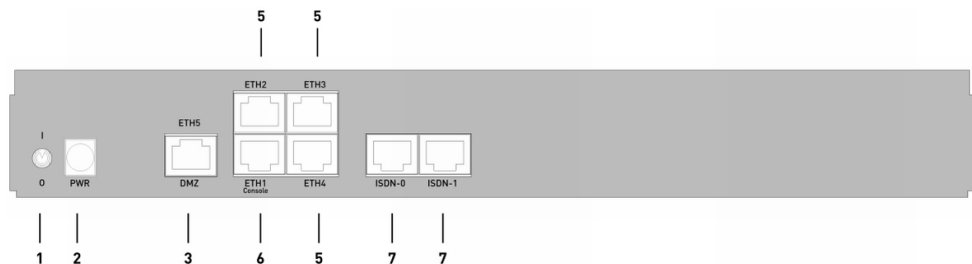

Fig. 13: Back of **bintec R1200**

Back of bintec R1200

1	I/O	Mains switch
2	PWR	Socket for plug-in power pack
3	DMZ/ETH5	Ethernet interface
5	ETH2 - ETH4	Ethernet interface
6	ETH1 / Console	Ethernet interface with serial interface function
7	ISDN-0 - ISDN-1	ISDN interface

3.1.5 Pin Assignments

3.1.5.1 Ethernet interface

The **bintec R1200** has an Ethernet interface with an integrated 4-port switch (ETH1 - ETH4) and a separate Ethernet interface (DMZ/ETH5).

The 4-port switch is used to connect individual PCs or other switches. The *ETH1/Console* interface can also be used as a serial interface. The DMZ/ETH5 interface can be used to connect an optional DSL modem or a DMZ.

The connection is made via an RJ45 socket.

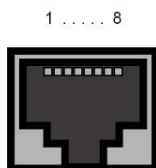

Fig. 14: Ethernet 10/100 Base-T interface (RJ45 socket)

The pin assignment for the Ethernet 10/100 Base-T interface (RJ45 socket) is as follows:

RJ45 socket for Ethernet connection

Pin	Function
1	TD +
2	TD -
3	RD +
4	Not used
5	Not used
6	RD -
7	Not used
8	Not used

The Ethernet 10/100 BASE-T interface does not have an Auto-MDI-X function.

The pin assignment for the Ethernet 10/100 Base-T interface (RJ45 socket) is as follows:

RJ45 socket for Ethernet connection or serial interface (console)

Pin	Function
1	TD + (Ethernet)

Pin	Function
2	TD - (Ethernet)
3	RD + (Ethernet)
4	RX (console)
5	GND (console)
6	RD - (Ethernet)
7	GND (console)
8	TX (console)

The combined serial Ethernet 10/100Base-T interface does not have an Auto-MDI-X function.

3.1.5.2 ISDN So interface

bintec R1200 has two additional ISDN-So interfaces, which can be used for back-up functions, for example.

The connection is made via an RJ45 socket:

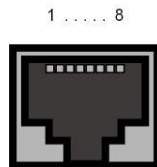

Fig. 15: ISDN So BRI interface (RJ45 socket)

The pin assignment for the ISDN So BRI interface (RJ45 socket) is as follows:

RJ45 socket for ISDN connection

Pin	Function
1	Not used
2	Not used
3	Transmit (+)
4	Receive (+)
5	Receive (-)
6	Transmit (-)
7	Not used
8	Not used

3.2 bintec R1200w

3.2.1 Scope of supply

Your device is supplied with the following parts:

- Cable sets/mains unit:
 - Ethernet cable
 - ISDN cable
 - Serial connecting cable
 - Plug-in power pack
- Antennas:
 - two standard antennas
- **bintec Companion CD**
- Documentation:
 - **Quick Install Guide** (printed)
 - **User's Guide** (on CD)
 - **Release Notes**, if required
 - **Safety precautions**

3.2.2 General Product Features

The general product features cover performance features and the technical prerequisites for installation and operation of your device.

The features are summarised in the following table:

General Product Features

Property	Value
Product name	bintec R1200w
Dimensions and weights:	

Property	Value
Equipment dimensions without cable (B x H x D):	295 mm x 45 mm x 160 mm + 8 mm (antenna socket)
Weight	approx. 1260 g
Transport weight (incl. documentation, cables, packaging)	approx. 2,6 kg
Memory	32 MB SDRAM, 8 MB flash ROM
LEDs	20 (1x Power, 1x Status, 5x2 Ethernet, 4x2 Function)
Power consumption of the device	max. 15 Watt, normally 13 Watt
Voltage supply	15 V AC 1.3 A EU PSU
Environmental requirements:	
Storage temperature	-20° to +70 °C
Operating temperature	0° to 40 °C
Relative atmospheric humidity	10 % to 90 % non-condensing in operation, 5 % to 95 % non-condensing when stored
Room classification	Only use in dry rooms.
Available interfaces:	
Ethernet IEEE 802.3 LAN (4-port switch), a port with serial interface function	Permanently installed (twisted pair only), 10/100 mbps, auto-sensing, MDIX; supports Baud rates: 1200, 2400, 4800, 9600, 19200, 38400, 57600, 115200 Baud
ISDN-WAN S0 (2)	Built-in

Property	Value
DMZ/ETH5	Additional Ethernet switch port
Available sockets:	802.11b, 802.11g and 802.11a with Antenna Diversity
Serial interface V.24	
Ethernet interface	RJ45 socket
ISDN interface	RJ45 socket
Standards & Guidelines	RJ45 socket
SAFERNET™ Security Technology	Community passwords, PAP, CHAP, MS-CHAP, MS-CHAP v.2, PPTP, PPPoE, PPPoA, Callback, Access Control Lists, CLID, NAT, SIF, MPPE Encryption, PPTP Encryption, VPN with PPTP or IPSec
Software supplied	BRICKware for Windows BRICKtools for Unix
Printed documentation supplied	Quick Reference
Online documentation	User's Guide BRICKware for Windows (Engl.) Software Reference (Engl.)



Note

Antenna Diversity

The two antennas do not have equality of access. One is used both to transmit and receive (marked as "main", "primary" or "1"; the antenna next to the power switch), the other is only used to receive. During reception, the AP (Access Point) checks which antenna is receiving a better signal. This is then used for decoding.

3.2.3 LEDs

The device LEDs provide information on certain activities and statuses of the device.

They are arranged as follows:

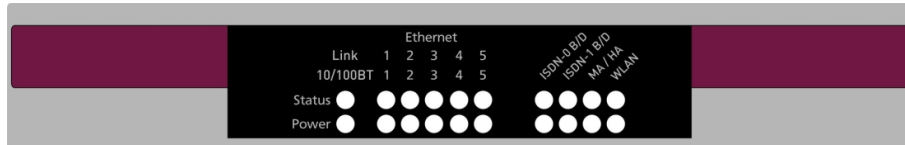

Fig. 16: LEDs on **bintec R1200w**

In operating mode, the LEDs display the following status information for your device:

LED status display

LED	State	Information
Power	on	The power supply is connected.
State	Permanently on or off	Error.
	flashing	The device is active.
ETH 1 to 5 Top row	on	The device is connected to the Ethernet.
	flashing	Data traffic via the Ethernet interface.
ETH 1 to 5 Bottom row	on	Data traffic at 100 mbps.
	off	Data traffic at 10 mbps.
ISDN-0 B/D Top row	on	ISDN D-channel is active.
ISDN-0 B/D Bottom row	on	One ISDN B channel is active.

LED	State	Information
	flashing	Both ISDN B channels are active.
ISDN-1 B/D Top row	on	ISDN D-channel is active.
ISDN-1 B/D Bottom row	on	One ISDN B channel is active.
	flashing	Both ISDN B channels are active.
MA / HA Top row	flashing	BRRP packets are received.
MA / HA Bottom row	on	A user is logged in to the system (e.g. over Telnet).
WLAN Top row	on	The WLAN module is active.
WLAN Bottom row	flashing	Data traffic via the WLAN interface.

3.2.4 Connections

All the connections are located on the back of the device. **bintec R1200w** has a 4-port Ethernet switch including a port with serial interface function, a DMZ/ETH5 interface and two ISDN interfaces.

The connections are arranged as follows:

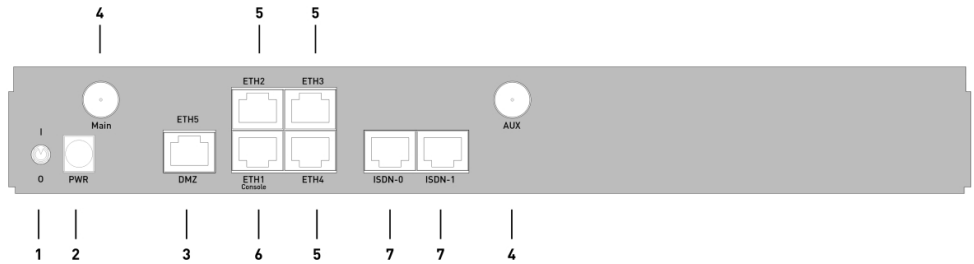

Fig. 17: Back of **bintec R1200w**

Back of bintec R1200w

1	I/O	Mains switch
2	PWR	Socket for plug-in power pack
3	DMZ/ETH5	Ethernet interface
4	Main and AUX	RSMA connection
5	ETH2 - ETH4	Ethernet interface
6	ETH1 / Console	Ethernet interface with serial interface function
7	ISDN-0 - ISDN-1	ISDN interface

3.2.5 Pin Assignments

3.2.5.1 Ethernet interface

The **bintec R1200w** has an Ethernet interface with an integrated 4-port switch (ETH1 - ETH4) and a separate Ethernet interface (DMZ/ETH5).

The 4-port switch is used to connect individual PCs or other switches. The *ETH1/Console* interface can also be used as a serial interface. The DMZ/ETH5 interface can be used to connect an optional DSL modem or a DMZ.

The connection is made via an RJ45 socket.

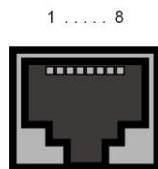

Fig. 18: Ethernet 10/100 Base-T interface (RJ45 socket)

The pin assignment for the Ethernet 10/100 Base-T interface (RJ45 socket) is as follows:

RJ45 socket for Ethernet connection

Pin	Function
1	TD +
2	TD -
3	RD +
4	Not used
5	Not used
6	RD -
7	Not used
8	Not used

The Ethernet 10/100 BASE-T interface does not have an Auto-MDI-X function.

The pin assignment for the Ethernet 10/100 Base-T interface (RJ45 socket) is as follows:

RJ45 socket for Ethernet connection or serial interface (console)

Pin	Function
1	TD + (Ethernet)
2	TD - (Ethernet)
3	RD + (Ethernet)
4	RX (console)
5	GND (console)
6	RD - (Ethernet)
7	GND (console)
8	TX (console)

The combined serial Ethernet 10/100 BASE-T interface does not have an Auto-MDI-X function.

3.2.5.2 ISDN So interface

bintec R1200w has two additional ISDN-So interfaces, which can be used for back-up functions, for example.

The connection is made via an RJ45 socket:

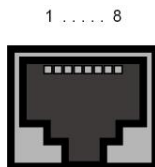

Fig. 19: ISDN So BRI interface (RJ45 socket)

The pin assignment for the ISDN So BRI interface (RJ45 socket) is as follows:

RJ45 socket for ISDN connection

Pin	Function
1	Not used
2	Not used
3	Transmit (+)
4	Receive (+)
5	Receive (-)
6	Transmit (-)
7	Not used
8	Not used

3.3 bintec R1200wu

3.3.1 Scope of supply

Your device is supplied with the following parts:

- Cable sets/mains unit:
 - Ethernet cable
 - ISDN cable
 - Serial connecting cable
 - Plug-in power pack
- Antennas:
 - two standard antennas
- **bintec Companion CD**

- Documentation:
 - **Quick Install Guide** (printed)
 - **User's Guide** (on CD)
 - **Release Notes**, if required
 - **Safety precautions**

3.3.2 General Product Features

The general product features cover performance features and the technical prerequisites for installation and operation of your device.

The features are summarised in the following table:

General Product Features

Property	Value
Product name	bintec R1200wu
Dimensions and weights:	
Equipment dimensions without cable (B x H x D):	295 mm x 45 mm x 160 mm + 8 mm (antenna socket)
Weight	approx. 1260 g
Transport weight (incl. documentation, cables, packaging)	approx. 2,6 kg
Memory	32 MB SDRAM, 8 MB flash ROM
LEDs	20 (1x Power, 1x Status, 5x2 Ethernet, 4x2 Function)
Power consumption of the device	max. 15 Watt, normally 13 Watt
Voltage supply	24 V AC 1 A EU PSU

Property	Value
Environmental requirements:	
Storage temperature	-20° to +70 °C
Operating temperature	0° to 40 °C
Relative atmospheric humidity	10 % to 90 % non-condensing in operation, 5 % to 95 % non-condensing when stored
Room classification	Only use in dry rooms.
Available interfaces:	
Ethernet IEEE 802.3 LAN (4-port switch), a port with serial interface function	Permanently installed (twisted pair only), 10/100 mbps, auto-sensing, MDIX; supports Baud rates: 1200, 2400, 4800, 9600, 19200, 38400, 57600, 115200 Baud
ISDN-WAN S0 (2)	Built-in
DMZ/ETH5	Additional Ethernet switch port
WLAN interface (antennas)	802.11b, 802.11g and 802.11a with Antenna Diversity
CardBus interface (PCMCIA)	Interface for integrating a UMTS modem card
Available sockets:	
Serial Interface	RJ45 socket
Ethernet interface	RJ45 socket
ISDN interface	RJ45 socket
CardBus interface	68-pole PCMCIA socket
SAFERNET™ Security Technology	Community passwords, PAP, CHAP, MS-CHAP, MS-CHAP v.2, PPTP, PPPoE, PPPoA, Callback, Access Control Lists, CLID, NAT, SIF, MPPE Encryption, PPTP Encryption, VPN with PPTP or IPsec
Software supplied	BRICKware for Windows

Property	Value
	BRICKtools for Unix
Printed documentation supplied	Quick Reference
Online documentation	User's Guide BRICKware for Windows (Engl.) Software Reference (Engl.)



Note

Antenna Diversity

The two antennas do not have equality of access. One is used both to transmit and receive (marked as "main", "primary" or "1"; the antenna next to the power switch), the other is only used to receive. During reception, the AP (Access Point) checks which antenna is receiving a better signal. This is then used for decoding.

3.3.3 LEDs

The device LEDs provide information on certain activities and statuses of the device.

They are arranged as follows:

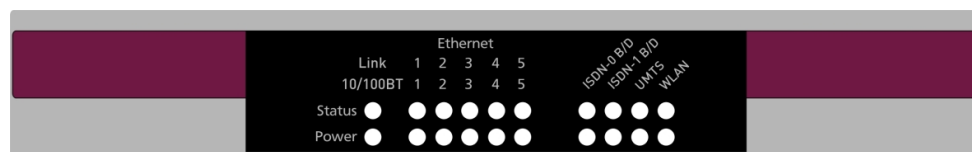

Fig. 20: LEDs on **bintec R1200wu**

In operating mode, the LEDs display the following status information for your device:

LED status display

LED	State	Information
Power	on	The power supply is connected.

LED	State	Information
State	Permanently on or off	Error.
	flashing	The device is active.
ETH 1 to 5 Top row	on	The device is connected to the Ethernet.
	flashing	Data traffic via the Ethernet interface.
ETH 1 to 5 Bottom row	on	Data traffic at 100 mbps.
	off	Data traffic at 10 mbps.
ISDN-0 B/D Top row	on	ISDN D-channel is active.
ISDN-0 B/D Bottom row	on	One ISDN B channel is active.
	flashing	Both ISDN B channels are active.
ISDN-1 B/D Top row	on	ISDN D-channel is active.
ISDN-1 B/D Bottom row	on	One ISDN B channel is active.
	flashing	Both ISDN B channels are active.
UMTS Top row	on	UMTS connection set up.
UMTS Bottom row	flashing	Data traffic over UMTS.

LED	State	Information
WLAN Top row	flashing	Data traffic via the WLAN interface.
WLAN Bottom row	slow flashing	The WLAN module is active.
	on	At least one WLAN client is connected.

3.3.4 Connections

All the connections are located on the back of the device. **bintec R1200wu** has a 4-port Ethernet switch including a port with serial interface function, a DMZ/ETH5 interface and two ISDN interfaces as well as a CardBus slot for a UMTS modem.

The connections are arranged as follows:

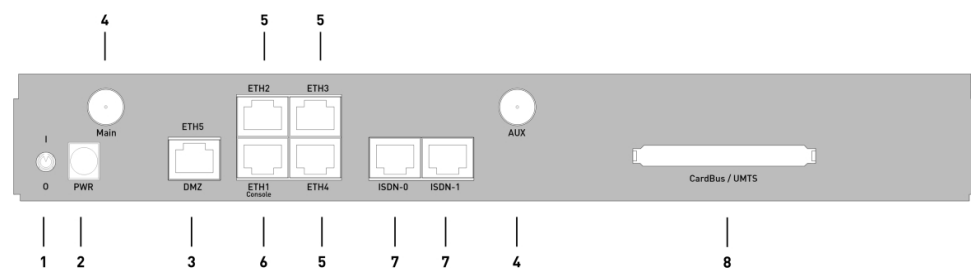

Fig. 21: Back of **bintec R1200wu**

Back of bintec R1200wu

1	I/O	Mains switch
2	PWR	Socket for plug-in power pack
3	DMZ/ETH5	Ethernet interface
4	Main and AUX	RSMA connection
5	ETH2 - ETH4	Ethernet interface
6	ETH1 / Console	Ethernet interface with serial interface function
7	ISDN-0 - ISDN-1	ISDN interface
8	CardBus	CardBus slot for UMTS modem

3.3.5 Pin Assignments

3.3.5.1 Ethernet interface

The **bintec R1200wu** has an Ethernet interface with an integrated 4-port switch (ETH1 - ETH4) and a separate Ethernet interface (DMZ/ETH5).

The 4-port switch is used to connect individual PCs or other switches. The *ETH1/Console* interface can also be used as a serial interface. The DMZ/ETH5 interface can be used to connect an optional DSL modem or a DMZ.

The connection is made via an RJ45 socket.

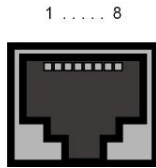

Fig. 22: Ethernet 10/100 Base-T interface (RJ45 socket)

The pin assignment for the Ethernet 10/100 Base-T interface (RJ45 socket) is as follows:

RJ45 socket for Ethernet connection

Pin	Function
1	TD +
2	TD -
3	RD +
4	Not used
5	Not used
6	RD -
7	Not used
8	Not used

The Ethernet 10/100 BASE-T interface does not have an Auto-MDI-X function.

The pin assignment for the Ethernet 10/100 Base-T interface (RJ45 socket) is as follows:

RJ45 socket for Ethernet connection or serial interface (console)

Pin	Function
1	TD + (Ethernet)

Pin	Function
2	TD - (Ethernet)
3	RD + (Ethernet)
4	RX (console)
5	GND (console)
6	RD - (Ethernet)
7	GND (console)
8	TX (console)

The combined serial Ethernet 10/100 BASE-T interface does not have an Auto-MDI-X function.

3.3.5.2 ISDN So interface

bintec R1200wu has two additional ISDN-So interfaces, which can be used for back-up functions, for example.

The connection is made via an RJ45 socket:

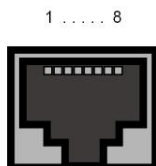

Fig. 23: ISDN So BRI interface (RJ45 socket)

The pin assignment for the ISDN So BRI interface (RJ45 socket) is as follows:

RJ45 socket for ISDN connection

Pin	Function
1	Not used
2	Not used
3	Transmit (+)
4	Receive (+)
5	Receive (-)
6	Transmit (-)
7	Not used
8	Not used

3.3.5.3 CardBus interface (PCMCIA)

The CardBus interface allows a UMTS CardBus modem to be added to the system.

The modem card is inserted in the existing CardBus slot and is integrated automatically by the system. You can insert the card even when the device is running (hot-pluggable).

If the card is not integrated automatically, the system does not support this specific card. Our support staff will be pleased to help if you have any questions.

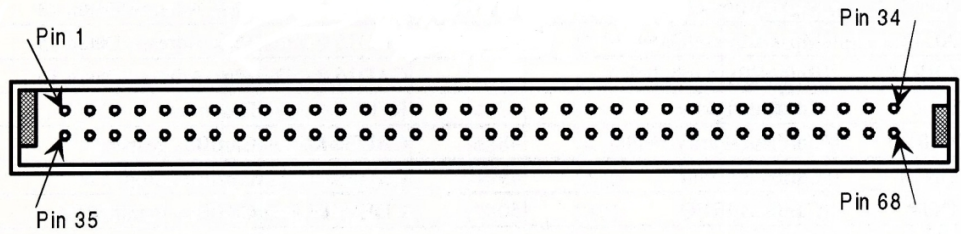

Fig. 24: 68-pin CardBus slot for UMTS modem card

The pin assignment is as follows:

Pin assignment of the CardBus slot

Pin	Function	Description
1	GND	Ground
2	CAD0	Mpx address/data 0
3	CAD1	Mpx address/data 1
4	CAD3	Mpx address/data 3
5	CAD5	Mpx address/data 5
6	CAD7	Mpx address/data 7
7	CCBE0#	Command/Byte possible 0
8	CAD9	Mpx address/data 9
9	CAD11	Mpx address/data 11
10	CAD12	Mpx address/data 12
11	CAD14	Mpx address/data 14
12	CCBE1#	Command/Byte possible 1
13	CPAR	CardBus Parity
14	CPERR#	CardBus Parity error
15	CGNT#	CardBus Grant

Pin	Function	Description
16	CINT#	CardBus IREQ
17	VCC	Card power supply
18	VPP1	Programming voltage 1
19	CCLK	CardBus cycle
20	CIRDY#	CardBus initiator ready
21	CCBE2#	Command/Byte possible 2
22	CAD18	Mpx address/data 18
23	CAD20	Mpx address/data 20
24	CAD21	Mpx address/data 21
25	CAD22	Mpx address/data 22
26	CAD23	Mpx address/data 23
27	CAD24	Mpx address/data 24
28	CAD25	Mpx address/data 25
29	CAD26	Mpx address/data 26
30	CAD27	Mpx address/data 27
31	CAD29	Mpx address/data 29
32	RFU	Reserved
33	CCLKRUN#	Start CardBus cycle
34	GND	Ground
35	GND	Ground
36	CCD1#	Card ID 1
37	CAD2	Mpx address/data 2
38	CAD4	Mpx address/data 4
39	CAD6	Mpx address/data 6
40	RFU	Reserved
41	CAD8	Mpx address/data 8
42	CAD10	Mpx address/data 10
43	CVS1	Voltage ID 1
44	CAD13	Mpx address/data 13
45	CAD15	Mpx address/data 15
46	CAD16	Mpx address/data 16
47	RFU	Reserved

Pin	Function	Description
48	CBLOCK#	CardBus blocked
49	CSTOP#	CardBus stop
50	CDEVSEL#	CardBus device selection
51	VCC	Card power supply
52	VPP2	Programming voltage 2
53	CTRDY#	CardBus destination ready
54	CFRAME#	CardBus Cycle Frame
55	CAD17	Mpx address/data 17
56	CAD19	Mpx address/data 19
57	CVS2	Voltage ID 2
58	CRST#	Reset CardBus
59	CSERR#	CardBus system error
60	CREQ#	CardBus request
61	CCBE3#	Command/Byte possible 3
62	CAUDIO	CardBus audio
63	CSTSCHG	CardBus status change
64	CAD28	Mpx address/data 28
65	CAD30	Mpx address/data 30
66	CAD31	Mpx address/data 31
67	CCD2#	Card ID 2
68	GND	Ground

3.4 bintec R3000

3.4.1 Scope of supply

Your device is supplied with the following parts:

- Cable sets/mains unit:
 - Ethernet cable
 - ISDN cable
 - Serial connecting cable

- 2 DSL cables (for Annex A and for Annex B)
- Plug-in power pack
- **bintec Companion CD**
- Documentation:
 - **Quick Install Guide** (printed)
 - **User's Guide** (on CD)
 - **Release Notes**, if required
 - **Safety precautions**

3.4.2 General Product Features

The general product features cover performance features and the technical prerequisites for installation and operation of your device.

The features are summarised in the following table:

General Product Features

Property	Value
Product name	bintec R3000
Dimensions and weights:	
Equipment dimensions without cable (B x H x D):	295 mm x 45 mm x 160 mm
Weight	approx. 1260 g
Transport weight (incl. documentation, cables, packaging)	approx. 2,6 kg
Memory	32 MB SDRAM, 8 MB flash ROM
LEDs	18 (1x Power, 1x Status, 5x2 Ethernet, 3x2 Function)

Property	Value
Power consumption of the device	max. 15 Watt, normally 13 Watt
Voltage supply	15 V AC 1.3 A EU PSU
Environmental requirements:	
Storage temperature	-20° to +70 °C
Operating temperature	0° to 40 °C
Relative atmospheric humidity	10 % to 90 % non-condensing in operation, 5 % to 95 % non-condensing when stored
Room classification	Only use in dry rooms.
Available interfaces:	
ADSL interface	Internal ADSL modem for Annex A and Annex B.
Ethernet IEEE 802.3 LAN (4-port switch), a port with serial interface function	Permanently installed (twisted pair only), 10/100 mbps, auto-sensing, MDIX; supports Baud rates: 1200, 2400, 4800, 9600, 19200, 38400, 57600, 115200 Baud
ISDN-WAN S0 (2)	Permanently installed
DMZ/ETH5	Additional Ethernet switch port
Available sockets:	
Serial interface V.24	RJ45 socket
Ethernet interface	RJ45 socket
ISDN interface	RJ45 socket
ADSL interface	RJ45 socket
Standards & Guidelines	R&TTE Directive 1999/5/EC CE symbol for all EU states

Property	Value
SAFERNET™ Security Technology	Community passwords, PAP, CHAP, MS-CHAP, MS-CHAP v.2, PPTP, PPPoE, PPPoA, Callback, Access Control Lists, CLID, NAT, SIF, MPPE Encryption, PPTP Encryption, VPN with PPTP or IPSec
Software supplied	BRICKware for Windows BRICKtools for Unix
Printed documentation supplied	Quick Reference
Online documentation	User's Guide BRICKware for Windows (Engl.) Software Reference (Engl.)

3.4.3 LEDs

The device LEDs provide information on certain activities and statuses of the device.

They are arranged as follows:

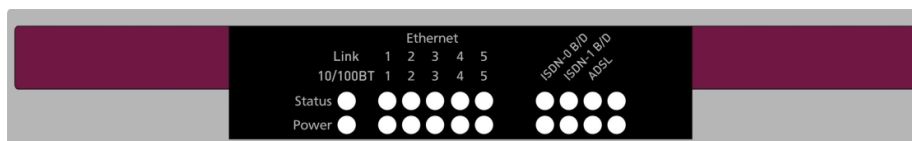

Fig. 25: LEDs on **bintec R3000**

In operating mode, the LEDs display the following status information for your device:

LED status display

LED	State	Information
Power	on	The power supply is connected.
State	Permanently on or off	Error.
	flashing	The device is active.

LED	State	Information
ETH 1 to 5 Top row	on	The device is connected to the Ethernet.
	flashing	Data traffic via the Ethernet interface.
ETH 1 to 5 Bottom row	on	Data traffic at 100 mbps.
	off	Data traffic at 10 mbps.
ISDN-0 B/D Top row	on	ISDN D-channel is active.
ISDN-0 B/D Bottom row	on	One ISDN B channel is active.
	flashing	Both ISDN B channels are active.
ISDN-1 B/D Top row	on	ISDN D-channel is active.
ISDN-1 B/D Bottom row	on	One ISDN B channel is active.
	flashing	Both ISDN B channels are active.
ADSL Top row	flashing	The device synchronises with the DSLAM of the ADSL provider.
	on	The device has successfully synchronised with the DSLAM of the ADSL provider.
ADSL Bottom row	flashing	Data traffic via the ADSL interface.
	synchronous flash-	ADSL Handshake.

LED	State	Information
	ing	
	asynchronous flashing	ADSL system error.

3.4.4 Connections

All the connections are located on the back of the device. **bintec R3000** has a 4-port Ethernet switch including a port with serial interface function, a DMZ/ETH5 interface, two ISDN interfaces and an ADSL interface.

The connections are arranged as follows:

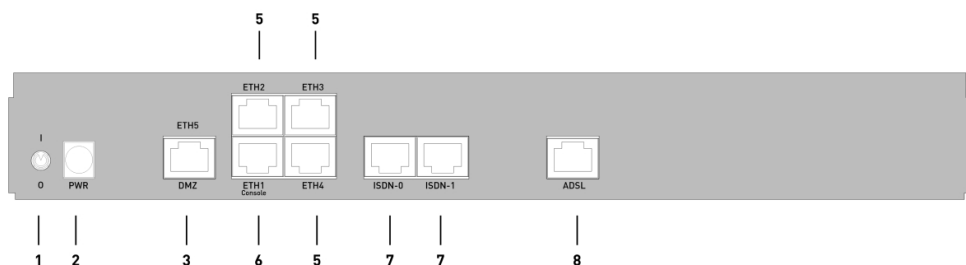

Fig. 26: Back of **bintec R3000**

Back of bintec R3000

1	I/O	Mains switch
2	PWR	Socket for plug-in power pack
3	DMZ/ETH5	Ethernet interface
5	ETH2 - ETH4	Ethernet interface
6	ETH1 / Console	Ethernet interface with serial interface function
7	ISDN-0 - ISDN-1	ISDN interface
8	ADSL	ADSL interface

3.4.5 Pin Assignments

3.4.5.1 Ethernet interface

The **bintec R3000** has an Ethernet interface with an integrated 4-port switch (ETH1 - ETH4) and a separate Ethernet interface (DMZ/ETH5).

The 4-port switch is used to connect individual PCs or other switches. The *ETH1/Console* interface can also be used as a serial interface. The DMZ/ETH5 interface can be used to connect an optional DSL modem or a DMZ.

The connection is made via an RJ45 socket.

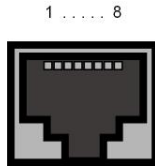

Fig. 27: Ethernet 10/100 Base-T interface (RJ45 socket)

The pin assignment for the Ethernet 10/100 Base-T interface (RJ45 socket) is as follows:

RJ45 socket for Ethernet connection

Pin	Function
1	TD +
2	TD -
3	RD +
4	Not used
5	Not used
6	RD -
7	Not used
8	Not used

The Ethernet 10/100 BASE-T interface does not have an Auto-MDI-X function.

The pin assignment for the Ethernet 10/100 Base-T interface (RJ45 socket) is as follows:

RJ45 socket for Ethernet connection or serial interface (console)

Pin	Function
1	TD + (Ethernet)
2	TD - (Ethernet)
3	RD + (Ethernet)
4	RX (console)
5	GND (console)
6	RD - (Ethernet)
7	GND (console)

Pin	Function
8	TX (console)

The combined serial Ethernet 10/100Base-T interface does not have an Auto-MDI-X function.

3.4.5.2 ADSL interface

The ADSL interface is connected via an RJ45 plug. The cable supplied connects the RJ45 plug needed for the device to an RJ45 plug provided for Annex A. The second cable supplied connects the RJ45 plug with an RJ45 plug for Annex B.

The following pins are used for the ADSL connection:

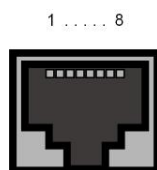

Fig. 28: ADSL interface (RJ45 socket)

The pin assignment for the ADSL interface (RJ45 socket) is as follows:

RJ45 socket for ADSL connection

Pin	Function
1	Not used
2	Not used
3	Not used
4	Line a
5	Line b
6	Not used
7	Not used
8	Not used

3.4.5.3 ISDN So interface

bintec R3000 has two additional ISDN-So interfaces, which can be used for back-up functions, for example.

The connection is made via an RJ45 socket:

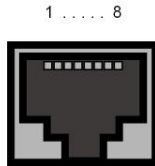

Fig. 29: ISDN So BRI interface (RJ45 socket)

The pin assignment for the ISDN So BRI interface (RJ45 socket) is as follows:

RJ45 socket for ISDN connection

Pin	Function
1	Not used
2	Not used
3	Transmit (+)
4	Receive (+)
5	Receive (-)
6	Transmit (-)
7	Not used
8	Not used

3.5 bintec R3000w

3.5.1 Scope of supply

Your device is supplied with the following parts:

- Cable sets/mains unit:
 - Ethernet cable
 - ISDN cable
 - Serial connecting cable
 - 2 DSL cables (for Annex A and for Annex B)
 - Plug-in power pack
- Antennas:
 - two standard antennas

- **bintec Companion CD**
- Documentation:
 - **Quick Install Guide** (printed)
 - **User's Guide** (on CD)
 - **Release Notes**, if required
 - **Safety precautions**

3.5.2 General Product Features

The general product features cover performance features and the technical prerequisites for installation and operation of your device.

The features are summarised in the following table:

General Product Features

Property	Value
Product name	bintec R3000w
Dimensions and weights:	
Equipment dimensions without cable (B x H x D):	295 mm x 45 mm x 160 mm + 8 mm (antenna socket)
Weight	approx. 1260 g
Transport weight (incl. documentation, cables, packaging)	approx. 2,6 kg
Memory	32 MB SDRAM, 8 MB flash ROM
LEDs	20 (1x Power, 1x Status, 5x2 Ethernet, 4x2 Function)
Power consumption of the device	max. 15 Watt, normally 13 Watt

Property	Value
Voltage supply	15 V AC 1.3 A EU PSU
Environmental requirements:	
Storage temperature	-20° to +70 °C
Operating temperature	0° to 40 °C
Relative atmospheric humidity	10 % to 90 % non-condensing in operation, 5 % to 95 % non-condensing when stored
Room classification	Only use in dry rooms.
Available interfaces:	
ADSL interface	Internal ADSL modem for Annex A and Annex B.
Ethernet IEEE 802.3 LAN (4-port switch), a port with serial interface function	Permanently installed (twisted pair only), 10/100 mbps, auto-sensing, MDIX; supports Baud rates: 1200, 2400, 4800, 9600, 19200, 38400, 57600, 115200 Baud
ISDN-WAN S0 (2)	Permanently installed
DMZ/ETH5	Additional Ethernet switch port
WLAN interface (antennas)	802.11b, 802.11g and 802.11a with Antenna Diversity. Data rates 1, 2, 5.5, 6, 9, 11, 12, 18, 24, 36, 48, 54 mbps 1-, 2-, 5.5-, 6-, 9-, 11-, 12-, 18-, 24-, 36-, 48-, 54 mbps
Available sockets:	
Serial interface V.24	RJ45 socket
Ethernet interface	RJ45 socket
ISDN interface	RJ45 socket
ADSL interface	RJ45 socket
Standards &	R&TTE Directive 1999/5/EC

Property	Value
Guidelines	CE symbol for all EU states
SAFERNET™ Security Technology	Community passwords, PAP, CHAP, MS-CHAP, MS-CHAP v.2, PPTP, PPPoE, PPPoA, Callback, Access Control Lists, CLID, NAT, SIF, MPPE Encryption, PPTP Encryption, VPN with PPTP or IPSec
Software supplied	BRICKware for Windows BRICKtools for Unix
Printed documentation supplied	Quick Reference
Online documentation	User's Guide BRICKware for Windows (Engl.) Software Reference (Engl.)



Note

Antenna Diversity

The two antennas do not have equality of access. One is used both to transmit and receive (marked as "main", "primary" or "1"; the antenna next to the power switch), the other is only used to receive. During reception, the AP (Access Point) checks which antenna is receiving a better signal. This is then used for decoding.

3.5.3 LEDs

The device LEDs provide information on certain activities and statuses of the device.

They are arranged as follows:

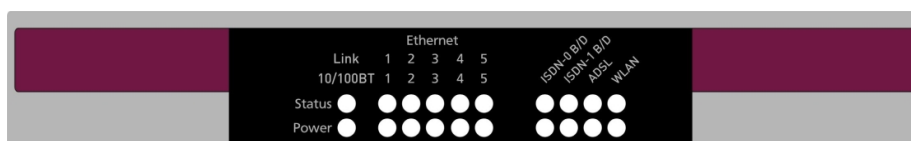

Fig. 30: LEDs on **bintec R3000w**

In operating mode, the LEDs display the following status information for your device:

LED status display

LED	State	Information
Power	on	The power supply is connected.
State	Permanently on or off	Error.
	flashing	The device is active.
ETH 1 to 5 Top row	on	The device is connected to the Ethernet.
	flashing	Data traffic via the Ethernet interface.
ETH 1 to 5 Bottom row	on	Data traffic at 100 mbps.
	off	Data traffic at 10 mbps.
ISDN-0 B/D Top row	on	ISDN D-channel is active.
ISDN-0 B/D Bottom row	on	One ISDN B channel is active.
	flashing	Both ISDN B channels are active.
ISDN-1 B/D Top row	on	ISDN D-channel is active.
ISDN-1 B/D Bottom row	on	One ISDN B channel is active.
	flashing	Both ISDN B channels are active.
ADSL	flashing	The device synchronises with the DSLAM of the

LED	State	Information
Top row		ADSL provider.
	on	The device has successfully synchronised with the DSLAM of the ADSL provider.
ADSL Bottom row	flashing	Data traffic via the ADSL interface.
	synchronous flashing	ADSL Handshake.
	asynchronous flashing	ADSL system error.
WLAN Top row	flashing	Data traffic via the WLAN interface.
WLAN Bottom row	slow flashing	The WLAN module is active.
	on	At least one WLAN client is connected.

3.5.4 Connections

All the connections are located on the back of the device. **bintec R3000w** has a 4-port Ethernet switch including a port with serial interface function, a DMZ/ETH5 interface, two ISDN interfaces and an ADSL interface.

The connections are arranged as follows:

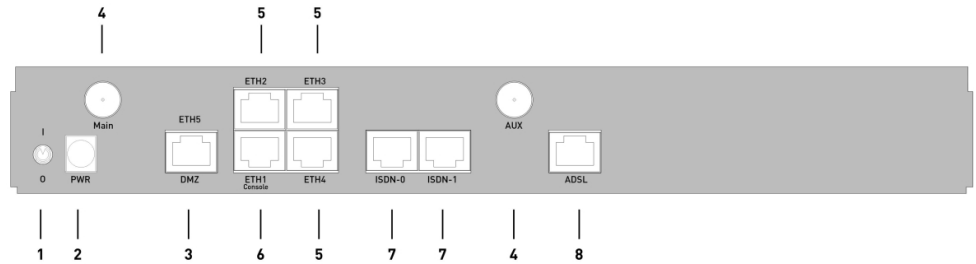

Fig. 31: Back of **bintec R3000w**

Back of bintec R3000w

1	I/O	Mains switch
2	PWR	Socket for plug-in power pack
3	DMZ/ETH5	Ethernet interface
4	Main and AUX	RSMA connection
5	ETH2 - ETH4	Ethernet interface
6	ETH1 / Console	Ethernet interface with serial interface function
7	ISDN-0 - ISDN-1	ISDN interface
8	ADSL	ADSL interface

3.5.5 Pin Assignments

3.5.5.1 Ethernet interface

The **bintec R3000w** has an Ethernet interface with an integrated 4-port switch (ETH1 - ETH4) and a separate Ethernet interface (DMZ/ETH5).

The 4-port switch is used to connect individual PCs or other switches. The *ETH1/Console* interface can also be used as a serial interface. The DMZ/ETH5 interface can be used to connect an optional DSL modem or a DMZ.

The connection is made via an RJ45 socket.

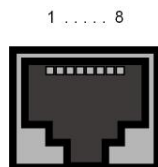

Fig. 32: Ethernet 10/100 Base-T interface (RJ45 socket)

The pin assignment for the Ethernet 10/100 Base-T interface (RJ45 socket) is as follows:

RJ45 socket for Ethernet connection

Pin	Function
1	TD +
2	TD -
3	RD +
4	Not used
5	Not used
6	RD -
7	Not used
8	Not used

The Ethernet 10/100 BASE-T interface does not have an Auto-MDI-X function.

The pin assignment for the Ethernet 10/100 Base-T interface (RJ45 socket) is as follows:

RJ45 socket for Ethernet connection or serial interface (console)

Pin	Function
1	TD + (Ethernet)
2	TD - (Ethernet)
3	RD + (Ethernet)
4	RX (console)
5	GND (console)
6	RD - (Ethernet)
7	GND (console)
8	TX (console)

The combined serial Ethernet 10/100Base-T interface does not have an Auto-MDI-X function.

3.5.5.2 ADSL interface

The ADSL interface is connected via an RJ45 plug. The cable supplied connects the RJ45 plug needed for the device to an RJ45 plug provided for Annex A. The second cable supplied connects the RJ45 plug with an RJ45 plug for Annex B.

The following pins are used for the ADSL connection:

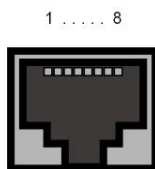

Fig. 33: ADSL interface (RJ45 socket)

The pin assignment for the ADSL interface (RJ45 socket) is as follows:

RJ45 socket for ADSL connection

Pin	Function
1	Not used
2	Not used
3	Not used
4	Line a
5	Line b
6	Not used
7	Not used
8	Not used

3.5.5.3 ISDN So interface

bintec R3000w has two additional ISDN-So interfaces, which can be used for back-up functions, for example.

The connection is made via an RJ45 socket:

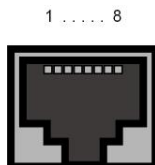

Fig. 34: ISDN So BRI interface (RJ45 socket)

The pin assignment for the ISDN So BRI interface (RJ45 socket) is as follows:

RJ45 socket for ISDN connection

Pin	Function
1	Not used
2	Not used

Pin	Function
3	Transmit (+)
4	Receive (+)
5	Receive (-)
6	Transmit (-)
7	Not used
8	Not used

3.6 bintec R3400

3.6.1 Scope of supply

Your device is supplied with the following parts:

- Cable sets/mains unit:
 - Ethernet cable
 - ISDN cable
 - Serial connecting cable
 - DSL cable
 - Plug-in power pack
- **bintec Companion CD**
- Documentation:
 - **Quick Install Guide** (printed)
 - **User's Guide** (on CD)
 - **Release Notes**, if required
 - **Safety precautions**

3.6.2 General Product Features

The general product features cover performance features and the technical prerequisites for installation and operation of your device.

The features are summarised in the following table:

General Product Features

Property	Value
Product name	bintec R3400
Dimensions and weights:	
Equipment dimensions without cable (B x H x D):	295 mm x 45 mm x 160 mm
Weight	approx. 1260 g
Transport weight (incl. documentation, cables, packaging)	approx. 2,6 kg
Memory	32 MB SDRAM, 8 MB flash ROM
LEDs	18 (1x Power, 1x Status, 5x2 Ethernet, 3x2 Function)
Power consumption of the device	max. 15 Watt, normally 10 Watt
Voltage supply	15 V AC 1.3 A EU PSU
Environmental requirements:	
Storage temperature	-20° to +70 °C
Operating temperature	0° to 40 °C
Relative atmospheric humidity	10 % to 90 % non-condensing in operation, 5 % to 95 % non-condensing when stored
Room classification	Only use in dry rooms.
Available interfaces:	

Property	Value
SHDSL interface	Internal SHDSL 4-wire modem for Annex A and Annex B. Bonding technology with 2-wire/4-wire as an inverse multiplexer - performed over IMA in accordance with the ATM forum.
Ethernet IEEE 802.3 LAN (4-port switch), a port with serial interface function	Permanently installed (twisted pair only), 10/100 mbps, auto-sensing, MDIX; supports Baud rates: 1200, 2400, 4800, 9600, 19200, 38400, 57600, 115200 Baud
ISDN-WAN S0	Permanently installed
DMZ/ETH5	Additional Ethernet switch port
Available sockets:	
Serial interface V.24	RJ45 socket
Ethernet interface	RJ45 socket
ISDN interface	RJ45 socket
SHDSL interface	RJ45 socket
Standards & Guidelines	R&TTE Directive 1999/5/EC CE symbol for all EU states
SAFERNET™ Security Technology	Community passwords, PAP, CHAP, MS-CHAP, MS-CHAP v.2, PPTP, PPPoE, PPPoA, Callback, Access Control Lists, CLID, NAT, SIF, MPPE Encryption, PPTP Encryption, VPN with PPTP or IPSec
Software supplied	BRICKware for Windows BRICKtools for Unix
Printed documentation supplied	Quick Reference
Online documentation	User's Guide BRICKware for Windows (Engl.)

Property	Value
	Software Reference (Engl.)

3.6.3 LEDs

The device LEDs provide information on certain activities and statuses of the device.

They are arranged as follows:

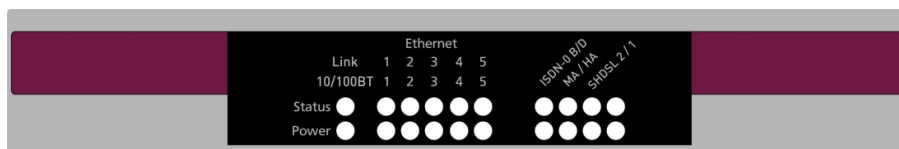

Fig. 35: LEDs on **bintec R3400**

In operating mode, the LEDs display the following status information for your device:

LED status display

LED	State	Information
Power	on	The power supply is connected.
State	Permanently on or off	Error.
	flashing	The device is active.
ETH 1 to 5 Top row	on	The device is connected to the Ethernet.
	flashing	Data traffic via the Ethernet interface.
ETH 1 to 5 Bottom row	on	Data traffic at 100 mbps.
	off	Data traffic at 10 mbps.
ISDN-0 B/D Top row	on	ISDN D-channel is active.

LED	State	Information
ISDN-0 B/D Bottom row	on	One ISDN B channel is active.
	flashing	Both ISDN B channels are active.
MA / HA Top row	flashing	BRRP packets are received.
MA / HA Bottom row	on	A user is logged in to the system (e.g. over Telnet).
SHDSL-2/1 Top row	on	The wire pair 4-5 on the SHDSL line has successfully synchronised with the DSLAM of the SHDSL provider.
	flashing	Data traffic over the SHDSL wire pair 4-5.
SHDSL-2/1 Top row	on	The wire pair 7-8 on the SHDSL line has successfully synchronised with the DSLAM of the SHDSL provider.
	flashing	Data traffic over the SHDSL wire pair 7-8.

3.6.4 Connections

All the connections are located on the back of the device. **bintec R3400** has a 4-port Ethernet switch including a port with serial interface function, a DMZ/ETH5 interface, an ISDN interface and an SHDSL interface.

The connections are arranged as follows:

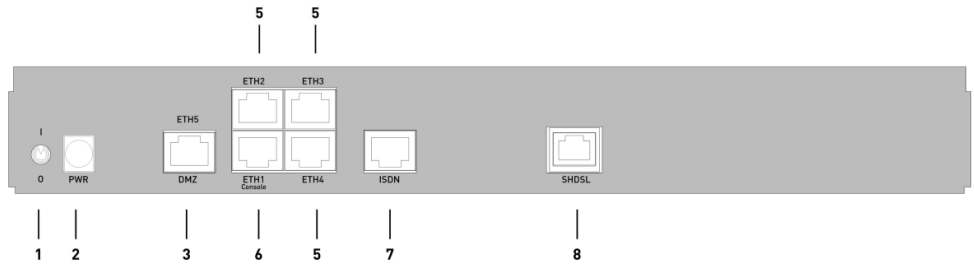

Fig. 36: Back of **bintec R3400**

Back of bintec R3400

1	I/O	Mains switch
2	PWR	Socket for plug-in power pack
3	DMZ/ETH5	Ethernet interface
5	ETH2 - ETH4	Ethernet interface
6	ETH1 / Console	Ethernet interface with serial interface function
7	ISDN	ISDN interface
8	SHDSL	SHDSL interface

3.6.5 Pin Assignments

3.6.5.1 Ethernet interface

The **bintec R3400** has an Ethernet interface with an integrated 4-port switch (ETH1 - ETH4) and a separate Ethernet interface (DMZ/ETH5).

The 4-port switch is used to connect individual PCs or other switches. The *ETH1/Console* interface can also be used as a serial interface. The DMZ/ETH5 interface can be used to connect an optional DSL modem or a DMZ.

The connection is made via an RJ45 socket.

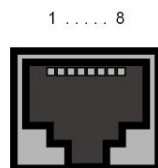

Fig. 37: Ethernet 10/100 Base-T interface (RJ45 socket)

The pin assignment for the Ethernet 10/100 Base-T interface (RJ45 socket) is as follows:

RJ45 socket for Ethernet connection

Pin	Function
1	TD +
2	TD -
3	RD +
4	Not used
5	Not used
6	RD -
7	Not used
8	Not used

The Ethernet 10/100 BASE-T interface does not have an Auto-MDI-X function.

The pin assignment for the Ethernet 10/100 Base-T interface (RJ45 socket) is as follows:

RJ45 socket for Ethernet connection or serial interface (console)

Pin	Function
1	TD + (Ethernet)
2	TD - (Ethernet)
3	RD + (Ethernet)
4	RX (console)
5	GND (console)
6	RD - (Ethernet)
7	GND (console)
8	TX (console)

The combined serial Ethernet 10/100Base-T interface does not have an Auto-MDI-X function.

3.6.5.2 SHDSL interface

The SHDSL interface is connected via an RJ45 plug. The cable supplied connects the RJ45 plug needed for the device to an RJ45 plug needed for the SHDSL connection.

The following pins are used for the SHDSL connection:

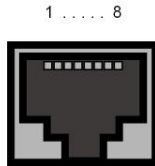

Fig. 38: SHDSL interface (RJ45 socket)

The pin assignment for the SHDSL interface (RJ45 socket) is as follows:

RJ45 socket for SHDSL connection

Pin	Function
1	Not used
2	Not used
3	Not used
4	Line a1
5	Line b1
6	Not used
7	Line a2
8	Line b2

3.6.5.3 ISDN So interface

bintec R3400 has an additional ISDN-So interface, which can be used for back-up functions, for example.

The connection is made via an RJ45 socket:

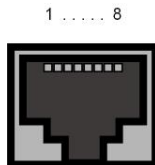

Fig. 39: ISDN So BRI interface (RJ45 socket)

The pin assignment for the ISDN So BRI interface (RJ45 socket) is as follows:

RJ45 socket for ISDN connection

Pin	Function
1	Not used
2	Not used

Pin	Function
3	Transmit (+)
4	Receive (+)
5	Receive (-)
6	Transmit (-)
7	Not used
8	Not used

3.7 bintec R3800

3.7.1 Scope of supply

Your device is supplied with the following parts:

- Cable sets/mains unit:
 - Ethernet cable
 - ISDN cable
 - Serial connecting cable
 - DSL cable
 - Splitter (Y adapter)
 - Plug-in power pack
- **bintec Companion CD**
- Documentation:
 - **Quick Install Guide** (printed)
 - **User's Guide** (on CD)
 - **Release Notes**, if required
 - **Safety precautions**

3.7.2 General Product Features

The general product features cover performance features and the technical prerequisites for installation and operation of your device.

The features are summarised in the following table:

General Product Features

Property	Value
Product name	bintec R3800
Dimensions and weights:	
Equipment dimensions without cable (B x H x D):	295 mm x 45 mm x 160 mm
Weight	approx. 1260 g
Transport weight (incl. documentation, cables, packaging)	approx. 2,6 kg
Memory	32 MB SDRAM, 8 MB flash ROM
LEDs	20 (1x Power, 1x Status, 5x2 Ethernet, 4x2 Function)
Power consumption of the device	max. 15 Watt, normally 12 Watt
Voltage supply	15 V AC 1.3 A EU PSU
Environmental requirements:	
Storage temperature	-20° to +70 °C
Operating temperature	0° to 40 °C
Relative atmospheric humidity	10 % to 90 % non-condensing in operation, 5 % to 95 % non-condensing when stored
Room classification	Only use in dry rooms.

Property	Value
Available interfaces:	
SHDSL interface	Internal SHDSL 8-wire modem for Annex A and Annex B. Bonding technology with 2-wire/4-wire/6-wire/8-wire as an inverse multiplexer - performed over IMA in accordance with the ATM forum.
Ethernet IEEE 802.3 LAN (4-port switch), a port with serial interface function	Permanently installed (twisted pair only), 10/100 mbps, auto-sensing, MDIX; supports Baud rates: 1200, 2400, 4800, 9600, 19200, 38400, 57600, 115200 Baud
ISDN-WAN S0	Permanently installed
DMZ/ETH5	Additional Ethernet switch port
Available sockets :	
Serial interface V.24	RJ45 socket
Ethernet interface	RJ45 socket
ISDN interface	RJ45 socket
SHDSL interface	RJ45 socket
Standards & Guidelines	R&TTE Directive 1999/5/EC CE symbol for all EU states
SAFERNET™ Security Technology	Community passwords, PAP, CHAP, MS-CHAP, MS-CHAP v.2, PPTP, PPPoE, PPPoA, Callback, Access Control Lists, CLID, NAT, SIF, MPPE Encryption, PPTP Encryption, VPN with PPTP or IPsec
Software supplied	BRICKware for Windows BRICKtools for Unix
Printed documentation supplied	Quick Reference
Online documentation	User's Guide

Property	Value
	BRICKware for Windows (Engl.)
	Software Reference (Engl.)

3.7.3 LEDs

The device LEDs provide information on certain activities and statuses of the device.

They are arranged as follows:

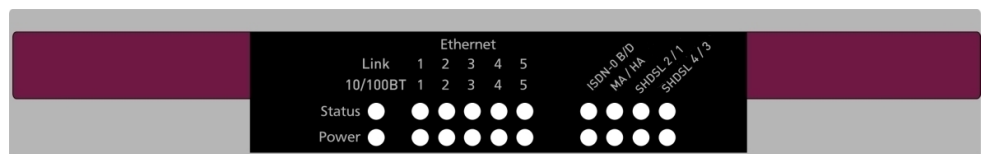

Fig. 40: LEDs on **bintec R3800**

In operating mode, the LEDs display the following status information for your device:

LED status display

LED	State	Information
Power	on	The power supply is connected.
State	Permanently on or off	Error.
	flashing	The device is active.
ETH 1 to 5 Top row	on	The device is connected to the Ethernet.
	flashing	Data traffic via the Ethernet interface.
ETH 1 to 5 Bottom row	on	Data traffic at 100 mbps.
	off	Data traffic at 10 mbps.
ISDN-0 B/D	on	ISDN D-channel is active.

LED	State	Information
Top row		
ISDN-0 B/D	on	One ISDN B channel is active.
Bottom row		
	flashing	Both ISDN B channels are active.
MA / HA	flashing	BRRP packets are received.
Top row		
MA / HA	on	A user is logged in to the system (e.g. over Telnet).
Bottom row		
SHDSL-2/1	on	The wire pair 4-5 on the SHDSL line has successfully synchronised with the DSLAM of the SHDSL provider.
Top row		
	flashing	Data traffic over the SHDSL wire pair 4-5.
SHDSL-2/1	on	The wire pair 7-8 on the SHDSL line has successfully synchronised with the DSLAM of the SHDSL provider.
Top row		
	flashing	Data traffic over the SHDSL wire pair 7-8.
SHDSL-4/3	on	The wire pair 3-6 on the SHDSL line has successfully synchronised with the DSLAM of the SHDSL provider.
Top row		
	flashing	Data traffic over the SHDSL wire pair 3-6.
SHDSL-4/3	on	The wire pair 1-2 on the SHDSL line has successfully synchronised with the DSLAM of the SHDSL provider.
Top row		
	flashing	Data traffic over the SHDSL wire pair 1-2.

3.7.4 Connections

All the connections are located on the back of the device. **bintec R3800** has a 4-port Ethernet switch including a port with serial interface function, a DMZ/ETH5 interface, an ISDN interface and an SHDSL interface.

The connections are arranged as follows:

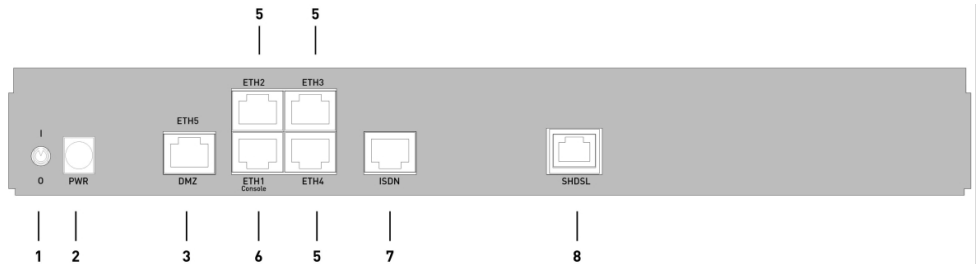

Fig. 41: Back of **bintec R3800**

Back of bintec R3800

1	I/O	Mains switch
2	PWR	Socket for plug-in power pack
3	DMZ/ETH5	Ethernet interface
5	ETH2 - ETH4	Ethernet interface
6	ETH1 / Console	Ethernet interface with serial interface function
7	ISDN	ISDN interface
8	SHDSL	SHDSL interface

3.7.5 Pin Assignments

3.7.5.1 Ethernet interface

The **bintec R3800** has an Ethernet interface with an integrated 4-port switch (ETH1 - ETH4) and a separate Ethernet interface (DMZ/ETH5).

The 4-port switch is used to connect individual PCs or other switches. The *ETH1/Console* interface can also be used as a serial interface. The DMZ/ETH5 interface can be used to connect an optional DSL modem or a DMZ.

The connection is made via an RJ45 socket.

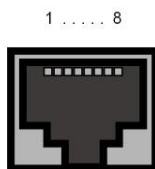

Fig. 42: Ethernet 10/100 Base-T interface (RJ45 socket)

The pin assignment for the Ethernet 10/100 Base-T interface (RJ45 socket) is as follows:

RJ45 socket for Ethernet connection

Pin	Function
1	TD +
2	TD -
3	RD +
4	Not used
5	Not used
6	RD -
7	Not used
8	Not used

The Ethernet 10/100 BASE-T interface does not have an Auto-MDI-X function.

The pin assignment for the Ethernet 10/100 Base-T interface (RJ45 socket) is as follows:

RJ45 socket for Ethernet connection or serial interface (console)

Pin	Function
1	TD + (Ethernet)
2	TD - (Ethernet)
3	RD + (Ethernet)
4	RX (console)
5	GND (console)
6	RD - (Ethernet)
7	GND (console)
8	TX (console)

The combined serial Ethernet 10/100Base-T interface does not have an Auto-MDI-X function.

3.7.5.2 SHDSL interface

The SHDSL interface is connected via an RJ45 plug. The cable supplied connects the RJ45 plug needed for the device to an RJ45 plug needed for the SHDSL connection.

The following pins are used for the SHDSL connection:

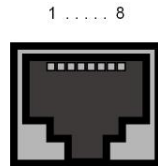

Fig. 43: SHDSL interface (RJ45 socket)

The pin assignment for the SHDSL interface (RJ45 socket) is as follows:

RJ45 socket for SHDSL connection

Pin	Function
1	Line a4
2	Line b4
3	Line a3
4	Line a1
5	Line b1
6	Line b3
7	Line a2
8	Line b2

3.7.5.3 ISDN So interface

bintec R3800 has an additional ISDN-So interface, which can be used for back-up functions, for example.

The connection is made via an RJ45 socket:

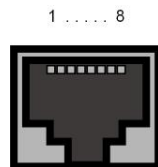

Fig. 44: ISDN So BRI interface (RJ45 socket)

The pin assignment for the ISDN So BRI interface (RJ45 socket) is as follows:

RJ45 socket for ISDN connection

Pin	Function
1	Not used
2	Not used
3	Transmit (+)
4	Receive (+)
5	Receive (-)
6	Transmit (-)
7	Not used
8	Not used

3.8 bintec R4100

3.8.1 Scope of supply

Your device is supplied with the following parts:

- Cable sets/mains unit:
 - Ethernet cable
 - ISDN cable
 - Serial connecting cable
 - Splitter (Y adapter) serial/Ethernet
 - Plug-in power pack
- **bintec Companion CD**
- Documentation:
 - **Quick Install Guide** (printed)
 - **User's Guide** (on CD)
 - **Release Notes**, if required
 - **Safety precautions**

3.8.2 General Product Features

The general product features cover performance features and the technical prerequisites for installation and operation of your device.

The features are summarised in the following table:

General Product Features

Property	Value
Product name	bintec R4100
Dimensions and weights:	
Equipment dimensions without cable (B x H x D):	295 mm x 45 mm x 160 mm
Weight	approx. 1260 g
Transport weight (incl. documentation, cables, packaging)	approx. 2,6 kg
Memory	32 MB SDRAM, 8 MB flash ROM
LEDs	20 (1x Power, 1x Status, 5x2 Ethernet, 4x2 Function)
Power consumption of the device	max. 15 Watt, normally 10 Watt
Voltage supply	24 V DC 1 A EU PSU
Environmental requirements:	
Storage temperature	-20° to +70 °C
Operating temperature	0° to 40 °C

Property	Value
Relative atmospheric humidity	10 % to 90 % non-condensing in operation, 5 % to 95 % non-condensing when stored
Room classification	Only use in dry rooms.
Available interfaces:	
Ethernet IEEE 802.3 LAN (4-port switch), a port with serial interface function	Permanently installed (twisted pair only), 10/100 mbps, auto-sensing, MDIX; supports Baud rates: 1200, 2400, 4800, 9600, 19200, 38400, 57600, 115200 Baud
ISDN-WAN S0 (2)	Permanently installed
ISDN-PRI (2)	Permanently installed
DMZ/ETH5	Additional Ethernet switch port
Available sockets:	
Serial interface V.24	RJ45 socket
Ethernet interface	RJ45 socket
ISDN interface	RJ45 socket
ISDN-PRI interface	RJ45 socket
Standards & Guidelines	R&TTE Directive 1999/5/EC CE symbol for all EU states
SAFERNET™ Security Technology	Community passwords, PAP, CHAP, MS-CHAP, MS-CHAP v.2, PPTP, PPPoE, PPPoA, Callback, Access Control Lists, CLID, NAT, SIF, MPPE Encryption, PPTP Encryption, VPN with PPTP or IPSec
Software supplied	BRICKware for Windows BRICKtools for Unix
Printed documentation supplied	Quick Reference

Property	Value
Online documentation	User's Guide BRICKware for Windows (Engl.) Software Reference (Engl.)

3.8.3 LEDs

The device LEDs provide information on certain activities and statuses of the device.

They are arranged as follows:

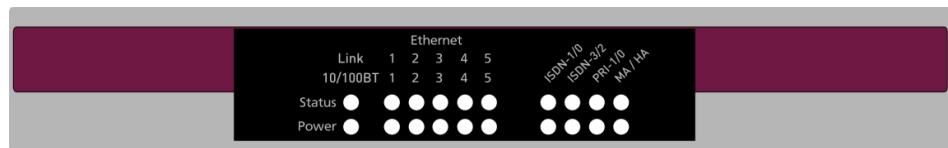

Fig. 45: LEDs on **bintec R4100**

In operating mode, the LEDs display the following status information for your device:

LED status display

LED	State	Information
Power	on	The power supply is connected.
State	Permanently on or off	Error.
	flashing	The device is active.
ETH 1 to 5 Top row	on	The device is connected to the Ethernet.
	flashing	Data traffic via the Ethernet interface.
ETH 1 to 5 Bottom row	on	Data traffic at 100 mbps.
	off	Data traffic at 10 mbps.

LED	State	Information
ISDN-1/0 Top row	on	ISDN-0: ISDN D-channel is active.
	flashing	ISDN-0: At least one ISDN B channel is active.
ISDN-1/0 Bottom row	on	ISDN-1: ISDN D-channel is active.
	flashing	ISDN-1: At least one ISDN B channel is active.
ISDN-3/2 Top row	on	ISDN-2: ISDN D-channel is active.
	flashing	ISDN-2: At least one ISDN B channel is active.
ISDN-3/2 Bottom row	on	ISDN-3: ISDN D-channel is active.
	flashing	ISDN-3: At least one ISDN B channel is active.
PRI 1/0 Top row	on	PRI-0: ISDN D-channel is active.
	flashing	PRI-0: At least one ISDN B channel is active.
PRI 1/0 Bottom row	on	PRI-1: ISDN D-channel is active.
	flashing	PRI-1: At least one ISDN B channel is active.
MA / HA Top row	flashing	BRRP packets are received.
MA / HA Bottom row	on	A user is logged in to the system (e.g. over Tel-net).

3.8.4 Connections

All the connections are located on the back of the device. **bintec R4100** has a 4-port Ethernet switch including a port with serial interface function, a DMZ/ETH5 interface, four ISDN interfaces and two ISDN PRI interfaces.

The connections are arranged as follows:

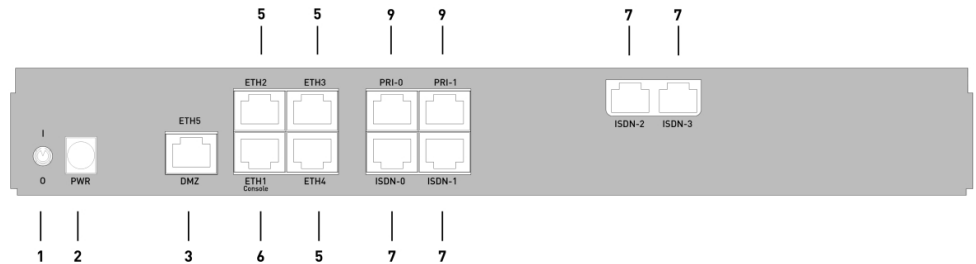

Fig. 46: Back of **bintec R4100**

Back of bintec R4100

1	I/O	Mains switch
2	PWR	Socket for plug-in power pack
3	DMZ/ETH5	Ethernet interface
5	ETH2 - ETH4	Ethernet interface
6	ETH1 / Console	Ethernet interface with serial interface function
7	ISDN-0 - ISDN-3	ISDN interface
9	PRI-0 - PRI-1	ISDN-PRI interface

3.8.5 Pin Assignments

3.8.5.1 Ethernet interface

The **bintec R4100** has an Ethernet interface with an integrated 4-port switch (ETH1 - ETH4) and a separate Ethernet interface (DMZ/ETH5).

The 4-port switch is used to connect individual PCs or other switches. The *ETH1/Console* interface can also be used as a serial interface. The DMZ/ETH5 interface can be used to connect an optional DSL modem or a DMZ.

The connection is made via an RJ45 socket.

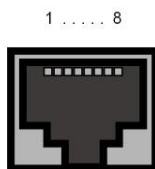

Fig. 47: Ethernet 10/100 Base-T interface (RJ45 socket)

The pin assignment for the Ethernet 10/100 Base-T interface (RJ45 socket) is as follows:

RJ45 socket for Ethernet connection

Pin	Function
1	TD +
2	TD -
3	RD +
4	Not used
5	Not used
6	RD -
7	Not used
8	Not used

The Ethernet 10/100 BASE-T interface does not have an Auto-MDI-X function.

The pin assignment for the Ethernet 10/100 Base-T interface (RJ45 socket) is as follows:

RJ45 socket for Ethernet connection or serial interface (console)

Pin	Function
1	TD + (Ethernet)
2	TD - (Ethernet)
3	RD + (Ethernet)
4	RX (console)
5	GND (console)
6	RD - (Ethernet)
7	GND (console)
8	TX (console)

The combined serial Ethernet 10/100Base-T interface does not have an Auto-MDI-X function.

3.8.5.2 ISDN So interface

bintec R4100 has an additional ISDN-So interface, which can be used for back-up functions, for example.

The connection is made via an RJ45 socket:

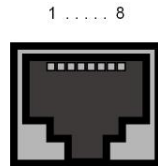

Fig. 48: ISDN So BRI interface (RJ45 socket)

The pin assignment for the ISDN So BRI interface (RJ45 socket) is as follows:

RJ45 socket for ISDN connection

Pin	Function
1	Not used
2	Not used
3	Transmit (+)
4	Receive (+)
5	Receive (-)
6	Transmit (-)
7	Not used
8	Not used

3.8.5.3 ISDN-PRI interface

Both of the ISDN PRI interfaces are connected via an RJ45 plug. The cable supplied connects the RJ45 plug needed for the device to an RJ45 plug needed for the PRI connection.

The following pins are used for the connection:

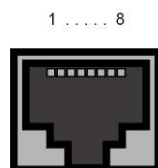

Fig. 49: ISDN PRI interface (RJ45 socket)

The pin assignment for the ISDN PRI interface (RJ45 socket) is as follows:

RJ45 socket for ISDN PRI connection

Pin	Function
1	T+
2	T-
3	Not used
4	R+
5	R-
6	Not used
7	Not used
8	Not used

Note for NTs in Germany



Note

In Germany, "Transmit" (NT-->TE) is often designated "S2Mab" (a and b) on the plug and "Receive" (TE-->NT) "S2Man" (a and b).

3.9 bintec R4300

3.9.1 Scope of supply

Your device is supplied with the following parts:

- Cable sets/mains unit:
 - Ethernet cable
 - ISDN cable
 - Serial connecting cable
 - Plug-in power pack
 - X.21 DTE (optional)
 - X.21 DCE (optional)
 - V.35 DTE (optional)

- **bintec Companion CD**
- Documentation:
 - **Quick Install Guide** (printed)
 - **User's Guide** (on CD)
 - **Release Notes**, if required
 - **Safety precautions**

3.9.2 General Product Features

The general product features cover performance features and the technical prerequisites for installation and operation of your device.

The features are summarised in the following table:

General Product Features

Property	Value
Product name	bintec R4300
Dimensions and weights:	
Equipment dimensions without cable (B x H x D):	295 mm x 45 mm x 160 mm
Weight	approx. 1260 g
Transport weight (incl. documentation, cables, packaging)	approx. 2,6 kg
Memory	32 MB SDRAM, 8 MB flash ROM
LEDs	20 (1x Power, 1x Status, 5x2 Ethernet, 4x2 Function)
Power consumption of the device	max. 15 Watt, normally 13 Watt

Property	Value
Voltage supply	15 V AC 1.3 A EU PSU
Environmental requirements:	
Storage temperature	-20° to +70 °C
Operating temperature	0° to 40 °C
Relative atmospheric humidity	10 % to 90 % non-condensing in operation, 5 % to 95 % non-condensing when stored
Room classification	Only use in dry rooms.
Available interfaces:	
Ethernet IEEE 802.3 LAN (4-port switch), a port with serial interface function	Permanently installed (twisted pair only), 10/100 mbps, auto-sensing, MDIX; supports Baud rates: 1200, 2400, 4800, 9600, 19200, 38400, 57600, 115200 Baud
ISDN-WAN S0 (2)	Permanently installed
DMZ/ETH5	Additional Ethernet switch port
X.21 interface (2)	Permanently installed
Available sockets:	
Serial interface V.24	RJ45 socket
Ethernet interface	RJ45 socket
ISDN interface	RJ45 socket
X.21 interface	RJ45 socket
Standards & Guidelines	R&TTE Directive 1999/5/EC CE symbol for all EU states
SAFERNET™ Security Technology	Community passwords, PAP, CHAP, MS-CHAP, MS-CHAP v.2, PPTP, PPPoE, PPPoA, Callback, Access Control Lists, CLID,

Property	Value
	NAT, SIF, MPPE Encryption, PPTP Encryption, VPN with PPTP or IPSec
Software supplied	BRICKware for Windows BRICKtools for Unix
Printed documentation supplied	Quick Reference
Online documentation	User's Guide BRICKware for Windows (Engl.) Software Reference (Engl.)

3.9.3 LEDs

The device LEDs provide information on certain activities and statuses of the device.

They are arranged as follows:

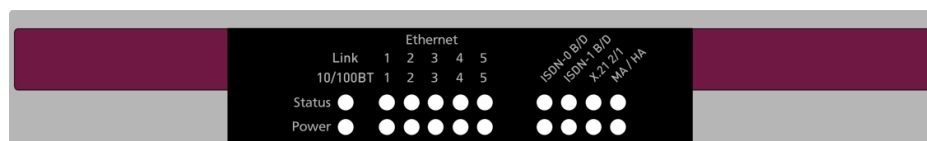

Fig. 50: LEDs on **bintec R4300**

In operating mode, the LEDs display the following status information for your device:

LED status display

LED	State	Information
Power	on	The power supply is connected.
State	Permanently on or off	Error.
	flashing	The device is active.
ETH 1 to 5 Top row	on	The device is connected to the Ethernet.

LED	State	Information
	flashing	Data traffic via the Ethernet interface.
ETH 1 to 5 Bottom row	on	Data traffic at 100 mbps.
	off	Data traffic at 10 mbps.
ISDN-0 B/D Top row	on	ISDN D-channel is active.
ISDN-0 B/D Bottom row	on	One ISDN B channel is active.
	flashing	Both ISDN B channels are active.
ISDN-1 B/D Top row	on	ISDN D-channel is active.
ISDN-1 B/D Bottom row	on	One ISDN B channel is active.
	flashing	Both ISDN B channels are active.
X.21 2/1 Top row	on	X.21 1: Connection is set up.
	flashing	X.21 1: Data traffic.
X.21 2/1 Bottom row	on	X.21 2: Connection is set up.
	flashing	X.21 2: Data traffic.
MA / HA Top row	flashing	BRRP packets are received.

LED	State	Information
MA / HA Bottom row	on	A user is logged in to the system (e.g. over Telnet).

3.9.4 Connections

All the connections are located on the back of the device. **bintec R4300** has a 4-port Ethernet switch including a port with serial interface function, a DMZ/ETH5 interface, two ISDN interfaces and two X.21 interfaces.

The connections are arranged as follows:

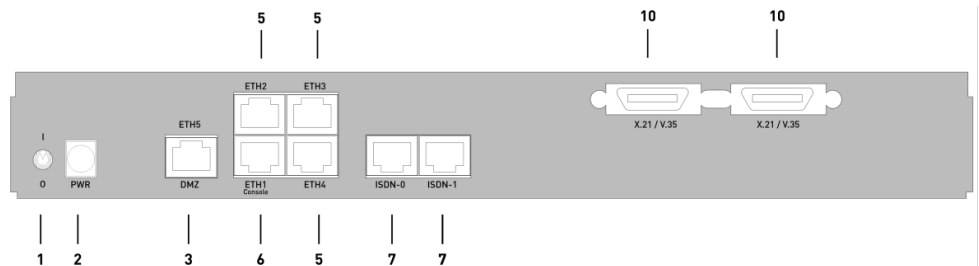

Fig. 51: Back of **bintec R4300**

Back of bintec R4300

1	I/O	Mains switch
2	PWR	Socket for plug-in power pack
3	DMZ/ETH5	Ethernet interface
5	ETH2 - ETH4	Ethernet interface
6	ETH1 / Console	Ethernet interface with serial interface function
7	ISDN-0 - ISDN-1	ISDN interface
10	X.21 / V.35	X.21 interface

3.9.5 Pin Assignments

3.9.5.1 Ethernet interface

The **bintec R4300** has an Ethernet interface with an integrated 4-port switch (ETH1 - ETH4) and a separate Ethernet interface (DMZ/ETH5).

The 4-port switch is used to connect individual PCs or other switches. The *ETH1/Console*

interface can also be used as a serial interface. The DMZ/ETH5 interface can be used to connect an optional DSL modem or a DMZ.

The connection is made via an RJ45 socket.

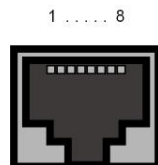

Fig. 52: Ethernet 10/100 Base-T interface (RJ45 socket)

The pin assignment for the Ethernet 10/100 Base-T interface (RJ45 socket) is as follows:

RJ45 socket for Ethernet connection

Pin	Function
1	TD +
2	TD -
3	RD +
4	Not used
5	Not used
6	RD -
7	Not used
8	Not used

The Ethernet 10/100 BASE-T interface does not have an Auto-MDI-X function.

The pin assignment for the Ethernet 10/100 Base-T interface (RJ45 socket) is as follows:

RJ45 socket for Ethernet connection or serial interface (console)

Pin	Function
1	TD + (Ethernet)
2	TD - (Ethernet)
3	RD + (Ethernet)
4	RX (console)
5	GND (console)
6	RD - (Ethernet)
7	GND (console)
8	TX (console)

The combined serial Ethernet 10/100Base-T interface does not have an Auto-MDI-X function.

3.9.5.2 ISDN So interface

bintec R4300 has two additional ISDN-So interfaces, which can be used for back-up functions, for example.

The connection is made via an RJ45 socket:

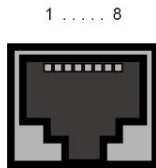

Fig. 53: ISDN So BRI interface (RJ45 socket)

The pin assignment for the ISDN So BRI interface (RJ45 socket) is as follows:

RJ45 socket for ISDN connection

Pin	Function
1	Not used
2	Not used
3	Transmit (+)
4	Receive (+)
5	Receive (-)
6	Transmit (-)
7	Not used
8	Not used

3.9.5.3 X.21 interface

bintec R4300 has two X.21 interfaces

The connection is made via a 26-pole mini Delta ribbon socket:

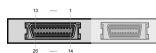

Fig. 54: X.21 interface (26-pole mini Delta ribbon socket)

The 26-pole mini Delta ribbon socket has the following pin assignment:

Pin assignment of 26-pole mini Delta ribbon socket

Signal	Pin no.	X.21 (DB-15)	X.21 (DB-15)	V.35 (M34)	V.35 (M34)	V.36 (DB-37)	V.36 (DB-37)
		DTE	DCE	DTE	DCE	DTE	DCE
Shield	A1 (1)	1	1	A	A	1	1
GND	A2 (2)	8	8	B	B	19	19
TxD (B)	A3 (3)	9	11	S	T	22	24
TxD (A)	A4 (4)	2	4	P	R	4	6
RxD (B)	A5 (5)	11	9	T	S	24	22
RxD (A)	A6 (6)	4	2	R	P	6	4
RTS (B)	A7 (7)	10	12			25	27
RTS (A)	A(8)	3	5	C	D	7	9
CBS (B)	A9 (9)	12	10			27	25
CBS (A)	A10 (10)	5	3	D	C	9	7
RxC (B)	A11 (11)	13	14	X	W	26	35
RxC (A)	A12 (12)	6	7	V	U	8	17
Mode DCE	A13 (13)		8		B		19
Mode 0	B1 (14)					19	19
DTR (B)	B2 (15)					30	29
DTR (A)	B3 (16)			H	E	12	11
DCD (B)	B4 (17)					31	31
DCD (A)	B5 (18)			F	F	13	13
DSR (B)	B6 (19)					29	30
DSR (A)	B7 (20)			E	H	11	12
TxC (B)	B8 (21)			AA	AA	23	23
TxC (A)	B9 (22)			Y	Y	5	5
Mode 1	B10 (23)						
Mode 2	B11 (24)	8	8				
TxCE (B)	B12 (25)		13	W	X	35	26
TxCE (A)	B13 (26)		6	U	V	36	8

Chapter 4 Access and configuration

This chapter describes all the access and configuration options.

4.1 Access Options

The various access options are presented below. Select the procedure to suit your needs.

There are various ways you can access your device to configure it:

- Via your LAN
- Via the serial interface
- Via an ISDN connection

4.1.1 Access via LAN

Access via one of the Ethernet interfaces of your device allows you to open the **Funkwerk Configuration Interface** in a web browser for configuration purposes and to access your device via Telnet or SSH.

4.1.1.1 HTTP/HTTPS

With a current web browser, you can use the HTML interfaces to configure your device. For this, enter the following in your web browser's address field:

- `http://192.168.0.254`

or

`https://192.168.0.254`

4.1.1.2 Telnet

Apart from configuration using a web browser, with a Telnet connection you can also access the SNMP shell and use other configuration options. These are described in [Configuration options](#) on page 105.

You do not need any additional software on your PC to set up a Telnet connection to your device: Telnet is available on all operating systems.

Proceed as follows:

Windows

- (1) Click **Run...** in the Windows Start menu.
- (2) Enter `telnet <IP address of your device>`.
- (3) Click on **OK**.
A window with the login prompt appears. You are now in the SNMP shell of your device.
- (4) Continue with [Logging in for Configuration](#) on page 104.

Unix

You can also set up a Telnet connection on UNIX and Linux without any problem:

- (1) Enter `telnet <IP address of your device>` in a terminal.
A window with the login prompt appears. You are now in the SNMP shell of your device.
- (2) Continue with [Logging in for Configuration](#) on page 104.

4.1.1.3 SSH

In addition to the unencrypted and potentially viewable Telnet session, you can also connect to your device via an SSH connection. This is encrypted, so all the remote maintenance options can be carried out securely.

The following preconditions must be met in order to connect to the device via SSH:

- The encryption keys needed for the process must be available on the device.
- An SSH client must be installed on your PC.

Encryption keys

First of all, make sure that the keys for encrypting the connection are available on your device:

- (1) Log in to one of the types already available on your device (e.g. via Telnet - for login see [Logging in](#) on page 103).
- (2) Enter `update -i` for the input prompt. You are now in the Flash Management shell.
- (3) Call up a list of all the files saved on the device: `ls -al`.

If you see a display like the one below, the keys needed are already there and you can connect to the device via SSH:

```
Flash-Sh > ls -al
```

```
Flags Version Length Date Name ...
```

```
Vr-xpbc-B 7.1.04 2994754 2004/09/02 14:11:48 box150_srel.ppc860
Vrw-pl--f 0.0 350 2004/09/07 10:44:14 sshd_host_rsa_key.pub
Vrw-pl--f 0.0 1011 2004/09/07 10:44:12 sshd_host_rsa_key
Vrw-pl--f 0.0.01 730 2004/09/07 10:42:17 sshd_host_dsa_key.pub
Vrw-pl--f 0.0.01 796 2004/09/07 10:42:16 sshd_host_dsa_key
Flash-Sh >
```



Note

The device generates a key pair for each of the algorithms (RSA and DSA), i.e. two files must be stored in the flash for each algorithm (see example at above).

If no keys are available, you have to generate these first. Proceed as follows:

- (1) Leave the Flash Management shell with `exit`.
- (2) Call the **Funkwerk Configuration Interface** and log on to your device (see [Calling the Funkwerk Configuration Interface](#) on page 107).
- (3) Make sure that *English* is selected as the language.
- (4) Check the key status in the **System Management -> Administrative Access -> SSH** menu. If both keys are available, you will see the *Generated* value in the two **RSA key Status** and **DSA key Status** fields.
- (5) If one or both of these fields contains the value *Not Generated*, you must generate the relevant key. To have the device generate the key, click **Generate**.
The device generates the key and stores it in the FlashROM. *Generated* indicates that generation was successful.
- (6) Make sure that both keys have been successfully generated. If necessary, repeat the procedure described above.

Login via SSH

Proceed as follows to log in on your device via SSH:

If you have made sure that all the keys needed are available on the device, you have to check whether an SSH client is installed on your PC. Most UNIX and Linux distributions install a SSH client by default. Additional software, e.g. PuTTY, usually has to be installed on a Windows PC.

Proceed as follows to log in on your device via SSH:

UNIX

- (1) Enter `ssh <IP address of the device>` in a terminal.
The login prompt window appears. This is located in the SNMP shell of the device.
- (2) Continue with *Logging in* on page 103.

Windows

- (1) How an SSH connection is set up very much depends on the software used. Consult the documentation for the program you are using.
As soon as you have connected to the device, the login prompt window will appear. You are now in the SNMP shell of your gateway.
- (2) Continue with *Logging in* on page 103.



Note

PuTTY requires certain settings for a connection to a **bintec** device. The support pages of <http://www.funkwerk-ec.com> include FAQs, which list the required settings.

4.1.2 Access via the Serial Interface

Each **bintec** gateway has a serial interface, with which a PC can be connected directly. The following chapter describes what you have to remember when setting up a serial connection and what you can do to configure your device in this way.

Access via the serial interface is ideal if you are setting up an initial configuration of your device and a LAN access is not possible via the pre-configured IP address (192.168.0.254/255.255.255.0).

Windows

If you are using a Windows PC, you need a terminal program for the serial connection, e.g. HyperTerminal. Make sure that HyperTerminal was also installed on the PC with the Windows installation. However, you can also use any other terminal program that can be set to the corresponding parameters (see below).

If you have accessed and installed the **BRICKware** at www.funkwerk-ec.com, two links are provided in the Windows Start menu. If you use these, you do not have to make any other settings for the serial connection to your device.

Proceed as follows to access your device via the serial interface:

- (1) In the Windows Start menu, click on **Programs -> BRICKware -> Device on COM1** (or **Device on COM2**, if you use the COM2 port of your PC) to start HyperTerminal.

- (2) Press **Return** (at least once) after the HyperTerminal window opens.

A window with the login prompt appears. You are now in the SNMP shell of your device. You can now log in on your device and start the configuration.

Check

If the login prompt does not appear after you press **Return** several times, the connection to your device has not been set up successfully.

Therefore, check the COM1 or COM2 settings on your PC.

- (1) Click on **File ->Properties**.
- (2) Click **Configure** in the **Connect to** tab.
The following settings are necessary:
 - Bits per second: *9600*
 - Data bits: *8*
 - Parity: *None*
 - Stopbits: *1*
 - Flow control: *None*
- (3) Enter the values and click **OK**.
- (4) Make the following settings in the **Settings** tab:
 - Emulation: *VT100*
- (5) Click on **OK**.

The changes to the terminal program settings do not take effect until you disconnect the connection to your device and then make the connection again.

If you use HyperTerminal, there may be problems with displaying umlauts and other special characters. If necessary, therefore, set HyperTerminal to *Autodetection* instead of *VT100*.

Unix

You will require a terminal program such as `cu` (on System V), `tip` (on BSD) or `minicom` (on Linux). The settings for these programs correspond to those listed above.

Example of a command line for using `cu`: `cu -s 9600 -c/dev/ttyS1`

Example of a command line for using `tip`: `tip -9600 /dev/ttyS1`

4.1.3 Access over ISDN

All devices that have an ISDN interface can be accessed and configured from another device via an ISDN call.

Access over ISDN with ISDN Login is especially recommended if your device is to be remotely configured or maintained. This is also possible even if your device is still in the ex works state. Access is then obtained with the aid of a device that is already configured or a PC with an ISDN card in the remote LAN. The device to be configured in your own LAN is reached via a number of the ISDN connection (e.g. 1234). This enables the administrator in the Remote LAN to configure your device remotely, for example.



Note

If you connect an unconfigured device to an ISDN connection in parallel to a PBX, the PBX cannot take any calls until an ISDN number is configured on the device.

Access over ISDN costs money. If your device and your computer are in the LAN, it is cheaper to access your device via the LAN or via the serial interface.

Your device in your LAN merely needs to be connected to the ISDN connection and switched on.

To reach your device over ISDN Login, proceed as follows:

- (1) Connect your device to the ISDN.
- (2) Log in as administrator on your device in the remote LAN in the usual way.
- (3) In the SNMP shell, type in `isdnlogin <number of the ISDN connection of your device>`, e.g. `isdnlogin 1234`.
- (4) The login prompt appears. You are now in the SNMP shell of your device.

Continue with [Logging in for Configuration](#) on page 104.

4.2 Logging in

With certain access data, you can log in on your device and carry out different actions. The extent of the actions available depend on the authorisations of the user concerned.

A login prompt appears first, regardless of how you access your device. You cannot view any information on the device or change the configuration without authentication.

4.2.1 User names and passwords in ex works state

In its ex works state, your device is provided with the following user names and passwords:

User names and passwords in ex works state

User name	Password	Authorisations
admin	funkwerk	Read and change system variables, store configurations; use Funkwerk Configuration Interface .
write	public	Read and write system variables (except passwords) (changes are lost when you switch off your device).
read	public	Read system variables (except passwords).

It is only possible to change and save configurations if you log in with the user name `admin`. Access information (user names and passwords) can also only be changed if you log in with the user name `admin`. For security reasons, passwords are normally shown not in plain text but only as asterisks. The user names, on the other hand, are displayed as plain text.

The security concept of your device enables you to read all the other configuration settings with the user name `read`, but not the access information. It is therefore impossible to log in with `read`, read the password of the `admin` user and subsequently log in with `admin` and make changes to the configuration.



Caution

All **bintec** devices are delivered with the same username and password. As long as the password remains unchanged, they are therefore not protected against unauthorized use. How to change the passwords is described in [Passwords](#) on page 128.

Make sure you change the passwords to prevent unauthorized access to your device!

If you have forgotten your password, you must reset your device to the ex works state, which means your configuration will be lost.

4.2.2 Logging in for Configuration

Set up a connection to the device. The access options are described in [Access Options](#) on page 98.

Funkwerk Configuration Interface

Log in via the HTML surface as follows:

- (1) Enter your user name in the **User** field of the input window.
- (2) Enter your password in the **Password** field of the input window and confirm with **Return** or click the **Login** button.

The status page of the **Funkwerk Configuration Interface** opens in the browser.

SNMP shell

Log into the SNMP shell as follows:

- (1) Enter your user name e.g. `admin`, and confirm with **Return**.
- (2) Enter your user password e.g. `funkwerk`, and confirm with **Return**.

Your device logs in with the input prompt, e.g. `TR200bw: >`. The login was successful. You are now in the SNMP shell.

To leave the SNMP shell after completing the configuration, enter `exit` and press **Return**.

4.3 Configuration options

This chapter first offers an overview of the various tools you can use for configuration of your device.

You can configure your device in the following ways:

- **Funkwerk Configuration Interface**
- Setup Tool for experts
- SNMP shell commands

The configuration options available to you depend on the type of connection to your device:

Types of connections and configurations

Type of connection	Possible types of configuration
LAN	Funkwerk Configuration Interface , shell commands
Serial connection	Shell command

Therefore, several types of configuration are available for each type of connection.



Note

To change the device configuration, you must log in with the user name `admin`. If you do not know the password, you cannot make any configuration settings. This applies to all types of configuration.

4.3.1 Funkwerk Configuration Interface

The **Funkwerk Configuration Interface** is a web-based graphic user surface that you can use from any PC with an up-to-date web browser via an HTTP or HTTPS connection.

You can use the **Funkwerk Configuration Interface** to carry out all configuration tasks easily. It is integrated in your device and is available in English. If required, other languages can be downloaded from the download area *Software & Configuration* on page 468 of www.funkwerk-ec.com and installed on your device. To do this, proceed as described in .

The settings you make with the **Funkwerk Configuration Interface** are applied with the **OK** or **Apply** button of the menu, and you do not have to restart the device.

If you finish the configuration and want to save your settings so that they are loaded as the boot configuration when you reboot your device, save these by clicking the **Save configuration** button.

You can also use the **Funkwerk Configuration Interface** to monitor the most important function parameters of your device.

The screenshot displays the Funkwerk R1200 configuration interface. At the top, there is a navigation bar with 'Language English', 'Online Help', 'Logout', and the Funkwerk logo. A 'Save configuration' button is visible in the top left. The main content area is divided into several sections:

- Warning:** System Password not changed!
- System Information:**
 - Uptime: 8 Day(s) 22 Hour(s) 53 Minute(s)
 - System Date: Wed Feb 02 23:17:33 2005
 - Serial Number: R1E180006500018
 - BOSS Version: V.7.8 Rev. 2 (Beta 5) IPsec from 2008/11/27 00:00:00
- Resource Information:**
 - CPU Usage: 0%
 - Memory Usage: 21.5/31.9 MB (67%)
 - ISDN Usage External: 0 / 4B Channels
 - Active Sessions (SIF, RTP, etc...): 0
 - Active IPsec Tunnels: 0 / 0
- Physical Interface Table:**

Physical Interface	Interface Specifics	Link
en1-0	10.0.0.194 / 255.255.255.0	+
en1-4	Not configured / Not configured	-
WLAN1	Access Point / Channel 1 / 0 Clients / FW: 2.17.4.0.i.9d8f2.17.2.0.i.1	+
com0-8	Not configured	-
bri2-0	Not configured	-
bri2-1	Not configured	-
com6-0	Configured	-
- Recent System Logs:**

Time	Level	Subsystem	Message
04:34:43	Information	INET	sshd: pid 68 - listening on 0.0.0.0 port 22.
04:31:37	Information	INET	Connection closed by 10.0.0.254
04:31:37	Information	INET	sshd: pid 65 - listening on 0.0.0.0 port 22.
00:39:56	Information	INET	APDISCD: 2 access points found on interface 1000
00:39:46	Information	INET	APDISCD: discovery initiated on interface 1000
00:23:50	Error	TTY	UMTS Ctl umtsctl_open(): can't open umts device!
00:23:49	Information	IPSec	BinTec ipsecd version 3.0 Copyright (c) 1996-2008 by Funkwerk Enterprise Communications GmbH
00:23:49	Information	IPSec	init: running
00:23:49	Error	TTY	Modem answer to <AT+CPIN?> is 'SIM busy'
00:23:49	Information	INET	sshd: pid 56 - listening on 0.0.0.0 port 22.

Fig. 55: Funkwerk Configuration Interface Initial Screen

4.3.1.1 Calling the Funkwerk Configuration Interface

- (1) Check whether the device is connected and switched on and that all the necessary cables are correctly connected (see [Connections](#) on page 10).
- (2) Check the settings of the PC from which you want to configure your device (see [Configuring a PC](#) on page 19).
- (3) Open a web browser.
- (4) Enter `http://192.168.0.254` in the address field of the web browser.
- (5) Enter `admin` in the **User** field and `funkwerk` in the **Password** field and click **LOGIN**.

You are not in the status menu of your device's **Funkwerk Configuration Interface** (see [State](#) on page 123).

4.3.1.2 Operating elements

Funkwerk Configuration Interface window

The **Funkwerk Configuration Interface** window is divided into three areas:

- The header
- The navigation bar
- The main configuration window

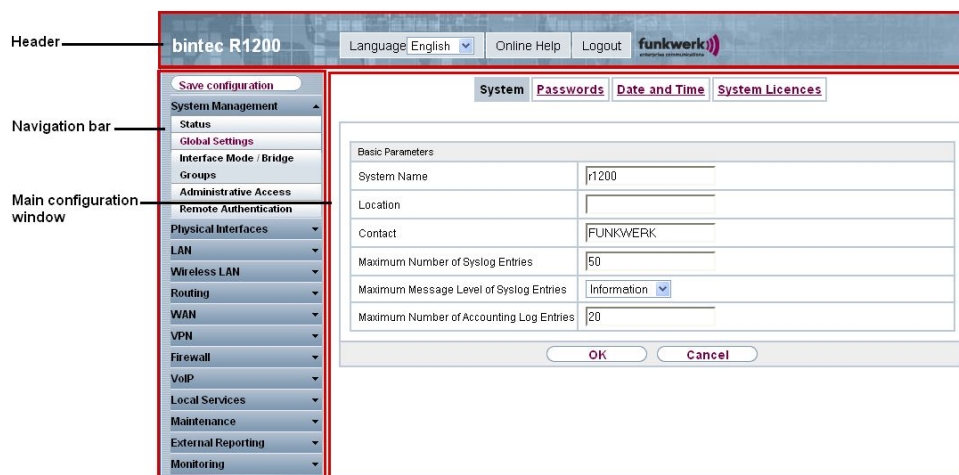

Fig. 56: Areas of the **Funkwerk Configuration Interface**

Header

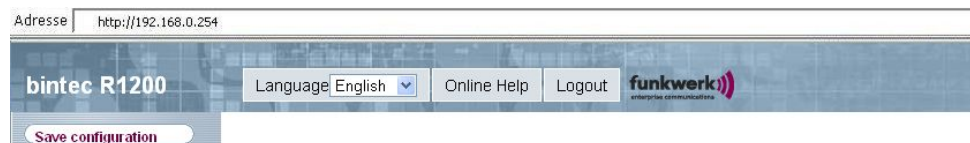
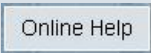
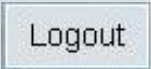

Fig. 57: **Funkwerk Configuration Interface** header

Funkwerk Configuration Interface header

Menu	Function
Language English	Language selection: From the dropdown menu, select the language in which the Funkwerk Configuration Interface is to be displayed. Here, you can select the language in which you want to carry out the configuration. German and English are avail-

Menu	Function
	able.
	Online Help: Click this button if you want help with the menu now active. The description of the sub-menu where you are now is displayed.
	Logout: If you want to end the configuration, click this button to log out of your device. A window is opened offering you the following options: <ul data-bbox="636 514 1136 628" style="list-style-type: none">• Continue with the configuration,• Save the configuration and close the window,• Exit the configuration without saving.

Navigation bar



Fig. 58: Save Configuration button

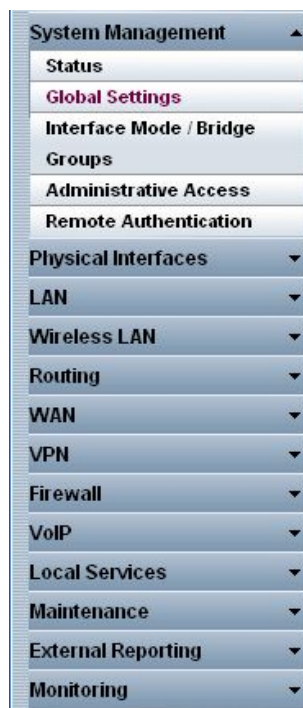

Fig. 59: Menus

The **Save Configuration** button is found in the navigation bar. Click the **Save Configuration** button to save all configuration changes, so that they are loaded as the boot configuration the next time you start the device.

The navigation bar also contains the main configuration menus and their sub-menus.

Click the main menu you require. The corresponding sub-menu then opens.

If you click the sub-menu you want, the entry selected will be displayed in red. All the other sub-menus will be closed. You can see at a glance the sub-menu you are in.

Status page

If you call the **Funkwerk Configuration Interface**, after you log in the status page of your device is displayed. The most important data of your device can be seen on this at a glance.

Main configuration window



The sub-menus generally contain several pages. These are called using the buttons at the top of the main window. If you click a button, the window is opened with the basic parameters. You can extend this by clicking the **Advanced Settings** tab, which displays the addi-

tional options.



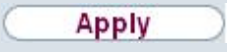
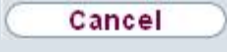
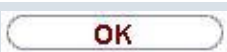
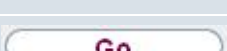

Configuration elements

The various actions that you can perform when configuring your device in the **Funkwerk Configuration** are triggered by means of the following buttons:

Funkwerk Configuration Interface buttons

















Button	Function
	Updates the view.
	If you do not want to save a newly configured list entry, cancel this and any settings made by pressing Cancel .
	Confirms the settings of a new entry and the parameter changes in a list.
	Immediately starts the configured action.
	Calls the the sub-menu to create a new entry.
	Inserts an entry in an internal list.

Funkwerk Configuration Interface buttons for special functions

Button	Function
	In the Access Point Search menu, you use this button to start automatic detection of all the access points available and connected by Ethernet in the network.
	In the VPN -> Certificates -> Certificates and the VPN -> Certificates -> CRLs menus, this button opens the sub-menus for configuring the certificates or CRL imports.
	In the VPN -> Certificates -> Certificates menu, this button opens the sub-menu for the configuration of the certificate request.
	In the Surveillance -> ISDN/Modem -> Current Calls menu, clicking on this button ends the active calls selected in the column  .

Various icons indicate the following possible actions or statuses:



Funkwerk Configuration Interface icons

Icon	Function
	Deletes the list entry.
	Displays the menu for changing the settings of an entry.
	Displays the details for an entry.
	Moves an entry. A combo box opens in which you can choose the list entry that selected entry is to be placed in front of/ after.
	Creates another list entry first and opens the configuration menu.
	Sets the status of the entry to <i>Inactive</i> .
	Sets the status of the entry to <i>Active</i> .
	Indicates "Dormant" status for an interface or connection.
	Indicates "Up" status for an interface or connection.
	Indicates "Down" status for an interface or connection.
	Indicates "Blocked" status for an interface or connection.
	Indicates "Going up" status for an interface or connection.
	Indicates that data traffic is encrypted.
	Triggers a WLAN bandscan.
	Displays the next page in a list.
	Displays the previous page in a list.

You can select the following operating functions in the list view:

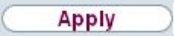
Funkwerk Configuration Interface list options

Menu	Function
Update Interval	Here you can set the interval in which the view is to be updated. To do this, enter a period in seconds in the input field and confirm it with  .
Filter	You can have the list entries filtered and displayed according to

Menu	Function
	<p>certain criteria.</p> <p>You can determine the number of entries displayed per page by entering the required number in View x per Page.</p> <p>Use the  and  buttons to scroll one page forward and one page back.</p> <p>You can filter according to certain keywords within the configuration parameters by selecting the filter rule you want under Filter in x <Option> y and entering the search word in the input field.  starts the filter operation.</p>
Configuration elements	<p>Some lists contain configuration elements.</p> <p>You can therefore change the configuration of the corresponding list entry directly in the list.</p>

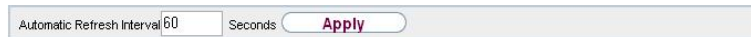

Fig. 60: Configuration of the update interval



Fig. 61: Filter list

Structure of the Funkwerk Configuration Interface configuration menus

The menus of the **Funkwerk Configuration Interface** contain the following basic structures:









Funkwerk Configuration Interface menu structure

Menu	Function
Basic configuration menu/list	<p>When you select a menu from the navigation bar, the menu of basic parameters is displayed first. In a sub-menu containing several pages, the menu containing the basic parameters is displayed on the first page.</p> <p>The menu contains either a list of all the configured entries or the basic settings for the function concerned.</p>
Sub-menu	<p>The New button is available in each menu in which a list of all the configured entries is displayed. Click the button to display the configuration menu for creating a new list entry.</p>

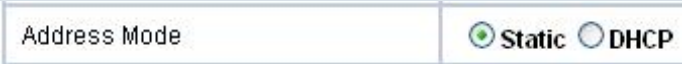
Menu	Function
Sub-menu 	Click this button to process the existing list entry. You go to the configuration menu.
Menu Advanced Settings	Click this tab to display extended configuration options.

The following options are available for the configuration:

Funkwerk Configuration Interface configuration elements

Menu	Function									
Input fields	<p>e.g. empty text field</p>  <p>Text field with hidden input</p>  <p>Enter the data.</p>									
Radio buttons	<p>e.g.</p>  <p>Select the corresponding option.</p>									
Checkboxes	<p>e.g. activation by selecting checkbox</p>  <p>Selection of several possible options</p> <table border="1"> <tbody> <tr> <td>Encryption Algorithms</td> <td><input checked="" type="checkbox"/> 3DES <input checked="" type="checkbox"/> Blowfish <input checked="" type="checkbox"/> AES-128 <input type="checkbox"/> AES-256</td> </tr> <tr> <td>Hashing Algorithms</td> <td><input checked="" type="checkbox"/> MD5 <input checked="" type="checkbox"/> SHA-1 <input checked="" type="checkbox"/> RipeMD160</td> </tr> </tbody> </table>	Encryption Algorithms	<input checked="" type="checkbox"/> 3DES <input checked="" type="checkbox"/> Blowfish <input checked="" type="checkbox"/> AES-128 <input type="checkbox"/> AES-256	Hashing Algorithms	<input checked="" type="checkbox"/> MD5 <input checked="" type="checkbox"/> SHA-1 <input checked="" type="checkbox"/> RipeMD160					
Encryption Algorithms	<input checked="" type="checkbox"/> 3DES <input checked="" type="checkbox"/> Blowfish <input checked="" type="checkbox"/> AES-128 <input type="checkbox"/> AES-256									
Hashing Algorithms	<input checked="" type="checkbox"/> MD5 <input checked="" type="checkbox"/> SHA-1 <input checked="" type="checkbox"/> RipeMD160									
Dropdown menus	<p>e.g.</p>  <p>Click the arrow to open the list. Select the required option using the mouse.</p>									
Internal lists	<p>e.g.</p> <table border="1"> <tbody> <tr> <td>Remote IP Address</td> <td>Netmask</td> <td></td> </tr> <tr> <td><input type="text"/></td> <td><input type="text" value="255.255.255.0"/></td> <td></td> </tr> <tr> <td colspan="3"><input type="button" value="Add"/></td> </tr> </tbody> </table> <p>Click <input type="button" value="Add"/>. A new list entry is created. Enter the corresponding data. If list input fields remain empty, these are not saved</p>	Remote IP Address	Netmask		<input type="text"/>	<input type="text" value="255.255.255.0"/>		<input type="button" value="Add"/>		
Remote IP Address	Netmask									
<input type="text"/>	<input type="text" value="255.255.255.0"/>									
<input type="button" value="Add"/>										

Menu	Function
	when you confirm with OK . Delete the entries by clicking the  icon.

Display of options that are not available



Options that are not available because they depend on the selection of other options are generally hidden. If the display of these options could be helpful for a configuration decision, they are instead greyed out and cannot be selected.



Important

Please look at the messages displayed in the sub-menus. These provide information on any incorrect configurations.

Warning symbols

Icon	Meaning
	This symbol appears in messages referring you to settings that were made with the Setup Tool.
	This symbol appears in messages referring you to the fact that values were entered or selected incorrectly.

Pay particular attention to the following message:

"Warning: changes not supported by the Setup Tool!". If you makes these changes with the **Funkwerk Configuration Interface**, this can cause inconsistencies or malfunctions. Therefore, it is recommended that the configuration is continued with the Setup Tool.

4.3.1.3 Funkwerk Configuration Interface menus

The configuration options of your device are contained in the sub-menus, which are displayed in the navigation bar in the left-hand part of the window.



Note

Please note that not all devices have the full range of functions. Check the software of your device on the corresponding product page under www.funkwerk-ec.com.

The **Funkwerk Configuration Interface** contains the following menus:

System management

Menu	Function
State	<p>In this menu, general information on your device is displayed at a glance.</p> <p>This information includes serial number, software version, current memory and processor use, status of the physical interfaces and the last 10 system messages.</p>
Global Settings	<p>In this menu, you enter the basic system settings of your device, such as, for example, system name, system date, system time and passwords.</p> <p>You can also manage licences that are necessary for the use of certain functions.</p>
Interface Mode / Bridge Groups	<p>In this menu, you define the mode in which the interfaces of your device are to run (routing or bridging) and if necessary can define bridge groups.</p>
Administrative Access	<p>In this menu, you configure the access options for the individual interfaces.</p>
Remote Authentication	<p>In this menu, you configure the authentication via a RADIUS server or TACAS+ server.</p>

Physical interfaces

Menu	Function
AUX	<p>You can define various settings for communication between the gateway and modem in this menu.</p>
Ethernet Ports	<p>In this menu, you configure the Ethernet interfaces of your device. To do this, you select the speed and type of interface, for example.</p>
ISDN Ports	<p>In this menu, you configure the ISDN interface of your device. Here you enter data such as the type of ISDN connection to which your device is connected.</p>
ADSL Modem	<p>Only R3000 and R3000w.</p> <p>In this menu, you configure the ADSL interface of your device. Here you specify whether Annex A or Annex B is used as ADSL</p>

Menu	Function
	mode for the broadband connection.
SHDSL	<p>Only R3400 and R3800w.</p> <p>In this menu, you configure the SHDSL interface of your device. Here you enter how many change pairs are used for the SHDSL connection.</p>
Serial ports	<p>Only R4300.</p> <p>In this menu you can configure the serial WAN interface(s) for your device, i.e. one or two integrated X.21/V.35 interfaces depending on the licence. Here you enter which clock rate is used for the connection.</p>
UMTS/HSDPA	<p>Only R1200wu.</p> <p>In this menu, you configure the CardBus interface of your device. Here you specify that UMTS is enabled.</p>

LAN

Menu	Function
IP Configuration	In this menu, you carry out the IP configuration of the LAN interfaces for your device.
VLAN	In this menu, you configure the VLANs.

Wireless LAN (only bintec R1200w, R1200wu and R3000w)

Menu	Function
WLAN1	In this menu, you configure your wireless modules as an access point or as an access client.
Administration	In this menu, you make the basic WLAN settings.

Routing

Menu	Function
Routes	In this menu, you enter additional routes.
NAT	In this menu, you configure the NAT firewall (NAT, Network Ad-

Menu	Function
	dress Translation).
RIP	In this menu, you configure the dynamic updating of the routing table via RIP.
Load Balancing	In this menu, you configure application-controlled bandwidth management.
Multicast	In this menu, you configure the use of multimedia streaming protocols for e.g. voice over IP or video and audio streaming (e.g. IPTV or Webradio) or TriplePlay (voice, video, data).

WAN

Menu	Function
Internet + Dialup	In this menu, you define the Internet connections for the various connection protocols or dialup connections.
ATM	In this menu, you carry out configuration of the ATM profiles that are needed for all the ADSL connections and also connection monitoring (OAM) and ATM QoS.
Leased line	In this menu, the permanent connections of two communication partners are displayed.
Real Time Jitter Control	In this menu, you can set the upstream speed.

VPN

Menu	Function
IPSec	In this menu, you configure VPN connections over IPSec.
L2TP	In this menu you configure the use of L2TP (Layer 2 Tunnelling Protocol).
PPTP	In this menu, you configure the an encrypted PPTP tunnel.
GRE	This menu shows a list of all configured GRE tunnels.
Certificates	In this menu you can generate and import keys and have them certified.

Firewall

Menu	Function
Policies	In this menu you configure the filter rules for the firewall.
Interfaces	In this menu, you can group together the interfaces to be filtered.
Addresses	In this menu, you can create the address aliases to be filtered.
Services	In this menu, you can create the service aliases to be filtered.

VoIP

Menu	Function
Application Level Gateway	In this menu, you configure a proxy for IP telephony, which implements the necessary NAT and firewall releases for connection to the VoIP provider.
Media Gateway	In this menu, you configure a network transition between various telecommunication networks.

Local services

Menu	Function
DNS	In this menu, you configure the name resolution.
DynDNS Client	In this menu, you configure the dynamic name resolution.
DHCP Server	In this menu, you configure your device as a DHCP server.
Web Filter	In this menu, you configure the use of the URL-based Proventia Web Filter from ISS (www.iss.net).
CAPI Server	In this menu, you configure your device as a CAPI server.
Scheduling	In this menu, you configure time-dependent standard actions of your devices.
Surveillance	In this menu, you configure the surveillance of interfaces or hosts in the network.
ISDN Theft Protection	In this menu you can configure the ISDN theft protection function for each interface.

Menu	Function
Funkwerk Discovery	In this menu, you can configure management functions for bintec Access Point.
UPnP	In this menu, you configure the UPnP settings individually for each interface of your gateway.

Maintenance

Menu	Function
Diagnostics	In this menu you can test the accessibility of hosts, DNS servers or routing.
Software & Configuration	In this menu, you can manage your device's configuration files. You can save them either locally on your device or on your computer, for example. You can also start an update of the system software.
Reboot	In this menu, you can initiate the rebooting of the device.

External Reporting

Menu	Function
Syslog	In this menu, you configure the host to which the data logged internally on the device is forwarded for saving and further processing.
IP Accounting	In this menu, you decide for which interfaces accounting messages are to be generated.
E-mail Alert	Depending on the configuration, in this menu e-mails are sent to the administrator as soon as relevant syslog messages occur.
SNMP	In this menu, you configure whether the device is to listen for external SNMP accesses and send SNMP traps.
Activity Monitor	In this menu, you configure the surveillance of your device with the Windows Tool Activity Monitor (component of BRICKware for Windows).

Monitoring menus

Menu	Function
Internal Log	In this menu, the system messages are displayed.
IPSec	In this menu, the IPSec connections and connection statistics that are currently active are displayed.
ISDN/Modem	In this menu, the ISDN connections are displayed.
Interfaces	In this menu, connection statistics and status of all interfaces are displayed.
WLAN	This menu shows you the WLAN connections statistics.

4.3.2 SNMP shell

SNMP (Simple Network Management Protocol) is a protocol that defines how you can access the configuration settings.

All configuration settings are stored in the MIB (Management Information Base) in the form of MIB tables and MIB variables. You can access these directly from the SNMP shell via SNMP commands. This type of configuration requires a detailed knowledge of our devices.

4.4 BOOTmonitor

The BOOTmonitor is only available over a serial connection to the device.

The BOOTmonitor provides the following functions, which you select by entering the corresponding number:

- (1) Boot System (reboot the system):
The device loads the compressed boot file from the flash memory to the working memory. This happens automatically on starting.
- (2) Software Update via TFTP:
The device performs a software update via a TFTP server.
- (3) Software Update via XMODEM:
The device performs a software update via a serial interface with XMODEM.
- (4) Delete configuration:
The device is reset to the ex works state. All configuration files are deleted and the BOOTmonitor settings are set to the default values.
- (5) Default BOOTmonitor Parameters:
You can change the default settings of the BOOTmonitor of the device, e.g. the

baud rate for serial connections.

(6) Show System Information:

Shows useful information about your device, e.g. serial number, MAC address and software versions.

The BOOTmonitor is started as follows.

The device passes through various functional states when starting:

- Start mode
- BOOTmonitor mode
- Normal mode

After some self-tests have been successfully carried out in the start mode, your device reaches the BOOTmonitor mode. The BOOTmonitor prompt is displayed if you are serially connected to your device.

```
Press <sp> for boot monitor or any other key to boot system
```

```
R232aw Bootmonitor V.7.2 Rev. 4 from 2005/09/06 00:00:00  
Copyright (c) 1996-2005 by Funkwerk Enterprise Communications GmbH
```

```
(1) Boot System  
(2) Software Update via TFTP  
(3) Software Update via XMODEM  
(4) Delete Configuration  
(5) Default Bootmonitor Parameters  
(6) Show System Information
```

```
Your Choice> _
```

After display of the BOOTmonitor prompt, press the space bar within four seconds to use the functions of the BOOTmonitor. If you do not make an entry within four seconds, the device changes back to normal operating mode.



Note

If you change the baud rate (the preset value is 9600 baud), make sure the terminal program used also uses this baud rate. If this is not the case, you will not be able to establish a serial connection to the device.

Chapter 5 System management

The System Management menu contains general system information and settings.

You see a system status overview. Global system parameters such as the system name, date/time, passwords and licences are managed and the access and authentication methods are configured.

5.1 State

If you log into the **Funkwerk Configuration Interface**, your device's status page is displayed, which shows the most important system information.

You see an overview of the following data:

- System status
- Your device's activities: Resource utilisation, active sessions and tunnels
- Status and basic configuration of the LAN, WAN, ISDN, WLAN, and ADSL interfaces
- Information on plugged add-on modules (if any)
- The last 10 system messages

You can customise the update interval of the status page by entering the desired period in seconds as **Automatic Update Interval** and clicking on the **Apply**-button.



Caution

Under **Automatic Refresh Interval** do not enter a value of less than 5 seconds, otherwise the refresh interval of the screen will be too short to make further changes!

bintec R1200

Language English Online Help Logout 

Save configuration

System Management

- Status
- Global Settings
- Interface Mode / Bridge Groups
- Administrative Access
- Remote Authentication
- Physical Interfaces
 - LAN
 - Wireless LAN
- Routing
 - WAN
 - VPN
- Firewall
- VoIP
- Local Services
- Maintenance
- External Reporting
- Monitoring

Automatic Refresh Interval 300 Seconds

Warning: System Password not changed!







System Information

Uptime	8 Day(s) 22 Hour(s) 53 Minute(s)
System Date	Wed Feb 02 23:17:33 2005
Serial Number	R1E180006500018
BOSS Version	V.7.8 Rev. 2 (Beta 5) IPsec from 2008/11/27 00:00:00

Resource Information

CPU Usage	0%
Memory Usage	21.5/31.9 MB (67%)
ISDN Usage External	0 / 4B Channels
Active Sessions (SIF, RTP, etc...)	0
Active IPsec Tunnels	0 / 0

Physical Interface

Physical Interface	Interface Specifics	Link
en1-0	10.0.0.194 / 255.255.255.0	
en1-4	Not configured / Not configured	
WLAN1	Access Point / Channel 1 / 0 Clients / FW: 2.17.4.0.i.9d8f2.17.2.0.i.1	
com0-8	Not configured	
bri2-0	Not configured	
bri2-1	Not configured	
com6-0	Configured	

Recent System Logs

Time	Level	Subsystem	Message
04:34:43	Information	INET	sshd: pid 68 - listening on 0.0.0.0 port 22.
04:31:37	Information	INET	Connection closed by 10.0.0.254
04:31:37	Information	INET	sshd: pid 65 - listening on 0.0.0.0 port 22.
00:39:56	Information	INET	APDISCD: 2 access points found on interface 1000
00:39:46	Information	INET	APDISCD: discovery initiated on interface 1000
00:23:50	Error	TTY	UMTS Ctl umtsctl_open(): can't open umts device!
00:23:49	Information	IPSec	BinTec ipsecd version 3.0 Copyright (c) 1996-2008 by Funkwerk Enterprise Communications GmbH
00:23:49	Information	IPSec	init: running
00:23:49	Error	TTY	Modem answer to <AT+CPIN?> is 'SIM busy'
00:23:49	Information	INET	sshd: pid 56 - listening on 0.0.0.0 port 22.

Fig. 63: System Management ->Status

The **System Management -> Status** menu consists of the following fields:

Fields in the Status System Information menu

Field	Value
Uptime	Displays the time past since the device was rebooted.
System Date	Displays the current system date and system time.
Serial Number	Displays the device serial number.
BOSS Version	Displays the currently loaded version of the system software.

Fields in the Status Resource Information menu

Field	Value
CPU Usage	Displays the CPU usage as a percentage.

Field	Value
Memory Usage	Displays the usage of the working memory in MByte in relation to the available total working memory in MByte. The usage is also displayed in brackets as a percentage.
ISDN Usage Internal	Shows the number of active B channels and the maximum number of available B channels for internal connections.
ISDN Usage External	Shows the number of active B channels and the maximum number of available B channels for external connections.
Active Sessions (SIF, RTP, etc...)	Displays the total of all SIF, TDRC, and IP load balancing sessions.
Active IPsec Tunnels	Displays the number of currently active IPsec tunnels in relation to the number of configured IPsec tunnels.

Fields in the Status Module menu

Field	Value
DSP Module	Shows the type of plugged DSP module if any.

Other fields in the Status menu

Field	Value
Physical Interface - Interface Specifics - Link	<p>The physical interfaces are listed here and their most important settings are shown. The system also displays whether the interface is connected or active.</p> <p>Interface specifics for Ethernet interfaces:</p> <ul style="list-style-type: none"> • IP Address • Netmask <p>Interface specifics for serial/ISDN interfaces:</p> <ul style="list-style-type: none"> • Configured • Not configured <p>Interface specifics for xDSL interfaces:</p> <ul style="list-style-type: none"> • Downstream/Upstream Line Speed <p>Interface Specifics for WLAN Interfaces:</p> <p>Access Point Mode:</p> <ul style="list-style-type: none"> • Operation Mode: Access Point or Off

Field	Value
	<ul style="list-style-type: none"> • The channel used on this wireless module • Number of connected clients • Number of WDS links • Software version of the wireless card <p>Access Client Mode:</p> <ul style="list-style-type: none"> • Operation Mode: Access Client or Off • The channel used on this wireless module • Software version of the wireless card <p>Bridge mode:</p> <ul style="list-style-type: none"> • Operation Mode: Bridge or Off • The channel used on this wireless module • Number of configured bridge links • Software version of the wireless card <p>Interface specifics for relay:</p> <ul style="list-style-type: none"> • Configured Mode
Recent System Logs	Displays the last 10 system messages.

5.2 Global Settings

The basic system parameters are managed in the **Global Settings** menu.

5.2.1 System

The **System Management** -> **Global Settings** -> **System** menu is used for entering the basic system data of your device.

The screenshot shows the web interface for a bintec R1200 device. The top navigation bar includes 'Language English', 'Online Help', 'Logout', and the 'funkwerk' logo. A left sidebar lists various system management options, with 'System Management' expanded to show 'Global Settings', 'Interface Mode / Bridge Groups', 'Administrative Access', and 'Remote Authentication'. The 'Global Settings' menu is further expanded to show 'System', 'Passwords', 'Date and Time', and 'System Licences'. The 'System' sub-menu is active, displaying a 'Basic Parameters' configuration form. The form contains the following fields:

Basic Parameters	
System Name	r1200
Location	
Contact	FUNKWERK
Maximum Number of Syslog Entries	50
Maximum Message Level of Syslog Entries	Information
Maximum Number of Accounting Log Entries	20

At the bottom of the form are 'OK' and 'Cancel' buttons.

Fig. 64: System Management -> Global Settings-> System

The **System Management -> Global Settings-> System** menu consists of the following fields:

Fields in the System Basic Parameters menu

Field	Value
System Name	<p>Enter the system name of your device. This is also used as the PPP host name.</p> <p>A character string of up to 255 characters is possible.</p> <p>The device type is entered as the default value.</p>
Location	<p>Enter the location of your device.</p>
Contact	<p>Enter the relevant contact person. Here you can enter the e-mail address of the system administrator, for example.</p> <p>A character string of up to 255 characters is possible.</p> <p>The default value is <i>funkwerk</i>.</p>
Maximum Number of Syslog Entries	<p>Enter the maximum number of syslog messages that are stored internally in the device.</p> <p>Possible values are 0 to 1000.</p>

Field	Value
	The default value is <i>50</i> . You can view the stored messages in Monitoring -> Internal Log .
Maximum Message Level of Syslog Entries	<p>Select the priority of system messages above which a log should be created.</p> <p>System messages are only recorded internally if they have a higher or identical priority to that indicated, i.e. all messages generated are recorded at syslog level <i>debug</i>.</p> <p>Possible values:</p> <ul style="list-style-type: none"> • <i>Emergency</i>: Only messages with emergency priority are recorded. • <i>Alert</i>: Messages with emergency and alert priority are recorded. • <i>Critical</i>: Messages with emergency, alert and critical priority are recorded. • <i>Errors</i>: Messages with emergency, alert, critical and error priority are recorded. • <i>Warning</i>: Messages with emergency, alert, critical, error and warning priority are recorded. • <i>Notice</i>: Messages with emergency, alert, critical, error, warning and notice priority are recorded. • <i>Information</i> (default value) Messages with emergency, alert, critical, error, warning, notice and information priority are recorded. • <i>Debug</i>: All messages are recorded.
Maximum Number of Accounting Log Entries	<p>Enter the maximum number of accounting entries that are stored internally in the device.</p> <p>Possible values are <i>0</i> to <i>1000</i>.</p> <p>The default value is <i>20</i>.</p>

5.2.2 Passwords

Setting the passwords is another basic system setting.

The screenshot shows the 'bintec R1200' web interface. At the top, there are links for 'Language English', 'Online Help', and 'Logout', along with the 'funkwerk' logo. A navigation menu on the left lists various system management options. The main content area has four tabs: 'System', 'Passwords', 'Date and Time', and 'System Licences'. The 'Passwords' tab is selected, displaying a form with the following sections:

- System Password**: Contains two password fields: 'System Admin Password' and 'Confirm Admin Password', both masked with dots.
- SNMP Communities**: Contains two text input fields: 'SNMP Read Community' and 'SNMP Write Community', both masked with dots.
- Global Password Options**: Contains a checkbox 'Show passwords and keys in clear text' and a 'Show' button.

At the bottom of the form are 'OK' and 'Cancel' buttons.

Fig. 65: System Management -> Global Settings-> Passwords



Note

All **bintec** devices are delivered with the same username and password. As long as the password remains unchanged, they are not protected against unauthorised use.

Make sure you change the passwords to prevent unauthorised access to the device

If the password is not changed, under **System Management-> Status** appears the warning: "System password not changed!"

The **System Management -> Global Settings -> Passwords** menu consists of the following fields:

Fields in the Passwords System Password menu

Field	Value
System Admin Password	Enter the password for the user name <code>admin</code> . This password is also used with SNMPv3 for authentication (MD5) and encryption (DES).
Confirm Admin Password	Confirm the password by entering it again.

Fields in the Passwords SNMP Communities menu

Field	Value
SNMP Read Community	Enter the password for the user name <code>read</code> .
SNMP Write Community	Enter the password for the user name <code>write</code> .

Fields in the Passwords Global Password Options menu

Field	Value
Show passwords and keys in clear text	<p>Define whether the passwords are to be displayed in clear text (plain text).</p> <p>The function is activated with <code>Show</code>.</p> <p>The function is disabled by default.</p> <p>If you activate the function, all passwords and keys in all menus are displayed and can be edited in plain text.</p> <p>The WLAN and IPSec keys are one exception here. They can only be entered in plain text. If you press OK or call the menu again, they are displayed as asterisks.</p>

5.2.3 Date and Time

You need the system time for tasks such as correct timestamps for system messages, accounting or IPSec certificates.

The screenshot displays the 'bintec R1200' web interface. At the top, there is a navigation bar with 'Language English', 'Online Help', and 'Logout' buttons, along with the 'funkwerk' logo. Below this is a secondary navigation bar with tabs for 'System', 'Passwords', 'Date and Time', and 'System Licences'. The 'Date and Time' tab is selected. On the left side, a vertical menu lists various system management options such as 'Status', 'Global Settings', 'Interface Mode / Bridge Groups', 'Administrative Access', 'Remote Authentication', 'Physical Interfaces', 'LAN', 'Wireless LAN', 'Routing', 'WAN', 'VPN', 'Firewall', 'VoIP', 'Local Services', 'Maintenance', 'External Reporting', and 'Monitoring'. The main content area is titled 'System Time' and shows the current system time as 'Thu Feb 03 02:10:48 2005'. It is divided into 'Manual Time Settings' and 'Automatic Time Settings (Time Protocol)'. The manual settings include fields for 'New Date' (Day, Month, Year) and 'New Time' (Hour, Minute). The automatic settings include a checkbox for 'Update system time from ISDN' (currently disabled), three 'Timeserver' fields (Primary, Secondary, Third) each with an 'SNTP' dropdown menu, a 'Time Offset from GMT' field set to '0 Hour(s)', a 'Time Update Interval' field set to '1440 Minute(s)', and a 'Time Update Policy' dropdown menu set to 'Normal'. At the bottom of the form are 'OK' and 'Cancel' buttons.

Fig. 66: **System Management -> Global Settings-> Date and Time**

You have the following options for determining the system time:

- You can determine the system time automatically, e.g. using ISDN or/and various time servers. To ensure that the device uses the desired current time, you should configure one or more time servers.
- You can set the system time manually on the device.



Note

If a method for automatically deriving the time is defined on the device, the values obtained in this way automatically have higher priority. A manually entered system time is therefore overwritten.

The **System Management -> Global Settings -> Date and Time** menu consists of the following fields:

Fields in the Date and Time System Time menu

Field	Description
Current System Time	The current date and current system time are displayed here. The entry cannot be changed.

Fields in the Date and Time Manual Time Settings menu

Field	Description
New Date	<p>Enter a new date.</p> <p>Format:</p> <ul style="list-style-type: none"> • Day: dd • Month: mm • Year: yyyy
New Time	<p>Enter a new time.</p> <p>Format:</p> <ul style="list-style-type: none"> • Hour: hh • Minute: mm

Fields in the Date and Time Automatic Time Settings (Time Protocol) menu

Field	Description
Update system time from ISDN	<p>Here you can activate and deactivate the ISDN function.</p> <p>The function is activated with <i>Enabled</i>.</p> <p>The function is disabled by default.</p>
Primary Timeserver	<p>Enter the first time server, by using either a domain name or an IP address.</p> <p>Also select the protocol for the time server query.</p> <p>Possible values:</p> <ul style="list-style-type: none"> • <i>SNTP</i> (default value): This server uses the simple network time protocol with UDP port 123. • <i>Time Service / UDP</i>: This server uses the Time service with UDP port 37. • <i>Time Service / TCP</i>: This server uses the Time service with TCP port 37. • <i>None</i>: This time server is not currently used for the time query.
Secondary Timeserver	Enter the second time server, by using either a domain name or

Field	Description
	<p>an IP address.</p> <p>Also select the protocol for the time server query.</p> <p>Possible values:</p> <ul style="list-style-type: none"> • <i>SNTP</i> (default value): This server uses the simple network time protocol with UDP port 123. • <i>Time Service / UDP</i>: This server uses the Time service with UDP port 37. • <i>Time Service / TCP</i>: This server uses the Time service with TCP port 37. • <i>None</i>: This time server is not currently used for the time query.
Third Timeserver	<p>Enter the third time server, by using either a domain name or an IP address.</p> <p>Also select the protocol for the time server query.</p> <p>Possible values:</p> <ul style="list-style-type: none"> • <i>SNTP</i> (default value): This server uses the simple network time protocol with UDP port 123. • <i>Time Service / UDP</i>: This server uses the Time service with UDP port 37. • <i>Time Service / TCP</i>: This server uses the Time service with TCP port 37. • <i>None</i>: This time server is not currently used for the time query.
Time Offset from GMT	<p>Select the offset in hours between the system time and the time received from the time server (usually GMT).</p> <p>Possible values are <i>-12</i> to <i>13</i>.</p> <p>The default value is <i>0</i>.</p>
Time Update Interval	<p>Enter the time interval in minutes at which the time is automatically updated.</p> <p>The default value is <i>1440</i>.</p>

Field	Description
Time Update Policy	<p>Enter the time period after which the system attempts to contact the time server again following a failed time update.</p> <p>Possible values:</p> <ul style="list-style-type: none"> • <i>Normal</i> (default value): The system attempts to contact the time server after 1, 2, 4, 8, and 16 minutes. • <i>Aggressive</i>: For ten minutes, the system attempts to contact the time server after 1, 2, 4, 8 seconds, and then every 10 seconds. • <i>Endless</i>: For an unrestricted period, the system attempts to contact the time server after 1, 2, 4, 8 seconds, and then every 10 seconds. <p>If certificates are used to encrypt data traffic in a VPN, it is extremely important that the correct time is set on the device. To ensure this is the case, for Time Update Policy, select the value <i>Endless</i>.</p>
Internal Time Server	<p>Select whether the internal time server is to be used.</p> <p>The function is activated by choosing <i>Enabled</i>. Time requests from a client will be answered with the current system time. This is given as GMT, without offset.</p> <p>The function is disabled by default. Time requests from a client are not answered.</p>

5.2.4 System Licences

This chapter describes how to activate the functions of the software licences you have purchased.

The following licence types exist:

- Licences already available in the device's ex works state
- Free extra licences
- Extra licences at additional cost

The data sheet for your device tells you which licences are available in the device's ex works state and which can also be obtained free of charge or at additional cost. You can access this data sheet at www.funkwerk-ec.com.

Entering licence data

You can obtain the licence data for extra licences via the online licensing pages in the support section at www.funkwerk-ec.com. Please follow the online licensing instructions. (Please also note the information on the licence card for licences at additional cost.) You will then receive an e-mail containing the following data:

- **License Key** and
- **Licence Serial Number**

You enter this data in the **System Management -> Global Settings-> System Licenses -> New** menu.

In the **System Management -> Global Settings ->System Licenses** menu, a list of all registered licenses is shown (**Description, License Type, License Serial Number, Status**).

Possible values for Status:

Licence	Meaning
OK	Subsystem is activated.
Not OK	Subsystem is not activated.
Not Supported	You have entered a licence for a subsystem your device does not support.

In addition, above the list is shown the **System License-ID** required for on-line licensing.

5.2.4.1 Edit/New

Choose the  icon to edit existing entries. Choose the **New** button to add licences.

The screenshot shows the web interface for a bintec R1200 device. At the top, there's a header with 'bintec R1200', a language dropdown set to 'English', 'Online Help', 'Logout', and the 'funkwerk' logo. A navigation menu on the left lists various system management options like Status, Global Settings, Interface Mode / Bridge Groups, Administrative Access, Remote Authentication, Physical Interfaces (LAN, Wireless LAN, Routing, WAN, VPN, Firewall, VoIP, Local Services, Maintenance, External Reporting, Monitoring). The main content area has tabs for 'System', 'Passwords', 'Date and Time', and 'System Licences'. The 'System Licences' tab is selected, displaying a 'Basic Parameters' section with two text input fields: 'Licence Serial Number' and 'Licence Key'. Below these fields are 'OK' and 'Cancel' buttons.

Fig. 67: **System Management -> Global Settings-> System Licences -> New**

Activating extra licences

You activate extra licences by adding the received licence information in the **System Management -> Global Settings -> System Licences -> New** menu.

The **System Management -> Global Settings -> System Licences -> New** menu consists of the following fields:

Fields in the System Licences Basic Parameters menu

Field	Value
Licence Serial Number	Enter the licence serial number you received when you bought the licence.
Licence Key	Enter the licence key you received by e-mail.



Note

If *Not OK* is displayed as the status:

- Enter the licence data again.
- Check your hardware serial number.

If *Not Supported* is displayed as the status, you have entered a license for a sub-system that your device does not support. This means you cannot use the functions of this licence.

Deactivating a licence

Proceed as follows to deactivate a licence:

- (1) Go to **System Management** -> **Global Settings**-> **System Licenses**.
- (2) Press the  icon in the line containing the licence you want to delete.
- (3) Confirm with **OK**.

The licence is deactivated. You can reactivate your additional licence at any time by entering the valid licence key and licence serial number.

5.3 Interface Mode / Bridge Groups

In this menu, you define the operating mode for your device's interfaces.

Routing versus bridging

Bridging connects networks of the same type. In contrast to routing, bridges operate at layer 2 of the OSI model (data link layer), are independent of higher-level protocols and transmit data packets using MAC addresses. Data transmission is transparent, which means the information contained in the data packets is not interpreted.

With routing, different networks are connected at layer 3 (network layer) of the OSI model and information is routed from one network to the other.

Conventions for port/interface names

The names of wireless ports in the user interface of your device are made up of the following parts:

- (a) WLAN
- (b) Number of the physical port (1 or 2)

Example: *WLAN1*

The name of the Ethernet port is made up of the following parts:

- (a) ETH, where en stands for Ethernet
- (b) Number of the port

Example: *ETH1*

The names of the interfaces connected to an Ethernet port are made up of the following parts:

- (a) Abbreviation for interface type
- (b) Number of the Ethernet port
- (c) Number of the interface

Example: *en1-0* (first interface on the first Ethernet port)

The name of the bridge group is made up of the following parts:

- (a) Abbreviation for interface type
- (b) Number of the bridge group

Example: *br0* (first bridge group)

The name of the wireless network is made up of the following parts:

- (a) Abbreviation for interface type
- (b) Number of the wireless module
- (c) Number of the interface

Example: *vss1-0* (first wireless network on the first wireless module)

The name of the WDS link or bridge link is made up of the following parts:

- (a) Abbreviation for interface type
- (b) Number of the wireless module on which the WDS link or bridge link is configured
- (c) Number of the WDS link or bridge link

Example: *wds1-0* (first WDS link or bridge link on the first wireless module)

The names of the virtual interfaces connected to an Ethernet port are made up of the following parts:

- (a) Abbreviation for interface type
- (b) Number of the Ethernet port
- (c) Number of the interface connected to the Ethernet port
- (d) Number of the virtual interface

Example: *en1-0-1* (first virtual interface based on the first interface on the first Ethernet port)

5.3.1 Interfaces

You define separately whether each interface is to operate in routing or bridging mode.

If you want to set bridging mode, you can either use existing bridge groups or create a new

bridge group.

The default setting for all existing interfaces is routing mode. On selecting the *New Bridge Group* option for **Mode / Bridge Group**, a bridge group, i.e. *br0* , *br1* etc., is automatically created and the interface is run in bridging mode.

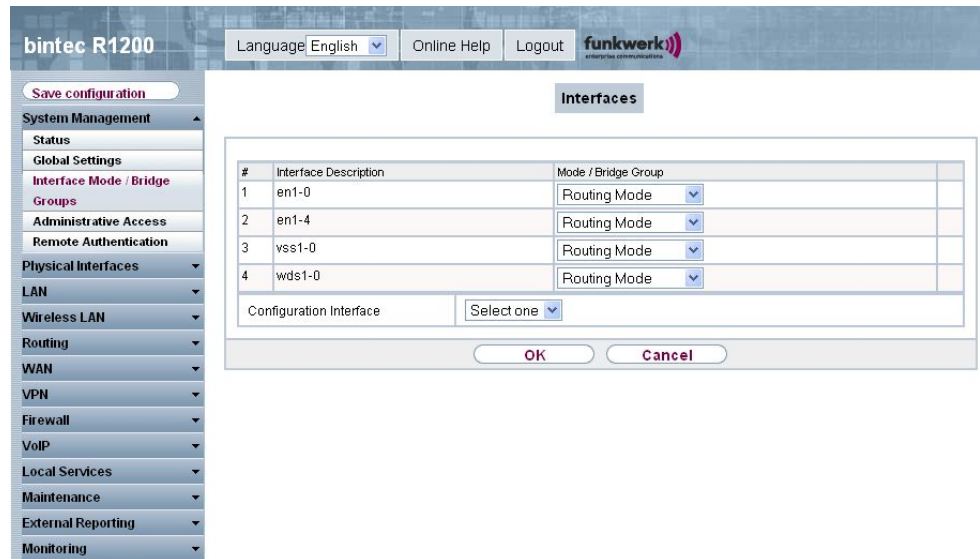

Fig. 68: System Management -> Interface Mode / Bridge Groups -> Interfaces

The **System Management -> Interface Mode / Bridge Groups -> Interfaces** menu consists of the following fields:

Fields in the Interfaces menu

Field	Description
#	The serial number of the interface is displayed here.
Interface Description	The name of the interface is displayed here.
Mode / Bridge Group	Here, you select whether you want to run the interface in <i>Routing Mode</i> or whether you want to create a new bridge group (<i>New Bridge Group</i>). If you select <i>New Bridge Group</i> , a new bridge group is created automatically when you click OK .
Configuration Interface	Select the interface via which the configuration is to be carried out. Possible values: <ul style="list-style-type: none"> <i>Select one</i> (default value): Ex works setting The right con-

Field	Description
	<p>figuration interface must be selected from the other options.</p> <ul style="list-style-type: none"> • <i>Ignore</i> : No interface is defined as configuration interface. • <i><Interface name></i>: Select the interface to be used for configuration. If this interface is in a bridge group, it is assigned the group's IP address when it is taken out of the group.

5.4 Administrative Access

In this menu, you can configure the administrative access to the device.

5.4.1 Access

In the **Administrative Access** -> **Access** menu, a list of all IP-configurable interfaces is shown.

The screenshot shows the web interface for a bintec R1200 device. The left sidebar contains a navigation menu with categories like System Management, Physical Interfaces, and Routing. The main content area is titled 'Access' and shows a table of interfaces with checkboxes for different access methods. The 'SSH' and 'SNMP' options are selected in the top right of the main area.

Interface	Telnet	SSH	HTTP	HTTPS	Ping	SNMP	ISDN Login
en1-0	<input checked="" type="checkbox"/>	<input checked="" type="checkbox"/>	<input checked="" type="checkbox"/>	<input checked="" type="checkbox"/>	<input checked="" type="checkbox"/>	<input checked="" type="checkbox"/>	<input type="checkbox"/>
en1-4	<input checked="" type="checkbox"/>	<input checked="" type="checkbox"/>	<input checked="" type="checkbox"/>	<input checked="" type="checkbox"/>	<input checked="" type="checkbox"/>	<input checked="" type="checkbox"/>	<input type="checkbox"/>
com6-0	<input type="checkbox"/>	<input type="checkbox"/>	<input type="checkbox"/>	<input type="checkbox"/>	<input type="checkbox"/>	<input type="checkbox"/>	<input checked="" type="checkbox"/>
bri2-0	<input type="checkbox"/>	<input type="checkbox"/>	<input type="checkbox"/>	<input type="checkbox"/>	<input type="checkbox"/>	<input type="checkbox"/>	<input checked="" type="checkbox"/>
bri2-1	<input type="checkbox"/>	<input type="checkbox"/>	<input type="checkbox"/>	<input type="checkbox"/>	<input type="checkbox"/>	<input type="checkbox"/>	<input checked="" type="checkbox"/>

Fig. 69: System Management -> Administrative Access-> Access

For the Ethernet interface you can select the access parameters *Telnet*, *SSH*, *HTTP*, *HT-*
TTPS

, *Ping* and *SNMP*, and for the ISDN interfaces you can select *ISDN Login*.

5.4.1.1 Add

Press the **Add** button to configure administrative access for additional interfaces.

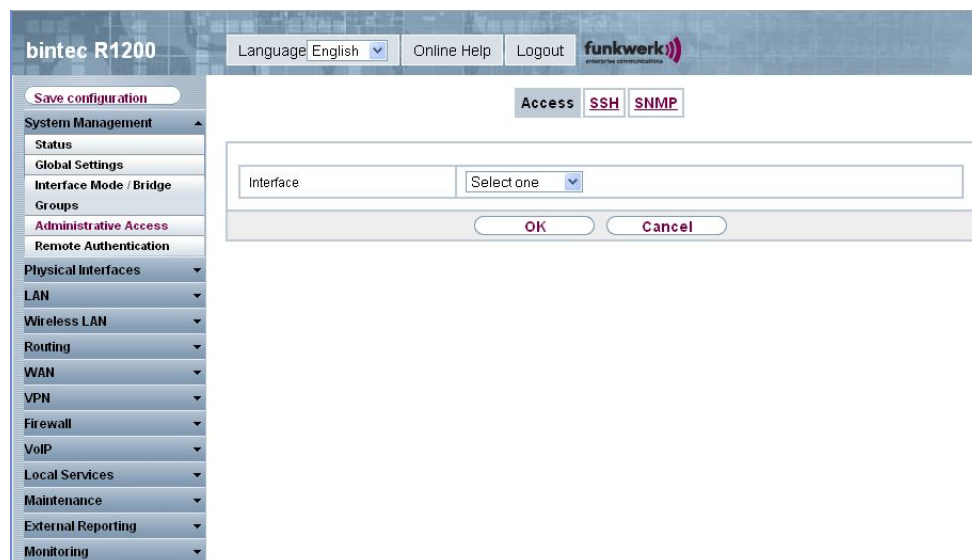

Fig. 70: **System Management -> Administrative Access -> Access -> Add**

The **System Management -> Administrative Access -> Access -> Add** menu consists of the following fields:

Fields in the Access menu

Field	Description
Interface	Select the interface for which administrative access is to be configured.

5.4.2 SSH

Your devices offers encrypted access to the shell. You can enable (**enabled**, default value) or disable this access in the **System Management -> Administrative Access -> SSH** menu and have access to the options for configuration of the SSH login.

Fig. 71: **System Management -> Administrative Access-> SSH**

You need an SSH client application, e.g. PuTTY, to be able to reach the SSH Daemon.

If you wish to use SSH Login together with the PuTTY client, you may need to comply with some special configuration requirements, for which we have prepared FAQs. You will find these in the Service/Support section at www.funkwerk-ec.com.

To be able to reach the shell of your device via an SSH client, make sure the settings for the SSH Daemon and SSH client are the same.



Note

If configuration of an SSH connection is not possible, restart the device to initialise the SSH Daemon correctly.

The **System Management -> Administrative Access-> SSH** menu consists of the following fields:

Fields in the SSH SSH Parameters (secure shell) menu

Field	Value
SSH Service Active	Select whether the SSH Daemon is to be enabled for the interface. The function is activated by choosing <i>Enabled</i> .

Field	Value
	The function is enabled by default.
Compression	Select whether data compression should be used. The function is activated by choosing <i>Enabled</i> . The function is disabled by default.
TCP Keepalives	Select whether the device is to send keepalive packets. The function is activated by choosing <i>Enabled</i> . The function is enabled by default.
Logging Level	Select the syslog level for the syslog messages generated by the SSH Daemon. Possible settings: <ul style="list-style-type: none"> • <i>Information</i> (default value) Fatal and simple errors of the SSH Daemon and information messages are recorded. • <i>Fatal</i>: Only fatal errors of the SSH Daemon are recorded. • <i>Errors</i>: Fatal and simple errors of the SSH Daemon are recorded. • <i>Debug</i>: All messages are recorded.

Fields in the SSH Authentication and Encryption Parameters menu

Field	Value
Encryption Algorithms	Select the algorithms that are to be used to encrypt the SSH connection. Possible options: <ul style="list-style-type: none"> • <i>3DES</i> • <i>Blowfish</i> • <i>AES-128</i> • <i>AES-256</i> <i>3DES</i> , <i>Blowfish</i> and <i>AES-128</i> and are enabled by default.
Hashing Algorithms	Select the algorithms that are to be available for message authentication of the SSH connection.

Field	Value
	<p>Possible options:</p> <ul style="list-style-type: none"> • <i>MD5</i> • <i>SHA-1</i> • <i>RipeMD160</i> <p><i>MD5</i>, <i>SHA-1</i> and <i>RipeMD160</i> are enabled by default.</p>

Fields in the SSH Key Status menu

Field	Value
RSA Key Status	<p>The status of the RSA key is displayed here.</p> <p>If an RSA key has not been generated yet, <i>Not Generated</i> is displayed in red and a link, <i>Generate</i>, is provided. If you select the link, the generation process is triggered and the view is updated. The status <i>Generating</i> is displayed in green. When generation has been completed successfully, the status changes from <i>Generating</i> to <i>Generated</i>. If an error occurs during generated, <i>Not Generated</i> and the <i>Generate</i> link are displayed again. You can then repeat generation.</p> <p>If the status <i>Unknown</i> is displayed, generation of a key is not possible, for example because there is not enough space in the FlashROM.</p>
DSA Key Status	<p>The status of the DSA key is displayed here.</p> <p>If a DSA key has not been generated yet, <i>Not Generated</i> is displayed in red and a link, <i>Generate</i>, is provided. If you select the link, the generation process is triggered and the view is updated. The status <i>Generating</i> is displayed in green. When generation has been completed successfully, the status changes from <i>Generating</i> to <i>Generated</i>. If an error occurs during generated, <i>Not Generated</i> and the <i>Generate</i> link are displayed again. You can then repeat generation.</p> <p>If the status <i>Unknown</i> is displayed, generation of a key is not possible, for example because there is not enough space in the FlashROM.</p>

5.4.3 SNMP

SNMP (Simple Network Management Protocol) is a network protocol used to monitor and control network elements (e.g. routers, servers, switches, printers, computers etc.) from a central station. SNMP controls communication between the monitored devices and monitoring station. The protocol describes the structure of the data packets that can be transmitted, as well as the communication process.

The data objects queried via SNMP are structured in tables and variables and defined in the MIB (Management Information Base). This contains all the configuration and status variables of the device.

SNMP can be used to perform the following network management tasks:

- Surveillance of network components
- Remote controlling and configuration of network components
- Error detection and notification

You use this menu to configure the use of SNMP.

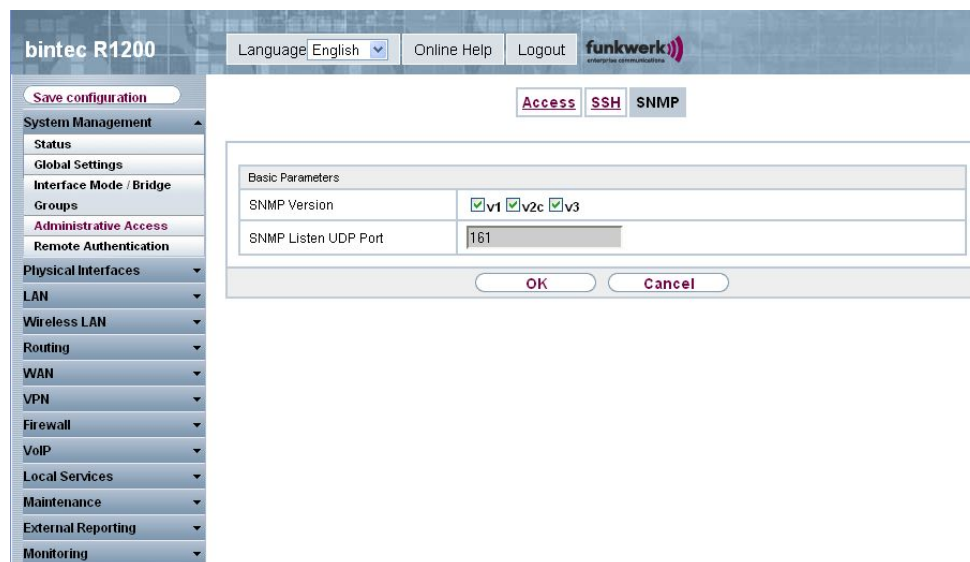

Fig. 72: System Management -> Administrative Access-> SNMP

The **Administrative Access -> Administrative Access-> SNMP** menu consists of the following fields:

Fields in the SNMP Base Parameters menu

Field	Value
SNMP Version	<p>Select the SNMP version your device is to use to listen for external SNMP accesses.</p> <p>Possible values:</p> <ul style="list-style-type: none"> • <i>v1</i>: SNMP Version 1 • <i>v2c</i>: Community-Based SNMP Version 2 • <i>v3</i>: SNMP Version 3 <p><i>v1</i>, <i>v2c</i> and <i>v3</i> are active by default.</p> <p>If no option is selected, the function is deactivated.</p>
SNMP Lists UDP Port	<p>The UDP port (<i>161</i>) at which the device receives SNMP requests is displayed here.</p> <p>The value cannot be changed.</p>



Tip

If your SNMP Manager supports SNMPv3, you should use this version is possible as older versions transmit all data unencrypted.

5.5 Remote Authentication

This menu contains the settings for user authentication.

5.5.1 RADIUS

RADIUS (Remote Authentication Dial In User Service) is a service that enables authentication and configuration information to be exchanged between your device and a RADIUS server. The RADIUS server administrates a database with information about user authentication and configuration and for statistical recording of connection data.

RADIUS can be used for:

- Authentication
- Accounting
- Exchange of configuration data

For an incoming connection, your device sends a request with user name and password to

the RADIUS server, which then searches its database. If the user is found and can be authenticated, the RADIUS server sends corresponding confirmation to your device. This confirmation also contains parameters (called RADIUS attributes), which your device uses as WAN connection parameters.

If the RADIUS server is used for accounting, your device sends an accounting message at the start of the connection and a message at the end of the connection. These start and end messages also contain statistical information about the connection (IP address, user name, throughput, costs).

RADIUS packets

The following types of packets are sent between the RADIUS server and your device (client):

Packet types

Field	Value
ACCESS_REQUEST	Client -> Server If an access request is received by your device, a request is sent to the RADIUS server if no corresponding connection partner has been found on your device.
ACCESS_ACCEPT	Server -> Client If the RADIUS server has authenticated the information contained in the ACCESS_REQUEST, it sends an ACCESS_ACCEPT to your device together with the parameters used for setting up the connection.
ACCESS_REJECT	Server -> Client If the information contained in the ACCESS_REQUEST does not correspond to the information in the user database of the RADIUS server, it sends an ACCESS_REJECT to reject the connection.
ACCOUNTING_START	Client -> Server If a RADIUS server is used for accounting, your device sends an accounting message to the RADIUS server at the start of each connection.
ACCOUNTING_STOP	Client -> Server

Field	Value
	If a RADIUS server is used for accounting, your device sends an accounting message to the RADIUS server at the end of each connection.

In the **System Management** -> **Remote Authentication** -> **RADIUS** menu, a list of all registered RADIUS servers is displayed.

5.5.1.1 Edit/New

Choose the  icon to edit existing entries. Choose the **New** button to add RADIUS servers.

The screenshot shows the configuration page for RADIUS on a bintec R1200 device. The interface includes a top navigation bar with 'Language English', 'Online Help', 'Logout', and the 'funkwerk' logo. A left sidebar contains a 'System Management' menu with options like Status, Global Settings, Interface Mode / Bridge Groups, Administrative Access, Remote Authentication, Physical Interfaces, LAN, Wireless LAN, Routing, WAN, VPN, Firewall, VoIP, Local Services, Maintenance, External Reporting, and Monitoring. The main content area has tabs for 'RADIUS', 'TACACS+', and 'Options'. The 'RADIUS' tab is active, showing two sections: 'Basic Parameters' and 'Advanced Settings'. The 'Basic Parameters' section contains: Authentication Type (dropdown: Authentication), Server IP Address (text input), RADIUS Secret (text input), Priority (dropdown: 0), and Entry active (checkbox: checked). The 'Advanced Settings' section contains: Policy (dropdown: Authoritative), UDP Port (text input: 1812), Server Timeout (text input: 1000, unit: Milliseconds), Alive Check (checkbox: checked), Retries (text input: 1), and RADIUS Dialout (checkbox: unchecked, with sub-fields: Reload Interval (text input: 0, unit: Seconds), Default User (text input), and Password (text input)). At the bottom, there are 'OK' and 'Cancel' buttons.

Fig. 73: **System Management** -> **Remote Authentication**-> **RADIUS** -> **New**

The **System Management** -> **Remote Authentication**-> **RADIUS** -> **New** menu consists of the following fields:

Fields in the RADIUS Basic Parameters menu

Field	Value
Authentication Type	<p>Select what the RADIUS server is to be used for.</p> <p>Possible values:</p> <ul style="list-style-type: none"> • <i>Authentication</i> (default value): The RADIUS server is used for controlling access to a network. • <i>PPP Accounting</i>: The RADIUS server is used for recording statistical connection data. • <i>Login Authentication</i>: The RADIUS server is used for controlling access to the SNMP shell of your device. • <i>IPSec Authentication</i>: The RADIUS server is used for sending configuration data for IPSec peers to your device. • <i>WLAN (802.1X)</i>: The RADIUS server is used for controlling access to a wireless network.
Server IP Address	Enter the IP address of the RADIUS server.
RADIUS Secret	Enter the shared password used for communication between the RADIUS server and your device.
Priority	<p>If a number of RADIUS server entries were created, the server with the highest priority is used first. If this server does not answer, the server with the next highest priority is used.</p> <p>Possible values from 0 (highest priority) to 7 (lowest priority).</p> <p>The default value is 0.</p> <p>See also Policy in the Advanced Settings.</p>
Entry active	<p>Select whether the RADIUS server configured in this entry is to be used.</p> <p>The function is activated by choosing <i>Enabled</i>.</p> <p>The function is enabled by default.</p>

The **Advanced Settings** menu consists of the following fields:

Fields in the Advanced Settings menu

Field	Value
Policy	Select how your device is to react if a negative answer to a re-

Field	Value
	<p>quest is received.</p> <p>Possible values:</p> <ul style="list-style-type: none"> • <i>Authoritative</i> (default value): A negative answer to a request is accepted. • <i>Non-authoritative</i>: A negative answer to a request is not accepted. A request is sent to the next RADIUS server until your device receives an answer from a server configured as authoritative.
UDP Port	<p>Enter the UDP port to be used for RADIUS data.</p> <p>RFC 2138 defines the default ports 1812 for authentication (1645 in older RFCs) and 1813 for accounting (4,180.84 cm older RFCs). You can obtain the port to be used from the documentation for your RADIUS server.</p> <p>The default value is <i>1812</i>.</p>
Server Timeout	<p>Enter the maximum wait time between ACCESS_REQUEST and response in milliseconds.</p> <p>After timeout, the request is repeated according to Retries or the next configured RADIUS server is requested.</p> <p>Possible values are whole numbers between <i>50</i> and <i>50000</i>.</p> <p>The default value is <i>1000</i> (1 second).</p>
Alive Check	<p>Here you can activate a check of the reachability of a RADIUS server in Status <i>Down</i>.</p> <p>An Alive Check is carried out regularly (every 20 seconds) by sending an ACCESS_REQUEST to the IP address of the RADIUS server. If the server is reachable, Status is set to <i>alive</i> again. If the RADIUS server is only reachable over a switched line (dialup connection), this can cause additional costs if the server is <i>down</i> for a long time.</p> <p>The function is activated by choosing <i>Enabled</i>.</p> <p>The function is enabled by default.</p>
Retries	Enter the number of retries for cases when there is no response

Field	Value
	<p>to a request. If an answer has still not been received after these attempts, the Status is set to <i>down</i>. If the Active Check = Enabled your device tries to reach the server every 20 seconds. If the server answers, the Status is set back to <i>alive</i>.</p> <p>Possible values are whole numbers between 0 and 10.</p> <p>The default value is 1. To prevent Status being set to <i>down</i>, set this value to 0.</p>
RADIUS Dialout	<p>Only for Authentication Type = Authentication and <i>IPSec Authentication</i>.</p> <p>Select whether your device receives requests from RADIUS server dialout routes. This enables temporary interfaces to be configured automatically and your device can initiate outgoing connections that are not configured permanently.</p> <p>The function is activated by choosing <i>Enabled</i>.</p> <p>The function is disabled by default.</p> <p>If the function is active, you can enter the following options:</p> <ul style="list-style-type: none"> • <i>Reload Interval</i> Enter the time period in seconds between the update intervals. <p>The default entry here is 0 i.e. an automatic reload is not carried out.</p> <ul style="list-style-type: none"> • <i>Default User Password</i>: This is the shared password used for communication between the RADIUS server and your device.

5.5.2 TACACS+

TACACS+ permits access control for your device, network access servers (NAS) and other network components via one or more central servers.

Like RADIUS, TACACS+ is an AAA protocol and offers authentication, authorisation and accounting services (TACACS+ Accounting is currently not supported by **bintec** devices).

The following TACACS+ functions are available on your device:

- Authentication for login shell

- Command authorisation on the shell (e.g. telnet, show)

TACACS+ uses TCP port 49 and establishes a secure and encrypted connection.

In the **System Management** -> **Remote Authentication** -> **TACACS+** menu, a list of all registered TACACS+ servers is displayed.

5.5.2.1 Edit/New

Choose the  icon to edit existing entries. Choose the **New** button to add TACACS+ servers.

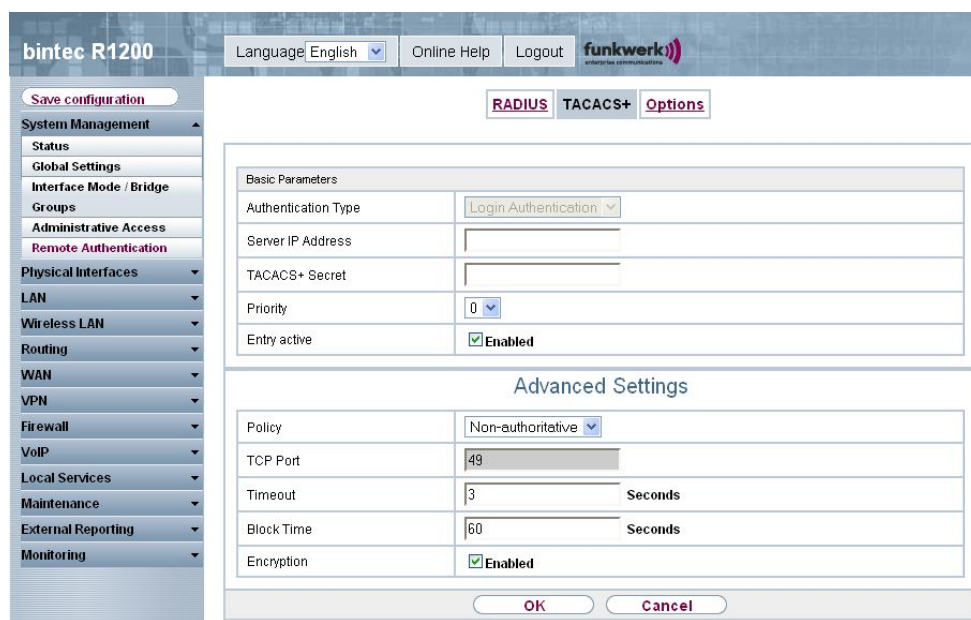

The screenshot shows the configuration interface for TACACS+ on a bintec R1200 device. The interface includes a navigation menu on the left with options like System Management, Physical Interfaces, and Monitoring. The main configuration area is titled 'TACACS+' and is divided into two sections: 'Basic Parameters' and 'Advanced Settings'. The 'Basic Parameters' section contains fields for Authentication Type (set to 'Login Authentication'), Server IP Address, TACACS+ Secret, Priority (set to '0'), and an 'Entry active' checkbox (checked). The 'Advanced Settings' section contains fields for Policy (set to 'Non-authoritative'), TCP Port (set to '49'), Timeout (set to '3' seconds), Block Time (set to '60' seconds), and an 'Encryption' checkbox (checked). At the bottom of the configuration area are 'OK' and 'Cancel' buttons.

Fig. 74: System Management -> Remote Authentication-> TACACS+ -> New

The **System Management** -> **Remote Authentication**-> **TACACS+** -> **New** menu consists of the following fields:

Fields in the TACACS+ Basic Parameters menu

Field	Description
Authentication Type	<p>This displays which TACACS+ function is to be used. The value cannot be changed.</p> <p>Possible values:</p> <ul style="list-style-type: none"> • <i>Login Authentication</i>: Here, you can define whether the

Field	Description
	current TACACS+ server is to be used for login authentication to your device.
Server IP Address	Enter the IP address of the TACACS+ server that is to be requested for login authentication.
TACACS+ Secret	Enter the password to be used to authenticate and, if applicable, encrypt data exchange between the TACACS+ server and the network access server (your device). The maximum length of the entry is 32 characters.
Priority	Assign a priority to the current TACACS+ server. The server with the lowest value is the one used first for TACACS+ login authentication. If this does not respond or access is denied (only if Policy = <i>Non-authoritative</i>), the entry with the next-highest priority is used. The available values are 0 to 9, the default value is 0.
Entry active	Select whether this server is to be used for login authentication. The function is activated by choosing <i>Enabled</i> . The function is enabled by default.

The **Advanced Settings** menu consists of the following fields:

Fields in the Advanced Settings menu

Field	Description
Policy	Select the interpretation of the TACACS+ response. Possible values: <ul style="list-style-type: none"> • <i>Non-authoritative</i> (default value): The TACACS+ servers are queried in order of their priority (see Priority) until a positive response is received or a negative response is received from an authoritative server. • <i>Authoritative</i>: A negative response to a request is accepted, i.e. a request is not sent to another TACACS+ server. The device's internal user administration is not turned off by TACACS+. It is checked after all TACACS+ servers have been queried.
TCP Port	The default TCP port (49). The value cannot be changed.

Field	Description
Timeout	<p>Enter time in seconds for which the NAS is to wait for a response from TACACS+.</p> <p>If a response is not received during the wait time, the next configured TACACS+ server is queried (only if Policy = <i>Non-authoritative</i>) and the current server is set to status <i>Blocked</i>.</p> <p>The possible values are 1 to 60, the default value is 3.</p>
Block Time	<p>Enter the time in seconds for which the current server is to remain in blocked status.</p> <p>At the end of the block time, the server is set to the status specified in the Administrative Status field.</p> <p>The possible values are 0 to 3600, the default value is 60. The value 0 means that the server is never set to <i>Blocked</i> status and thus no other servers are queried.</p>
Encryption	<p>Select whether data exchange between the TACACS+ server and the NAS is to be encrypted with MD5.</p> <p>The function is activated by choosing <i>Enabled</i>.</p> <p>The function is enabled by default.</p> <p>If the function is not enabled, the packets and all related information are transferred unencrypted. Unencrypted transfer is not recommended as a default setting and should only be used for debugging.</p>

5.5.3 Options

This setting possible here causes your device to carry out authentication negotiation for incoming calls, if it cannot identify the calling party number (e.g. because the remote terminal does not signal the calling party number). If the data (password, partner PPP ID) obtained by executing the authentication protocol is the same as the data of a listed remote terminal or RADIUS user, your device accepts the incoming call.

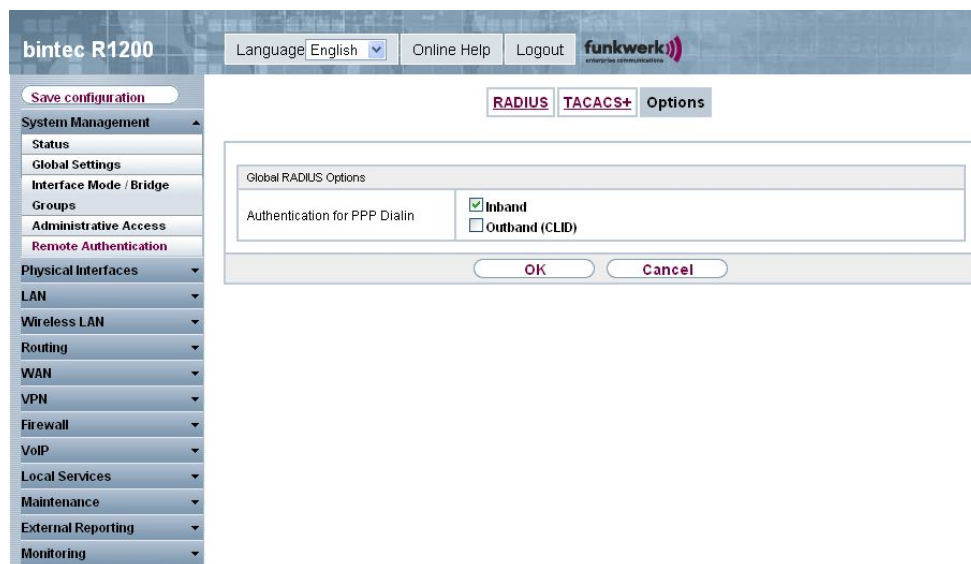

Fig. 75: **System Management -> Remote Authentication-> Options**

The **System Management -> Remote Authentication -> Options** menu consists of the following fields:

Fields in the Options Global RADIUS options menu

Field	Description
Authentication for PPP Dialin	<p>By default, the following authentication sequence is used for incoming calls with RADIUS: First CLID, then PPP and then PPP with RADIUS.</p> <p>Options:</p> <ul style="list-style-type: none"> <i>Inband</i> : Only inband RADIUS requests (PAP,CHAP, MS-CHAP V1 & V2) (i.e. PPP requests without CLID) are sent to the RADIUS server defined in Server IP Address. <i>Outband (CLID)</i> : Only outband RADIUS requests (i.e. requests for calling line identification, CLID) are sent to the RADIUS server. <p><i>Inband</i> is activated by default.</p>

Chapter 6 Physical interfaces

6.1 AUX

You require a special cable for the console port of your gateway (e.g. AUX Backup cable) to connect an external analogue modem to the AUX port on a **bintec** gateway.

6.1.1 AUX

With an analogue/GSM interface, the gateway also supports connections for analogue and GSM modems (e.g. as backup). In principle, you can use any Hayes- or GSM07.07-compatible modem with a serial interface for this purpose. The following modems have been tested successfully for **bintec**:

- US Robotics Sportster Flash (analogue modem)
- US Robotics 56K Fax Modem (analogue modem)
- Siemens TC35i (GSM modem)

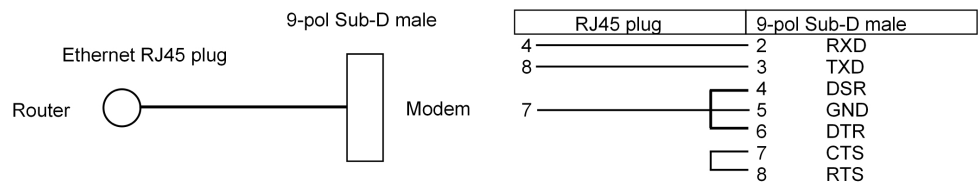

Fig. 76: PIN assignment modem cable

The screenshot shows the 'bintec R1200' web interface. The top navigation bar includes 'Language English', 'Online Help', 'Logout', and the 'funkwerk' logo. A left sidebar lists various system management options, with 'Physical Interfaces' expanded to show 'AUX'. The main content area is titled 'AUX' and contains a 'Basic Settings' form. The form fields are: 'AUX Port Status' (checked 'Enabled'), 'Line Speed' (9600 bps), 'Incoming Service Type' (radio buttons for 'Disabled', 'ISDN Login', and 'PPP Dialin'), 'SIM Card Uses PIN' (empty text field), 'Modem Escape Character' (dropdown menu), 'Modem Init Sequence' (empty text field), and 'APN (Access Point Name)' (empty text field). 'OK' and 'Cancel' buttons are located at the bottom of the form.

Fig. 77: Physical Interfaces -> AUX -> AUX

The **Physical Interfaces -> AUX -> AUX** menu consists of the following fields:

Fields in the AUX Basic Parameters menu

Field	Description
AUX Port Status	<p>Select whether the AUX port should be enabled or disabled.</p> <p>The port is enabled by choosing <i>Enabled</i>. The port is disabled by default.</p>
Line Speed	<p>Here you select the speed at which the gateway addresses the modem (in bps).</p> <p>Possible values:</p> <ul style="list-style-type: none"> • <i>Default</i>: The Baud rate of the serial terminal connection is retained. (9600 in ex works state) <p>All other values mean that the modem is addressed at the corresponding speed in bps.</p> <ul style="list-style-type: none"> • <i>9600 bps</i> • <i>19200 bps</i> • <i>38400 bps</i> • <i>57600 bps</i> (default value): Recommended for communication with a GSM modem.

Field	Description
	<ul style="list-style-type: none"> • <i>115200 bps</i>: Recommended for communication with an analogue modem.
Incoming Service Type	<p>Here you select the gateway subsystem to which an incoming call over the modem is to be assigned.</p> <p>Possible values:</p> <ul style="list-style-type: none"> • <i>Disabled</i>: No call is accepted. • <i>ISDN Login</i> (default value): The call is assigned to the ISDN Login subsystem. • <i>PPP Dialin</i>: The call is assigned to the PPP subsystem.
SIM Card Uses PIN	<p>Here you enter the PIN of your GSM modem, if your modem asks for it.</p> <p>Entering a wrong PIN blocks communication with the modem until the entry in the profile is corrected.</p>
Modem Escape Character	<p>The value for this field is set by default to <code>.</code>. It should only be changed if the escape character of the modem is different.</p>
Modem Init Sequence	<p>Here you can enter an initialization string for your modem. The command <code>ATX3&K3\V1</code> is the default setting (the modem does not wait for a free signal before dialling).</p> <p>You can add other AT commands by separating them with semicolons. The entry is limited to 50 characters. Make sure you enter the command for activating the XON/XOFF software flow control. This is proprietary and cannot be set automatically. The command sequence can be obtained from your modem manual or the manufacturer.</p>
APN (Access Point Name)	<p>If GPRS is used, the so-called Access Point Name of the provider must be entered, e.g. <code>internet.eplus.de</code> for eplus and so on.</p> <p>A maximum of 40 characters can be entered. If no APN or an incorrect APN is entered, a configured GPRS connection will not function.</p>

6.2 Ethernet Ports

An Ethernet interface is a physical interface for connection to the local network or external networks.

ETH1 - ETH4, ETH5

If the switch ports (ETH1 - ETH4) are separated from each other, each separated port is assigned the desired Ethernet interface in the **Ethernet Interface Selection** field of the **Port Configuration** menu. For each assigned Ethernet interface, another interface is displayed in the list in the **Port Configuration** menu and a completely independent configuration of the interface is possible.



Note

The Ethernet ports of the four-port switches are assigned to a single Ethernet interface in ex works state. The Ethernet interface, en1-0, is pre-configured with the **IP Address** `192.168.0.254` and **Netmask** `255.255.255.0`.

In addition, your gateway has a separate Ethernet port (ETH5), which can be used to set up a DMZ for example. This is assigned by default to Ethernet interface en1-4.

To ensure your device can be reached, when splitting ports make sure that Ethernet interface `en1-0` is assigned - with the preconfigured IP address and netmask - to a port that can be reached via Ethernet. If in doubt, carry out the configuration using a serial connection via the console interface.

VLANs for Routing Interfaces

Configure VLANs to separate individual network segments from each other, for example (e.g. individual departments of a company) or to reserve bandwidth for individual VLANs when managed switches are used with the QoS function.

6.2.1 Port Configuration

Port Separation

Your device makes it possible to run the four switch ports as one interface or to logically separate these from each other and to configure them as independent Ethernet interfaces.

By default, the same configuration applies for all switch ports.

During configuration, please note the following: The splitting of the switch ports into several Ethernet interfaces merely logically separates these from each other. The available total bandwidth of 100 mbps full duplex for all resulting interfaces remains the same. For example, if you split all the switch ports from each other, each of the resulting interfaces only uses a part of the total bandwidth. If you group together several switch ports into one interface, the full bandwidth of 100 mbps full duplex is available for all the ports together.

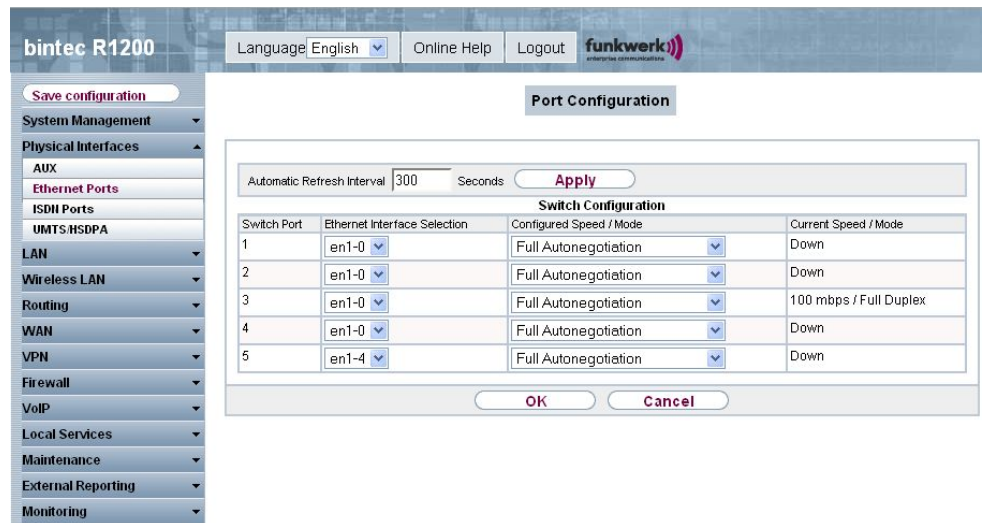

Fig. 78: Physical Interfaces -> Ethernet Ports-> Port Configuration

The **Physical Interfaces -> Ethernet Ports -> Port Configuration** menu consists of the following fields:

Fields in the Port Configuration Switch Configuration menu

Field	Description
Switch Port	Shows the respective switch port. The numbering corresponds to the numbering of the Ethernet ports on the back of the device.
Ethernet Interface Selection	Assign an Ethernet interface to the switch port. You can select from four interfaces, <i>en1-0</i> to <i>en1-3</i> . In the basic setting, interface <i>en1-0</i> is assigned to all switch ports.
Configured Speed / Mode	Select the mode in which the interface is to run.

Field	Description
	<p>Possible values:</p> <ul style="list-style-type: none"> • <i>Full Autonegotiation (default value)</i> • <i>Auto 100 mbps only</i> • <i>Auto 10 mbps only</i> • <i>Auto 100 mbps / Full Duplex</i> • <i>Auto 100 mbps / Half Duplex</i> • <i>Auto 10 mbps / Full Duplex</i> • <i>Auto 10 mbps / Half Duplex</i> • <i>Fixed 100 mbps / Full Duplex</i> • <i>Fixed 100 mbps / Half Duplex</i> • <i>Fixed 10 mbps / Full Duplex</i> • <i>Fixed 10 mbps / Half Duplex</i> • <i>Disabled</i> : The interface is created but remains inactive.
Current Speed / Mode	<p>Shows the actual mode and actual speed of the interface.</p> <p>Possible values:</p> <ul style="list-style-type: none"> • <i>100 mbps / Full Duplex</i> • <i>100 mbps / Half Duplex</i> • <i>10 mbps / Full Duplex</i> • <i>10 mbps / Half Duplex</i> • <i>Inactive</i>

6.3 ISDN Ports

In this menu, you configure the ISDN interfaces of your gateway. Here you enter data such as the type of ISDN connection to which your gateway is connected. You can use the ISDN interfaces of your gateway for various types of use.

You must carry out two steps to configure the ISDN interfaces:

- Enter the settings for your ISDN connection: Here you set the most important parameters of your ISDN connection.
- MSN Configuration: Here you tell your device how to react to incoming calls from the WAN.

6.3.1 ISDN Configuration



Note

If the ISDN protocol is not detected, it must be selected manually under **ISDN Protocol** and **ISDN Configuration Type**. The automatic D channel detection is then switched off. An incorrectly set ISDN protocol prevents ISDN connections being set up.

In the **Physical Interfaces -> ISDN Ports -> ISDN Configuration** menu a list of all ISDN ports and their configurations is shown.

6.3.1.1 Working with

Choose the  button to edit the configuration of the ISDN port.

ISDN BRI interface

You can use the ISDN BRI interface of your gateway for both dialup connections and leased lines over ISDN.

The screenshot shows the web interface for a bintec R1200 gateway. The top navigation bar includes 'Language English', 'Online Help', 'Logout', and the 'funkwerk' logo. The left sidebar menu is expanded to 'Physical Interfaces', with 'ISDN Ports' selected. The main content area is titled 'ISDN Configuration' and contains two tabs: 'ISDN Configuration' (active) and 'MSN Configuration'. The 'ISDN Configuration' tab displays a form with the following fields:

Basic Parameters	
Port Name	bri2-0 (TE)
Autoconfiguration on Bootup	<input checked="" type="checkbox"/> Enabled
Result of Autoconfiguration	Running
Port Usage	None
ISDN Configuration Type	<input checked="" type="radio"/> Point-to-Multipoint <input type="radio"/> Point-to-Point

Advanced Settings	
X.31 (X.25 in D Channel)	<input checked="" type="checkbox"/> Enabled
X.31 TEI Value	-1
X.31 TEI Service	Packet Switch

At the bottom of the form are 'OK' and 'Cancel' buttons.

Fig. 79: Physical Interfaces -> ISDN Ports-> ISDN Configuration->

The **Physical Interfaces -> ISDN Ports-> ISDN Configuration->** menu consists of the following fields:

Fields in the ISDN Configuration Basic Parameters menu

Field	Description
Port Name	Shows the name of the ISDN port.
Autoconfig on Bootup	<p>Select whether the ISDN switch type (D channel detection for switched line) is to be automatically identified.</p> <p>The function is activated with <i>Enabled</i>.</p> <p>The function is enabled by default.</p>
Result of Autoconfiguration	<p>Shows the status of the ISDN Auto Config.</p> <p>Automatic D-channel detection runs until a setting is found or until the ISDN protocol is selected manually under ISDN Protocol . This field cannot be edited.</p> <p>Possible values:</p> <ul style="list-style-type: none"> • <i>ISDN Configtype Point-to-Point</i>: See ISDN Protocol and ISDN Configuration Type • <i>ISDN Configtype Point-to-Multipoint</i>: See ISDN Protocol and ISDN Configuration Type • <i>Autoconfiguration Disabled</i>: Manual setting of ISDN Protocol and ISDN Configuration Type • <i>Running</i>: Detection is still running.
Port Usage	<p>Only if Automatic Configuration on Startup is disabled.</p> <p>Select the protocol that you want to use for the ISDN port.</p> <p>Possible values:</p> <ul style="list-style-type: none"> • <i>None</i>: The ISDN connection is not used. • <i>Euro ISDN</i>
ISDN Configuration Type	<p>Only if Automatic Configuration on Startup is disabled.</p> <p>Select the ISDN connection type.</p> <p>Possible values:</p> <ul style="list-style-type: none"> • <i>Point-to-Multipoint</i> (default value): Point-to-multipoint connection

Field	Description
	<ul style="list-style-type: none"> • <i>Point-to-point</i>: Point-to-point ISDN access
ISDN Switch Type	<p>Select the ISDN protocol supplied by your provider.</p> <p>Possible values:</p> <ul style="list-style-type: none"> • <i>Leased Line B1 64S</i>: Leased line over B channel 1 (64 kbps) • <i>Leased Line B1+B2 64S2</i>: Leased line over both B channels (128 kbps) • <i>Leased Line D+B1+B2 TS02</i>: Leased line over D-channel and both B channels (144 kbps) • <i>Leased Line B1+B2 Different Endpoints</i>: Leased line to two different endpoints. • <i>Leased Line B1+D TS01</i>: Leased line over B channel 1 and D-channel (80 kbps) • <i>Leased Line B2+D TS01</i>: Leased line over B channel 2 and D-channel (80 kbps) • <i>Leased Line B2 64S</i>: Leased line over B channel 2 (64 kbps)

The **Advanced Settings** menu consists of the following fields:

Fields in the Advanced Settings menu

Field	Description
X.31 (X.25 in D Channel)	<p>Select whether you want to use X.31 (X.25 in the D channel) e.g. for CAPI applications.</p> <p>The function is activated with <i>Enabled</i>.</p> <p>The function is disabled by default.</p>
X.31 TEI Value	<p>Only if X.31 (X.25 in D channel) is enabled</p> <p>With the ISDN autoconfiguration, the X.31-TEI is detected automatically. If the autoconfiguration has not detected TEI, you can manually enter the value assigned by the exchange.</p> <p>Possible values are 0 to 63.</p> <p>The default value is -1 (for automatic detection).</p>

Field	Description
X.31 TEI Service	<p>Only if X.31 (X.25 in D channel) is enabled</p> <p>Select the service for which you want to use X.31 TEI.</p> <p>Possible values:</p> <ul style="list-style-type: none">• <i>CAPI</i>• <i>CAPI Default</i>• <i>Packet Switch</i> (default value) <p><i>CAPI</i> and <i>CAPI Default</i> are for using X.31 TEI for CAPI applications. For <i>CAPI</i>, the TEI value set in the CAPI application is used. For <i>CAPI Default</i>, the value of the CAPI application is ignored and the default value set here is always used.</p> <p>Set <i>Packet Switch</i> if you wish to use X.31 TEI for the X.25 device.</p>

ISDN-PRI interface

For a Primary Rate Interface (PRI, or S2M), the channels are transmitted in series in so-called time slots.

Choose the  button to edit the configuration of the ISDN port.

Fig. 80: Physical Interfaces -> ISDN Ports-> ISDN Configuration->

The Physical Interfaces -> ISDN Ports-> ISDN Configuration-> menu consists of the following fields:

Fields in the ISDN Configuration Basic Parameters menu

Field	Description
Port Name	Shows the name of the ISDN port.
Port Usage	<p>Select whether the ISDN switch type (D channel detection for switched line) is to be automatically identified.</p> <p>Possible values:</p> <ul style="list-style-type: none"> <i>None</i> (default value): ISDN connection is not used. <i>EURO ISDN S2M (TE)</i>: EURO ISDN S2M User Profile <i>EURO ISDN S2M (NT)</i>: EURO ISDN S2M Network Profile <i>Back to Back (dialup)</i>: Two S2M connections are linked directly.

Field	Description
	<ul style="list-style-type: none"> • <i>Leased Line</i>: You can select a leased line.
ISDN Line Framing	<p>Only if a Port Usage is selected.</p> <p>Select the framing type for layer 1.</p> <p>Possible values:</p> <ul style="list-style-type: none"> • <i>CRC4 (Standard)</i> (default value) • <i>No CRC</i> <p>The default value can be left in the majority of scenarios. You can use the <i>No CRC</i> if required (e.g. in Sweden and France), if the device is to be connected to a PABX.</p>
Extension	<p>Only if Port Usage = <i>EURO ISDN S2m (TE)</i> or <i>EURO ISDN S2m (NT)</i> Enter the call number for the connection.</p>
Channel Selection	<p>Only if Port Usage = <i>EURO ISDN S2m (TE)</i></p> <p>To ensure compatibility with special service providers, a further option is provided for Port Usage = <i>Euro ISDN S2m (TE)</i>: If you set the switch type appropriately, you can select a value for the variable Channel Selection. This defines how the B channel is selected for an outgoing call.</p> <p>Possible values:</p> <ul style="list-style-type: none"> • <i>Any Channel</i> (default value): The device tells the PABX that all channels are available. The exchange of the PABX selects the channel to be used. • <i>No channel identification</i> : The device sends no IE (Information Element) for channel identification. The exchange selects the channel to be used. • <i>Submit preferred channel</i> : The device selects the channel to be used and signals this to the exchange. <p>You can normally use the default value. It is only necessary to change the setting in a few special cases.</p>

Field	Description
	<p>If you encounter problems with outgoing calls, ask your provider whether a special value has to be set.</p>
Clock Mode	<p>Only if Port Usage = <i>Back to Back (dialup)</i></p> <p>Defines which connection partner sends the clock signal for synchronization between the sender and the recipient. If the clock signal is not sent by the exchange itself, one of the connection partners must send the signal.</p> <p>Possible values:</p> <ul style="list-style-type: none"> • <i>External</i>: The device receives the clock signal. • <i>Internal</i>: The device sends the clock signal.
ISDN Switch Type	<p>Only if Port Usage = <i>Leased Line</i> Select the ISDN connection type.</p> <p>Possible values:</p> <ul style="list-style-type: none"> • <i>Leased Line (Custom Time Slots)</i>: Up to 31 PPP interfaces can be configured for leased lines to different destinations. • <i>Leased Line, 1 Hyperchannel (G.703 + G.704)</i>: 1984 kbps, structured • <i>Leased Line Unstructured G.703</i>: 2048 kbps, unstructured
Custom Time Slots	<p>Only if Port Usage = <i>Leased Line</i> and ISDN Switch Type = <i>Leased Line (Custom Time Slots)</i></p> <p>You have the option to bundle any channels on the physical layer as so-called hyper channels. You can also group together channels as PPP multilink channel bundles.</p> <p>Timeslots divide the available 2 Mbps bandwidth of an S2M connection into logical channels. No distinction is made below between timeslots and channels, as the difference is immaterial for configuration purposes.</p> <p>A list of the channel bundles already configured is shown.</p> <p>Click Add to configure new channel bundles.</p>

You can use the **Add** button under **Custom Time Slots** to configure further bundles.



Note

This function is only available for leased lines.

Fields in the ISDN Configuration New Bundle menu

Field	Description
Description	Enter the name of the channel bundle.
Bundle Type	<p>Displays the type of channel bundle.</p> <p>Possible values:</p> <ul style="list-style-type: none"> • <i>PPP Multilink</i>: The channels are bundled as PPP Multilink channels. • <i>Physical (Hyperchannel)</i>: The channels are bundled as physical hyperchannels.
Timeslot Selection	Choose between <i>Range Selection</i> and <i>Timeslot Matrix</i> .
Timeslot Range	<p>Only if Timeslot Selection = <i>Range Selection</i>.</p> <p>Shows the logical channels (timeslots) combined to form this channel bundle.</p> <ul style="list-style-type: none"> • <i>From</i>: Shows the first of the channels used for this channel bundle. Possible values: 1 to 31. • <i>to</i>: Shows the last of the channels used for this channel bundle. Possible values: 1 to 31. • <i>Specify Selection</i>: Here you can make a different selection.
Timeslot Matrix	Only if Timeslot Selection = <i>Timeslot Matrix</i> Shows a list of all channels in detail. If you do not wish to use all the channels between a certain start and end channel for a channel bundle, you can make a selective assignment here.
X.75 Layer 2 Mode	<p>Here you define how the interface created by this channel bundle is to behave during connection setup. You only need to configure these parameters if you used X.75 in layer 2.</p> <p>Possible values:</p>

Field	Description
	<ul style="list-style-type: none"> • <i>DCE</i> • <i>DTE</i>

6.3.2 MSN Configuration

In this menu, you can assign the available ISDN numbers to the required services (e.g. PPP routing, ISDN login).

If you use the ISDN interface for outgoing and incoming dialup connections, your own numbers for this interface can be entered in this menu (these settings are not possible for leased lines). Your device distributes the incoming calls to the internal services according to the settings in this menu. Your own number is included as the calling party number for outgoing calls.

The device supports the following services:

- **PPP (routing):** The PPP (routing) service is your device's general routing service. This enables ISDN remote terminals to establish data connections with your LAN, among other things. This enables partners outside your own local network to access hosts within your LAN. It is also possible to establish outgoing data connections to ISDN remote terminals.
- **ISDN Login:** The ISDN login service enables both incoming data connections with access to the SNMP shell of your device, and outgoing data connections to other **bintec** devices. As a result, your device can be remotely configured and administrated.
- **IPSec:** **bintec** devices support the DynDNS service to enable hosts without fixed IP addresses to obtain a secure connection over the Internet. With the IPSec Callback function and using a direct ISDN call to an IPSec peer with a dynamic IP address you can signal to this IPSec peer that you are online and waiting for the setup of an IPSec tunnel over the Internet. If the called peer currently has no connection to the Internet, the ISDN call causes a connection to be set up. The identification of the caller from his or her ISDN number is enough information to initiate setting up a tunnel.
- **X.25 PAD:** X.25 PAD is used to provide a protocol converter, which converts non-packet-oriented protocols to packet-oriented communication protocols and vice versa. Data terminal equipment sending or receiving data on a non-data-packet-oriented basis can this be adapted in line with Datex-P (public data packet network based on the principle of a packet switching exchange).

When a call comes in, your device first uses the entries in this menu to check the type of call (data or voice call) and the called party number, whereby only part of the called party number reaches the device, which is forwarded from the local exchange or, if available, the PBX. The call is then assigned to the corresponding service.



Note

If no entry is specified (ex works state), every incoming ISDN call is accepted by the ISDN Login service. To avoid this, you should make the necessary entries here. As soon as an entry exists, the incoming calls not assigned to any entry are forwarded to the CAPI service.

In the **Physical Interfaces -> ISDN Ports -> MSN Configuration** menu a list of all MSNs is shown.

6.3.2.1 New

Choose the **New** button to edit MSNs.

The screenshot shows the web interface for a bintec R1200 device. The left sidebar contains a navigation menu with categories like System Management, Physical Interfaces, LAN, Routing, WAN, VPN, Firewall, VoIP, Local Services, Maintenance, External Reporting, and Monitoring. The 'Physical Interfaces' section is expanded, showing sub-items: AUX, Ethernet Ports, ISDN Ports (highlighted), and UMTS/HSDPA. The main content area displays the 'MSN Configuration' dialog box. At the top of the dialog are tabs for 'ISDN Configuration' and 'MSN Configuration'. Below the tabs is a 'Basic Parameters' section with the following fields:

- ISDN Port: A dropdown menu currently showing 'bri2-0'.
- Service: A dropdown menu currently showing 'ISDN Login'.
- MSN: An empty text input field.
- MSN Recognition: Two radio buttons, 'Right to Left' (selected) and 'Left to Right (DDI)'.
- Bearer Service: Three radio buttons, 'Data + Voice' (selected), 'Data', and 'Voice'.

At the bottom of the dialog are 'OK' and 'Cancel' buttons.

Fig. 81: Physical Interfaces -> ISDN Ports-> MSN Configuration -> New

The **Physical Interfaces -> ISDN Ports-> MSN Configuration-> New** menu consists of the following fields:

Fields in the MSN Configuration Basic Parameters menu

Field	Description
ISDN Port	Select the ISDN port for which the MSN is to be configured.
Service	Select the service to which a call is to be assigned on the MSN below.

Field	Description
	<p>Possible values:</p> <ul style="list-style-type: none"> • <i>ISDN Login</i> (default value): Enables logging in with <i>ISDN Login</i>. • <i>PPP (Routing)</i>: Default setting for PPP routing. Contains the automatic detection of the PPP connections stated below except <i>PPP DOVB</i>. • <i>IPSec</i>: Enables a number to be defined for IPSec callback. • <i>Other (PPP)</i>: Other services can be selected: <i>PPP 64k</i> (enables 64 kbps PPP data connections), <i>PPP 56k</i> (enables 56 kbps PPP data connections), <i>PPP V.110 (9600...38400)</i> (enables PPP connections with V.110 and bit rates of 1200 bps, 2400 bps,..., 38400 bps), <i>PPP V.120</i> (enables incoming PPP connections with V.120).
MSN	<p>Enter the number used to check the called party number. For the call to be accepted, it is sufficient for the individual numbers in the entry to agree, taking account of MSN Recognition.</p>
MSN Recognition	<p>Select the mode your device is to use for the number comparison for MSN with the called party number of the incoming call.</p> <p>Possible values:</p> <ul style="list-style-type: none"> • <i>Right to Left</i> (default value) • <i>Left to Right (DDI)</i>: Always select if your device is connected to a point-to-point connection.
Bearer Service	<p>Select the type of incoming call (service detection).</p> <p>Possible values:</p> <ul style="list-style-type: none"> • <i>Data + Voice</i> (default value): Both data and voice calls. • <i>Data</i>: Data call • <i>Voice</i>: Voice call (modem, voice, analogue fax).

6.4 ADSL Modem

6.4.1 ADSL Configuration

In this menu, you make the basic settings for your ADSL connection.

R3000 and **R3000w** are ADSL multiprotocol routers with integrated ADSL(2+) modem and automatic ISDN backup. The ADSL modem on the **R3000 / R3000w** is compatible with ANNEX A and ANNEX B standards and so can be used universally in several countries. It is particularly suitable for high-speed Internet access and remote access use in SMEs or remote offices. The device is supplied ex works with 10 IPSec tunnels including hardware acceleration. Up to 100 additional IPSec tunnels can also be enabled if licensed. The integrated second ISDN S0 interface can also be enabled by licence if required.

Fig. 82: Physical Interfaces -> ADSL Modem-> ADSL Configuration

The **Physical Interfaces -> ADSL Modem-> ADSL Configuration** menu consists of the following fields:

Fields in the ADSL Configuration ADSL Port Status menu

Field	Description
ADSL chipset	Shows the key of the installed chipset.
Physical connection	Shows the current ADSL operation mode. The value cannot be changed. Possible values: <ul style="list-style-type: none"> <i>Unknown</i>: The ADSL link is not active.

Field	Description
	<ul style="list-style-type: none"> • <i>ANSI T1.413</i>: ANSI T1.413 • <i>ADSL1</i>: ADSL classic, G.DMT, ITU G.992.1 • <i>G.Lite</i>: Splitterless ADSL, ITU G.992.2 • <i>ADSL2</i>: G.DMT.Bis, ITU G.992.3 • <i>ADSL2 DELT</i>: ADSL2 Double Ended Line Test • <i>ADSL2 Plus</i>: ADSL2 Plus, ITU G.992.5 • <i>ADSL2 Plus DELT</i>: ADSL2 Plus Double Ended Line Test • <i>READSL2</i>: Reach Extended ADSL2 • <i>READSL2 DELT</i>: Reach Extended ADSL2 Double Ended Line Test • <i>ADSL2 ITU-T G.992.3 Annex M</i> • <i>ADSL2+ ITU-T G.992.5 Annex M</i>

Fields in the ADSL Configuration Current Line Speed menu

Field	Description
Downstream	Displays the data rate in the receive direction (direction from CO/DSLAM to CPE/router) in bits per second. The value cannot be changed.
Upstream	Displays the data rate in the send direction (direction from CPE/router to CO/DSLAM) in bits per second. The value cannot be changed.

Fields in the ADSL Configuration ADSL Parameters menu

Field	Description
ADSL Mode	<p>Define which Annex of ITU-T Recommendation G.991.2 is used for the connection.</p> <p>Possible values:</p> <ul style="list-style-type: none"> • <i>Annex A</i>: For applications in North America (provider-dependent) for example. • <i>Annex B</i> (default value): For applications in Europe (provider-dependent) for example.
ADSL SyncType	Select the ADSL synchronization type.

Field	Description
	<p>Possible values:</p> <ul style="list-style-type: none"> • <i>Automatic Mode</i> (default value): The ADSL mode is automatically adapted for the remote terminal. • <i>ADSL1</i>: ADSL1 / G.DMT is used. • <i>ADSL2</i>: ADSL2 / G.992.3 is used. • <i>ADSL2 Plus</i>: ADSL2 Plus / G.992.5 is used. • <i>Automatic Mode (Annex-M)</i>: Only for ADSL Mode = Annex A. The ADSL mode is automatically adapted to the other end with reference to G.992.3 Annex M. • <i>ADSL2 Plus (Annex-M)</i>: Only for ADSL Mode = Annex A. ADSL2 Plus / G.992.3 Annex M is used. • <i>None</i>: The ADSL interface is not active.
Transmit Shaping	<p>Select whether the data rate in the send direction is to be reduced. This is only needed in a few cases for special DSLAMs.</p> <p>Possible values:</p> <ul style="list-style-type: none"> • <i>Default (Line Speed)</i>: The data rate in the send direction is not reduced. • <i>128,000 bps to 2,048,000 bps</i>: The data rate in the send direction is reduced to a maximum of 128,000 bps to 2,048,000 bps in defined steps. • <i>User Defined</i>: The data rate is reduced to the value entered in Maximum Upstream Bandwidth <p>The default value is <i>Default (Line Speed)</i>.</p>
Maximum upstream bandwidth	<p>Only if Transmit Shaping = User defined</p> <p>Enter the maximum data rate in the send direction in bits per second.</p>

6.5 SHDSL

6.5.1 SHDSL Configuration

In the **SHDSL** menu you configure the SHDSL interface of your device.

R3400 and **R3800** have an integrated SHDSL mode. The devices support the ITU-T Recommendations G.991.2. Depending on the device type and configuration the gateway transmits the data over a pair of wires at up to 2312 kbps, over two pairs of wires at up to 4624 kbps, over three pairs of wires at up to 6936 kbps or over four pairs of wires at up to 9248 kbps.



Note

Ask your provider about any special features of your SHDSL connection.



Note

Agree the connection conditions for back-to-back connections (campus connect) with your remote terminal.

The SHDSL interfaces can be configured separately or as a bundle.

Choose the  button to edit the configuration of the SHDSL profile.

SHDSL Parameters	
ATM Interface	fcca-3-0
Device Mode	<input type="radio"/> CO (Central Office) <input checked="" type="radio"/> CPE (Customer Premises Equipment)
SHDSL Type	<input type="radio"/> Annex A <input checked="" type="radio"/> Annex B
Clock Rate	<input type="radio"/> Fixed <input checked="" type="radio"/> Adaptive
Wire Mode	2 wire
Line Speed Interval	Minimum 192 kbps
	Maximum 2312 kbps

Fig. 83: Physical Interfaces -> SHDSL-> SHDSL Configuration-> 

Fields in the SHDSL SHDSL Parameter menu

Field	Description
ATM Interface	Displays the name of the ATM interface.
Device Mode	Define the role within the connection.

Field	Description
	<p>Possible values:</p> <ul style="list-style-type: none"> • <i>CPE (Customer Premises Equipment)</i> (default value): Mode for the user page of the SHDSL connection. • <i>CO (Central Office)</i>: Mode for the provider page of the SHDSL connection. <p>Note: CPE on the one hand and CO on the other hand must always be set for each SHDSL connection.</p>
SHDSL Type	<p>Define which Annex of ITU-T Recommendation G.991.2 is used for the connection.</p> <p>Possible values:</p> <ul style="list-style-type: none"> • <i>Annex A</i>: For applications in North America (provider-dependent) for example. • <i>Annex B</i> (default value): For applications in Europe (provider-dependent) for example.
Clock Rate	<p>Define whether the clock rate should be negotiated.</p> <p>Possible values:</p> <ul style="list-style-type: none"> • <i>Fixed</i>: The clock rate is predefined. • <i>Adaptive</i> (default value): The clock rate is negotiated depending on the line quality.
Wire Mode	<p>Define the number and combination of wires (depending on the device type) used for the SHDSL connection.</p> <p>Only R3400:</p> <p>Possible values:</p> <ul style="list-style-type: none"> • <i>2 wire</i> (default value): Two wires are used with m-pair bonding for a clock rate of 192 kbps to 2312 kbps. • <i>4 wire</i>: Four wires are used with m-pair bonding for a clock rate of 384 kbps to 4624 kbps. This option supports 4-wire mode under G991.2 and Globespan Enhanced Mode. <p>Only R3800:</p> <ul style="list-style-type: none"> • <i>2 wire</i>: Two wires are used with m-pair bonding for a clock

Field	Description
	<p>rate of 192 kbps to 2312 kbps.</p> <ul style="list-style-type: none"> • <i>4 wire</i>: Four wires are used with m-pair bonding for a clock rate of 384 kbps to 4624 kbps. This option supports 4-wire mode under G991.2 and Globespan Enhanced Mode. • <i>4 wire standard</i>: Four wires are used for m-pair bonding with a clock rate of 384 kbps to 4624 kbps. This option supports 4-wire mode under G991.2 but not Globespan Enhanced Mode. • <i>4 wire IMA</i>: Four wires are used with IMA for a clock rate of 384 kbps to 4624 kbps. • <i>6 wire</i>: Six wires are used with m-pair bonding for a clock rate of 576 kbps to 6936 kbps. • <i>6 wire IMA</i>: Six wires are used with IMA for a clock rate of 576 kbps to 6936 kbps. • <i>8 wire</i>: Eight wires are used with m-pair bonding for a clock rate of 768 kbps to 9248 kbps. • <i>8 wire IMA</i>: Eight wires are used with IMA for a clock rate of 768 kbps to 9248 kbps.
Additional Wire Pairs	<p>Only for Wire Mode = <i>4 wire</i>, <i>4 wire standard</i>, <i>4 wire IMA</i>, <i>6 wire</i>, <i>6 wire IMA</i>.</p> <p>For Wire Mode = <i>4 wire</i>, <i>4 wire standard</i> or <i>4 wire IMA</i> the second pair of wires is defined here.</p> <p>For Wire Mode = <i>6 wire</i> or <i>6 wire IMA</i> the second and third pairs of wires are defined here.</p> <p>Wire pairs already used in defined connections are not available for selection. If these continue to be used for this SHDSL connection, the existing connection must first be terminated.</p>
Requested Rate	<p>Only for Clock Rate = <i>Fixed</i>.</p> <p>Select which speed should be used.</p>
Line Speed Interval	<p>Only for Clock Rate = <i>Adaptive</i>.</p> <p>Under Minimum select the minimum clock rate and under Maximum select the maximum clock rate for the connection.</p>

6.6 Serial ports

6.6.1 Serial ports

In the **Serial Ports** menu, configure the serial WAN interface of your gateway.

Your gateway offers an integrated X.21/V.35 interface.

The interface can be operated in accordance with various electrical standards (X.21, V.35, ...). The electrical standard used and the layer 1 operation mode (DTE or DCE) can be detected automatically from the plugged cable. Both of these parameters can also be set manually. You can purchase a suitable cable from your dealer.

Choose the  button to edit the configuration of the serial port.

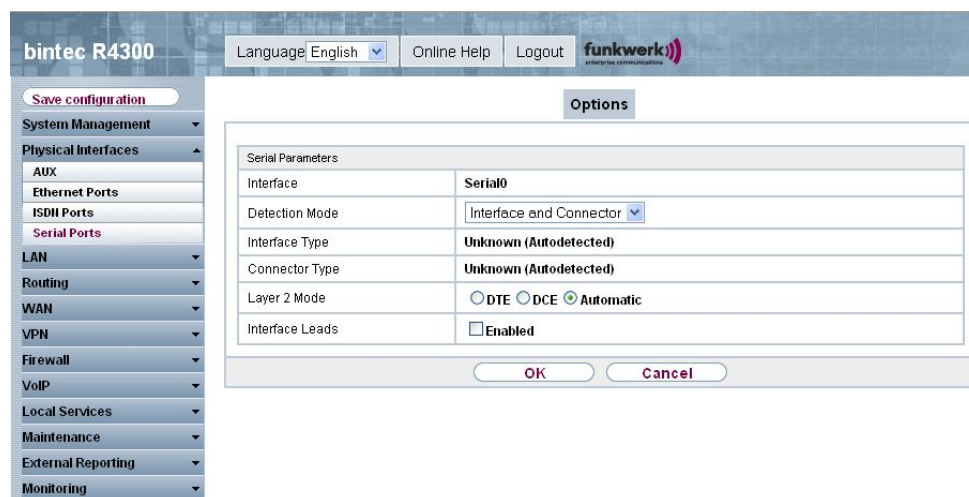



Fig. 84: Physical Interfaces -> Serial Ports-> Options-> 

The **Physical Interfaces -> Serial Ports-> Options->**  menu consists of the following fields:

Fields in the Options Serial Parameters menu

Field	Description
Interface	Displays the name of the serial interface.
Detection Mode	Define whether the interface and connector types used are to be detected automatically (autodetected) or set manually.

Field	Description
	<p>Possible values:</p> <ul style="list-style-type: none"> • <i>Interface and Connector</i> (default value): The interface and connector types are detected automatically. • <i>Interface</i>: Only the interface type is detected automatically. The connector type must be set manually. • <i>Connector</i>: Only the connector type is detected automatically. The interface type must be set manually. • <i>Manual</i>: Both the interface and connector type must be set manually.
Interface Type	<p>Define the interface type of the port used.</p> <p>If you select the Detection Mode <i>Interface and Connector</i> or <i>Interface</i>, the interface type is detected automatically. The detected value is displayed, e.g. <i>V.35 (autodetected)</i>.</p> <p>If you select the Detection Mode <i>Connector</i> or <i>Manual</i>, you must set the interface type field manually.</p> <p>Possible values:</p> <ul style="list-style-type: none"> • <i>None</i>: The port is not used. • <i>X.21 with Termination</i>: V.11 on all lines, 120-ohm terminating resistor on critical input lines. • <i>V.35</i>: V.35 on critical lines, V.28 on uncritical lines. • <i>V.36</i>: V.11 on critical lines, V.10 on uncritical lines. • <i>X.21 bis</i>: V.28 on all lines. • <i>X.21 without Termination</i>: Unterminated V.11 on all lines. • <i>RS-449</i>: V.11 on critical lines, V.10 on uncritical lines (9-pole or 37-pole sub-D plug). • <i>RS-530</i>: V.11 on critical lines, V.10 on uncritical lines (25-pole sub-D plug). • <i>RS-530a</i>: V.11 on critical lines, V.10 on uncritical lines incl. DTR and DSR (25-pole sub-D plug).
Connector Type	<p>Define the connector type of the port used.</p> <p>If you select the Detection Mode <i>Interface and Connector</i> or <i>Connector</i>, the connector type is detected automatically.</p>

Field	Description
	<p>The detected value is displayed, e.g. <i>Unknown</i> (<i>Autodetected</i>).</p> <p>If you select the Detection Mode <i>Interface</i> or <i>Manual</i>, you must set the connector type field manually.</p> <p>Possible values:</p> <ul style="list-style-type: none"> • <i>DTE</i>: The pins are assigned as DTE interface. This setting is necessary, for example, if the router is connected to a public data network like Datex-P in Germany. • <i>DCE</i>: The pins are assigned as DCE interface.
Layer 2 Mode	<p>Define the value of the HDLC address field in the transmitted command frames (Layer 2).</p> <p>Possible values:</p> <ul style="list-style-type: none"> • <i>Automatic</i> (default value): The selection made for connector is applied. You can usually accept this setting, e.g. for access to a public data network such as Datex-P. • <i>DTE</i>: The address field has the value for DTE. • <i>DCE</i>: The address field has the value for DCE.
Interface Leads	<p>Define whether the gateway checks the status of the interface lines. The same value should be set for both connection partners.</p> <p>Possible values:</p> <ul style="list-style-type: none"> • <i>Enabled</i>. The Layer 1 signalling of the remote terminal is checked on the signal line (I for X.21, CTS for V.35). The check correspondingly affects the variable L1State. • <i>Disabled</i> (default value): The Layer 1 signalling of the remote terminal is not checked, your gateway assumes that the physical line is always "up". In this setting, you should monitor the interface line in some other way, e.g. with PPP Keepalive.

6.7 UMTS / HSDPA

6.7.1 UMTS / HSDPA / HSUPA

In the UMTS / HSDPA / HSUPA menu configure the connection for a UMTS CardBus modem.

R1200wu comes with automatic ISDN backup and UMTS / HSDPA.

Fig. 85: Physical Interfaces ->UMTS / HSDPA-> UMTS / HSDPA / HSUPA

The **Physical Interfaces -> UMTS / HSDPA-> UMTS / HSDPA / HSUPA** menu consists of the following fields:

Fields in the UMTS / HSDPA / HSUPA Basic Settings menu

Field	Description
UMTS/HSDPA/HSUPA Status	Select whether or not UMTS/HSDPA/HSUPA is to be enabled on your device. The function is activated with <i>Enabled</i> . The function is disabled by default.
Network Quality	Only for UMTS/HSDPA/HSUPA Status = <i>Enabled</i> Displays the current quality of the UMTS connection. The value cannot be changed.
Incoming Service Type	Only for UMTS/HSDPA/HSUPA Status = <i>Enabled</i>

Field	Description
	<p>Here you select the gateway subsystem to which an incoming call over the modem is to be assigned.</p> <p>Possible values:</p> <ul style="list-style-type: none"> • <i>ISDN Login</i>(default value): The call is assigned to the ISDN Login subsystem. • <i>PPP Dialin</i>: The call is assigned to the PPP subsystem. • <i>Disabled</i> : No call is accepted.
SIM Card Uses PIN	<p>Only for UMTS/HSDPA/HSUPA Status = Init Sequence <i>Enabled</i></p> <p>Enter the PIN for your UMTS modem card.</p> <p>Note: Entering a wrong PIN blocks communication until the entry is corrected.</p>
Modem Init Sequence	<p>Only for UMTS/HSDPA/HSUPA Status = <i>Enabled</i></p> <p>Here you can enter an initialization string for your modem. You can add other AT commands if required by separating them with semicolons. The entry is limited to 80 characters.</p>
APN (Access Point Name)	<p>Only for UMTS/HSDPA/HSUPA Status = <i>Enabled</i></p> <p>If GPRS/UMTS is to be used, you must enter the so-called Access Point Name here that you receive from your provider. A maximum of 80 characters can be entered.</p> <p>If no APN or an incorrect APN is entered, a configured GPRS/UMTS connection will not function.</p>

Chapter 7 LAN

In this menu, you configure the addresses in your LAN and can structure your local network using VLANs.

7.1 IP Configuration

In this menu, you can edit the IP configuration of the LAN and Ethernet interfaces of your device.

7.1.1 Interfaces

In the **LAN IP Configuration Interfaces** menu, the available IP interfaces are listed. You can edit the IP configuration of the interfaces or create virtual interfaces for special applications. Interfaces are also listed here once you have created them in the subsystems (wireless networks, bridge lines, WDS links), and then set them to routing mode in the **System Management Interface Mode / Bridge Groups Interfaces** menu.

Use the  to edit the settings of an existing interface (bridge groups, Ethernet interfaces in routing mode).

You can use the **New** button to create virtual interfaces. However, this is only needed in special applications (e.g. BRRP).

Depending on the option selected, different fields and options are available. All the configuration options are listed below.

The default setting for all existing interfaces of your device is Bridging mode. The bridge group **br0** is pre-configured with the IP address `192.168.0.254` and netmask `255.255.255.0`.

Example of subnets

If your device is connected to a LAN that consists of two subnets, you should enter a second **IP / Netmask**.

The first subnet has two hosts with the IP addresses 192.168.42.1 and 192.168.42.2, for example, and the second subnet has two hosts with the IP addresses 192.168.46.1 and 192.168.46.2. To be able to exchange data packets with the first subnet, your device uses the IP address 192.168.42.3, for example, and 192.168.46.3 for the second subnet. The netmasks for both subnets must also be indicated.

7.1.1.1 Edit/New

Choose the  icon to edit existing entries. Choose the **New** button to create virtual interfaces.

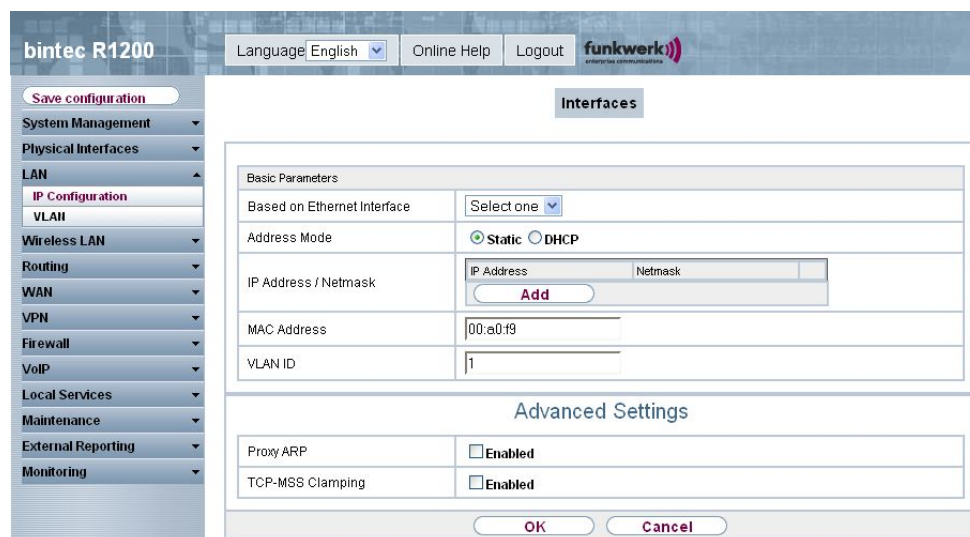

The screenshot shows the web interface for a bintec R1200 device. The left sidebar contains a navigation menu with categories like System Management, Physical Interfaces, LAN, Wireless LAN, Routing, WAN, VPN, Firewall, VoIP, Local Services, Maintenance, External Reporting, and Monitoring. The 'LAN' category is expanded, showing 'IP Configuration' and 'VLAN'. The 'IP Configuration' section is further expanded to show 'Interfaces'. The main content area is titled 'Interfaces' and contains a form for configuring a virtual interface. The form is divided into two sections: 'Basic Parameters' and 'Advanced Settings'. The 'Basic Parameters' section includes fields for 'Based on Ethernet Interface' (a dropdown menu), 'Address Mode' (radio buttons for 'Static' and 'DHCP'), 'IP Address / Netmask' (two input fields with an 'Add' button), 'MAC Address' (input field with '00:a0:f9'), and 'VLAN ID' (input field with '1'). The 'Advanced Settings' section includes 'Proxy ARP' and 'TCP-MSS Clamping', both with 'Enabled' checkboxes. At the bottom of the form are 'OK' and 'Cancel' buttons.

Fig. 86: LAN -> IP Configuration -> Interfaces -> Edit/New

The LAN -> IP Configuration -> Interfaces -> Edit/New menu consists of the following fields:

Fields in the Interfaces Basic Parameters menu

Field	Description
Based on Ethernet Interface	This field is only displayed if you are editing a virtual routing interface. Select the Ethernet interface for which the virtual interface is to be configured.
Address Mode	Select how an IP address is assigned to the interface. Possible values: <ul style="list-style-type: none"> <i>Static</i> (default value): A static IP address is assigned to the interface in IP Address/Netmask. <i>DHCP</i>: An IP address is assigned to the interface dynamically via DHCP.

Field	Description
IP Address/Netmask	<p>Only if Address Mode = <i>Static</i></p> <p>With Add, add a new address entry and enter the IP Address and corresponding Netmask</p>
Interface Mode	<p>Select the configuration mode of the interface.</p> <p>Possible values:</p> <ul style="list-style-type: none"> • <i>Manual</i> (default value): The interface is not assigned for a specific purpose. • <i>VLAN</i>: This option only applies for routing interfaces. <p>You use this option to assign the interface to a VLAN. This is done using the VLAN ID, which is displayed in this mode and can be configured. In this mode, the definition of a MAC address in MAC Address is optional.</p>
MAC Address	<p>Only for virtual interfaces and if Interface Mode = <i>Manual</i></p> <p>If Use built-in is enabled (default setting), the MAC address associated with the interface is used. For virtual interfaces, you can use the MAC address of the physical interface under which the virtual interface was created, but this is not necessary. You can also allocate a virtual MAC address. The first 6 characters of the MAC address are preset (but can be changed). Apply the defined MAC address.</p>
VLAN ID	<p>Only if Interface Mode = <i>VLAN</i>.</p> <p>This option only applies for routing interfaces. Assign the interface to a VLAN by entering the VLAN ID of the relevant VLAN.</p> <p>Possible values are 0 (default value) to 4094.</p>

The **Advanced Settings** menu consists of the following fields:

Fields in the Advanced Settings menu

Field	Description
DHCP MAC Address	<p>Only if Address Mode = <i>DHCP</i></p> <p>If Use Built-In is activated (default setting), the hardware MAC address of the Ethernet interface is used. In the case of physical</p>

Field	Description
	<p>interfaces, the current MAC address is entered by default.</p> <p>If you disable Use Built-In, you enter a MAC address for the virtual interface, e.g. <code>00:e1:f9:06:bf:03</code>.</p> <p>Some providers use hardware-independent MAC addresses to allocate their clients IP addresses dynamically. If your provider has assigned you a MAC address, enter this here.</p>
DHCP Hostname	<p>Only if Address Mode = <i>DHCP</i></p> <p>Enter the host name requested by the provider. The maximum length of the entry is 45 characters.</p>
Proxy ARP	<p>Select whether your device is to respond to ARP requests from its own LAN on behalf of defined remote terminals.</p> <p>The function is activated by choosing <i>Enabled</i>.</p> <p>The function is disabled by default.</p>
TCP-MSS Clamping	<p>Select whether your device is to apply MSS Clamping. To prevent IP packets fragmenting, the MSS (Maximum Segment Size) is automatically decreased by the device to the value set here.</p> <p>The function is activated by choosing <i>Enabled</i>.</p> <p>The function is disabled by default. Once enabled, the default value <code>1350</code> is entered in the input field.</p>

7.2 VLAN

By implementing VLAN segmentation in accordance with 802.1Q, you can configure VLANs on your device. The wireless ports of an access point, in particular, are able to remove the VLAN tag of a frame sent to the clients and to tag received frames with a pre-defined VLAN ID. This functionality makes an access point nothing less than a VLAN-aware switch with the enhancement of grouping clients into VLAN groups. In general, VLAN segmenting can be configured with all interfaces.

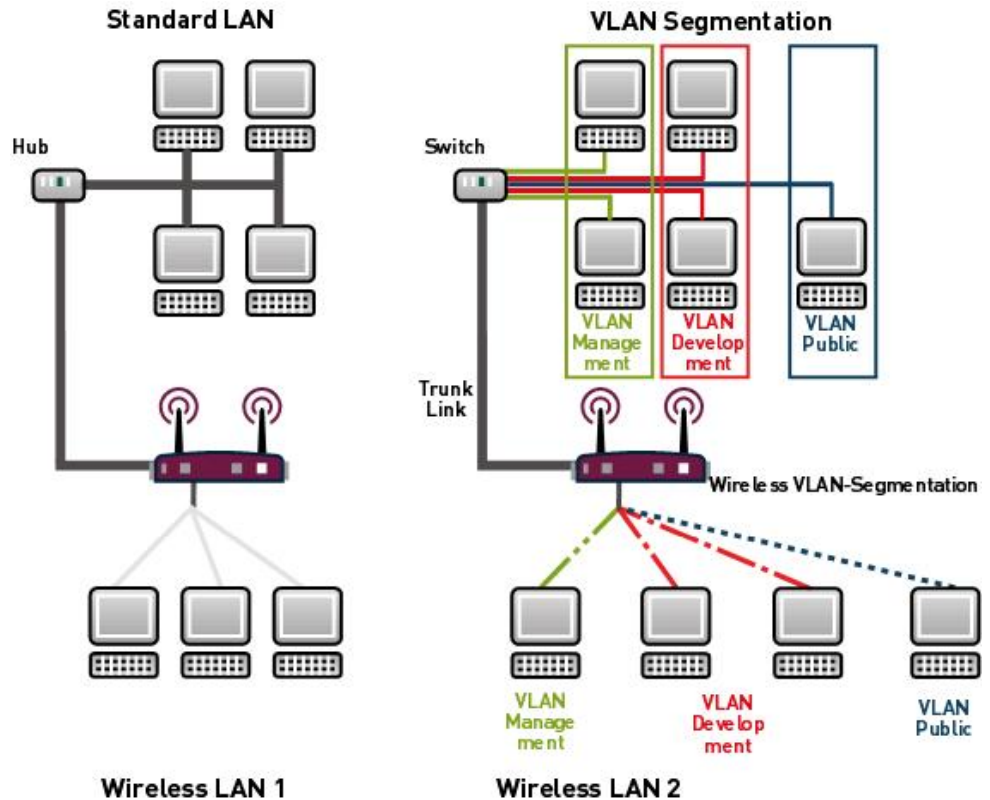

Fig. 87: VLAN segmenting

VLAN for Bridging and VLAN for Routing

In the **LAN -> VLAN** menu, VLANs (virtual LANs) are configured with interfaces that operate in bridging mode. Using the **VLAN** menu, you can make all the settings needed for this and query their status.



Caution

For interfaces that operate in Routing mode, you only assign a VLAN ID to the interface. You define this via the parameter **Interface Mode = VLAN** and the **VLAN ID** field in the **LAN -> IP Configuration -> Interfaces -> New** menu.

7.2.1 VLANs

In this menu, you can display all the VLANs already configured, edit your settings and create new VLANs. By default, the *Management* VLAN is available, to which all interfaces are assigned.

7.2.1.1 Edit/New

Choose the  icon to edit existing entries. Choose the **New** button to configure other VLANs.

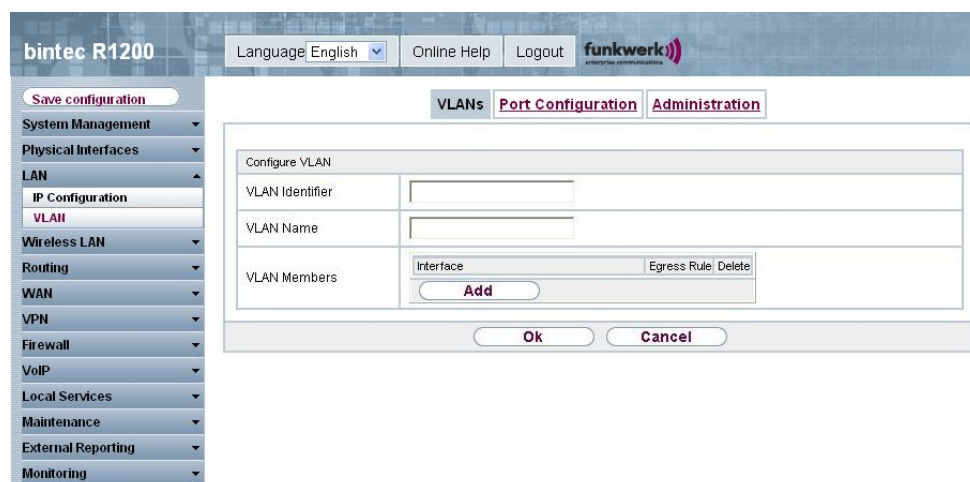

Fig. 88: LAN ->VLAN-> VLANs -> Edit/New

The LAN ->VLAN -> VLANs ->Edit/New menu consists of the following fields:

Fields in the VLANs Configure VLAN menu

Field	Description
VLAN Identifier	Enter the number that identifies the VLAN. In the Edit menu, you can no longer change this value. Possible values are 1 to 4094.
VLAN Name	Enter a unique name for the VLAN. A character string of up to 32 characters is possible.
VLAN Members	Select the ports that are to belong to this VLAN. You can use the Add button to add members.

Field	Description
	For each entry, also select whether the frames to be transmitted from this port are to be transmitted <i>tagged</i> (i.e. with VLAN information) or <i>untagged</i> (i.e. without VLAN information).

7.2.2 Port Configuration

In this menu, you can define and view the rules for receiving frames at the VLAN ports.

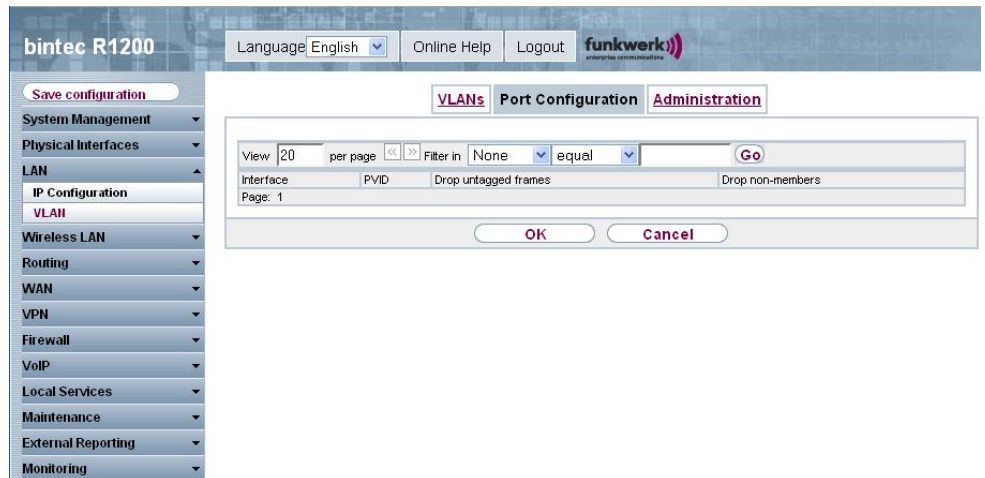

Fig. 89: LAN -> VLAN -> Port Configuration

The LAN ->VLAN-> Port Configuration menu consists of the following fields:

Fields in menu Port Configuration

Field	Description
Interface	Shows the port for which you define the PVID and processing rules.
PVID	Assign the selected port the required PVID (Port VLAN Identifier). If a packet without a VLAN tag reaches this port, it is assigned this PVID.
Drop untagged frames	If this option is enabled, untagged frames are discarded. If the option is disabled, untagged frames are tagged with the PVID defined in this menu.

Field	Description
Drop non-members	If this option is enabled, all tagged frames that are tagged with a VLAN ID to which the selected port does not belong are discarded.

7.2.3 Administration

In this menu, you make general settings for a VLAN. The options must be configured separately for each bridge group.

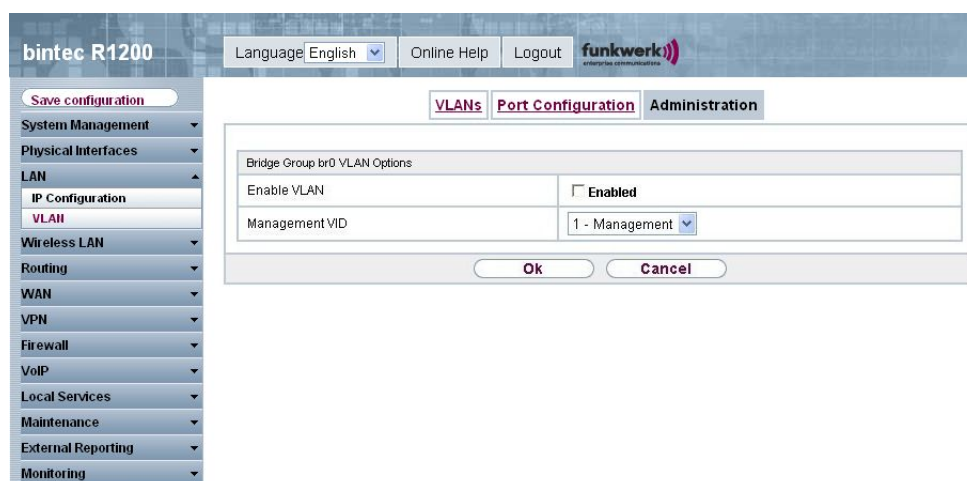

Fig. 90: LAN -> VLAN -> Administration

The LAN -> VLAN -> Administration menu consists of the following fields:

Fields in the Administration Bridge Group br<ID> VLAN Options menu

Field	Description
Enable VLAN	Enable or disable the specified bridge group for VLAN. The function is activated with <i>Enabled</i> . The function is not activated by default.
Management VID	Enter the VLAN ID of the VLAN in which your device is to operate.

Chapter 8 Wireless LAN

In the case of wireless LAN (WLAN = Wireless Local Area Network), this relates to the creation of a network using wireless technology.

Network functions

Like a wired network, a WLAN offers all the main network functions. Access to servers, files, printers, and the e-mail system is just as reliable as company-wide Internet access. Because the devices do not require any cables, the great advantage of WLAN is that there are no building-related restrictions (i.e. the device location does not depend on the position and number of connections).

Currently applicable standard: IEEE 802.11

In the case of 802.11-WLANs, all the functions of a wired network are possible. WLAN transmits inside and outside buildings with a maximum of 100 mW.

IEEE 802.11g is currently the most widespread standard for wireless LANs and offers a maximum data transmission rate of 54 mbps. This procedure operates in the radio frequency range of 2.4 GHz, which ensures that parts of the building are penetrated as effectively as possible with a low transmission power that poses no health risks.

A 802.11g-compatible standard is 802.11b, which operates in the 2.4 GHz range (2400 MHz - 2485 MHz) and offers a maximum data transmission rate of 11 mbps. 802.11b and 802.11g WLAN systems involve no charge or login.

With 802.11a, bandwidths of up to 54 mbps can be used in the 5150 GHz to 5725 MHz range. With the higher frequency range, 19 non-overlapping frequencies are available (in Germany). This frequency range can also be used without a licence in Germany. In Europe, transmission power of not just 30 mW but 1000 mW can be used with 802.11h, but only if TPC (TX Power Control, method for controlling transmission power in wireless systems to reduce interferences) and DFS (Dynamic Frequency Selection) are used. The purpose of TPC and DFS is to ensure that satellite connections and radar devices are not interfered with.

8.1 WLAN1

In the **Wireless LAN** -> **WLAN1** menu, you can configure all the WLAN modules of your device.

Depending on the model, one or two WLAN modules, **WLAN1** and, in certain models, **WLAN2**, available.

8.1.1 Radio Settings

In the **Wireless LAN -> WLAN1 -> Radio Settings** menu, an overview of all the configuration options for the WLAN module is shown.

The screenshot shows the web interface for a bintec R1200 device. The top navigation bar includes the device name 'bintec R1200', a language dropdown set to 'English', and links for 'Online Help' and 'Logout'. The 'funkwerk' logo is also present. A left-hand navigation menu lists various system management options, with 'Wireless LAN' expanded to show 'WLAN1' and 'Administration'. The main content area is titled 'Radio Settings' and contains a table with the following data:





Radio Settings						
MAC Address	Operation Mode	Operation Band	Channel	Maximum Bitrate	Transmit Power	Status
00:00:00:00:00:00	Off	2.4 GHz	Auto	Auto	17 dBm	 

Fig. 91: Wireless LAN -> WLAN1 -> Radio Settings

8.1.1.1 Radio Settings

In this menu, you change the settings for the wireless module.

Choose the  button to edit the configuration.

bintec R1200 Language English Online Help Logout 

[Save configuration](#)

Radio Settings

Wireless Settings	
Radio	<input checked="" type="checkbox"/> Enabled
Operation Mode	Select one
Operation Band	2.4 GHz In/Outdoor
Channel	Auto
Antenna Diversity	<input checked="" type="checkbox"/> Enabled
Max. Link Distance	<input checked="" type="checkbox"/> Use default
Transmit Power	Max.
Performance Settings	
Wireless Mode	802.11 mixed
Max. Transmission Rate	Auto
Nitro Mode	<input checked="" type="checkbox"/> Enabled
Nitro XM	<input type="checkbox"/> Frame Compression <input checked="" type="checkbox"/> Frame Concatenation <input checked="" type="checkbox"/> Piggyback Acknowledge <input checked="" type="checkbox"/> Direct Link

Advanced Settings

Beacon Period	100	ms
DTIM Period	2	
RTS Threshold	Always off	
Short Retry Limit	7	
Long Retry Limit	4	
Fragmentation Threshold	2346	Bytes
ED Threshold	0	
CW Min.	15	
CW Max.	1023	
Max. Receive Lifetime	512	ms
Max. Transmit MSDU Lifetime	512	ms

OK Cancel

Fig. 92: Wireless LAN -> WLAN1 -> Radio Settings-> 

The **Wireless LAN -> WLAN1 -> Radio Settings ->**  menu consists of the following fields:

Fields in the Radio Settings WLAN Settings menu

Field	Description
Radio	Select whether you want to enable the radio. The function is activated by choosing <i>Enabled</i> . The function is enabled by default.

Field	Description
Operation Mode	<p>Define the mode in which the radio module of your device is to operate.</p> <p>Possible values:</p> <ul style="list-style-type: none"> • <i>Select one</i> (default value): The radio module is switched off. • <i>Access Point</i>: Your device is used as an access point in your network. • <i>Access Client</i>: Your device serves as an Access Client in your network.
Client mode	<p>Only for Operating Mode = <i>Access Client</i></p> <p>Select the client connection mode to the access point.</p> <p>Possible values:</p> <ul style="list-style-type: none"> • <i>Infrastructure</i> (default value): In a network in infrastructure mode, all clients communicate with each other via access points only. There is no direct communication between the individual clients. • <i>Ad-Hoc</i>: In ad-hoc mode, an access client can be used as central interface between a number of terminals. In this way, devices such as computers and printers can be wirelessly interconnected. <p>Select the channel to be used.</p>
Operation Band	<p>Select the operation band and usage area of the radio.</p> <p>For Operation Mode = <i>Access Point</i></p> <p>Possible values:</p> <ul style="list-style-type: none"> • <i>2.4 GHz In/Outdoor</i> (default value): our device is operated at 2.4 GHz (mode 802.11b and mode 802.11g), inside or outside buildings. • <i>5 GHz Indoor</i>: Your device is run with 5 GHz (Mode 802.11a/h) inside buildings. • <i>5 GHz In/Outdoor</i>: Your device is run with 5 GHz (Mode 802.11a/h) inside or outside buildings. <p>For Operation Mode = <i>Access Client</i></p>

Field	Description
	<p>Possible values:</p> <ul style="list-style-type: none"> • 2.4 and 5 GHz • 5 and 2.4 GHz (default value) • 5 GHz • 2.4 GHz
Usage Area	<p>Only for Operation Mode = <i>Access Client</i>, Client Mode = <i>Infrastructure</i> and Operation Band = 2.4 and 5 GHz, 5 and 2.4 GHz or 5 GHz</p> <p>Choose the location at which the device is operated.</p> <p>Possible values:</p> <ul style="list-style-type: none"> • <i>Indoor-Outdoor</i> (default value) • <i>Indoor</i> • <i>Outdoor</i>
IEEE 802.11d Compliance	<p>Only for Operating Mode = <i>Access Client</i></p> <p>Select how the country information is determined.</p> <p>Possible values:</p> <ul style="list-style-type: none"> • <i>Flexible</i> (default value): The system attempts to determine the country information of the access point, otherwise the system's own country information is used. • <i>None</i>: The system's own country information is used. • <i>Strict</i>: The country information of the access point is used.
Channel	<p>The number of channels you can selected depends on the country setting. Please consult the data sheet for your device.</p> <p>Access Point mode:</p> <p>Configuring the network name (SSID) in Access Point mode means that wireless networks can be logically separated from each other, but they can still physically interfere with each other if they are operating on the same or closely adjacent wireless channels. So if you are operating two or more radio networks close to each other, it is advisable to allocate the networks to different channels. Each of these should be spaced at least</p>

Field	Description
	<p>four channels apart, as a network also partially occupies the adjacent channels.</p> <p>In the case of manual channel selection, please make sure first that the clients actually support these channels.</p> <p>Possible values:</p> <ul style="list-style-type: none"> • For Frequency Band = <i>2.4 GHz In/Outdoor</i> Possible values are <i>1 to 13</i> and <i>Auto</i> (default value). • For Frequency Band = <i>5 GHz Indoor</i> Possible values are <i>36, 40, 44, 48</i> and <i>Auto</i> (default value) • For Operation Band = <i>5 GHz In/Outdoor</i> and <i>5 GHz Indoor</i> Only the <i>Auto</i> option is possible here. <p>Access Client mode:</p> <p>In Access Client mode you can only select the required channel in Client Mode = <i>Ad Hoc</i>.</p> <p>Possible values:</p> <ul style="list-style-type: none"> • For Frequency Band = <i>2.4 GHz In/Outdoor</i> Possible values are <i>1 to 13</i> and <i>Auto</i> (default value). • For Frequency Band = <i>5 GHz Indoor</i> Possible values are <i>36, 40, 44, 48</i> and <i>Auto</i> (default value) • For Operation Band = <i>5 GHz In/Outdoor</i> and <i>5 GHz Indoor</i> Only the <i>Auto</i> option is possible here.
Antenna Diversity	<p>Select how many and which antennas are used to send and receive.</p> <p>If the function is deactivated, only the main antenna sends and receives.</p> <p>If the function is activated, two antennas receive and the better signal is evaluated.</p>

Field	Description
	<p>The function is activated with <i>Enabled</i>.</p> <p>The function is activated by default.</p>
Max. link range	<p>Enter the maximum link range.</p> <p>If the <i>Use Standard</i> option is enabled, the automatically generated range is used.</p> <p>If this option is not enabled, enter the desired maximum value in the <i>m</i> field.</p> <p>The <i>Use Standard</i> option is enabled by default.</p>
Transmit Power	<p>Select the maximum value for the radiated antenna power. The actually radiated antenna power may be lower than the maximum value set, depending on the data rate transmitted. The maximum value for Transmit Power is country-dependent.</p> <p>Possible values:</p> <ul style="list-style-type: none"> • <i>max.</i> (default value): The maximum antenna power is used. • <i>User Defined</i>: Enter the required maximum value in dBm in the input field. • <i>2 mW 3 dBm</i> • <i>5 mW 7 dBm</i> • <i>10 mW 10 dBm</i> • <i>40 mW 16 dBm</i>

Fields in the Radio Settings Performance Settings menu

Field	Description
Wireless Mode	<p>Only for Operation Band = 2.4 GHz In/Outdoor</p> <p>Select the wireless technology that the access point is to use.</p> <p>Possible values:</p> <ul style="list-style-type: none"> • <i>11g</i>: The device operates only in accordance with 802.11g. 802.11b clients have no access. • <i>11b</i>: Your device operates only in accordance with 802.11b and forces all clients to adapt to it.

Field	Description
	<ul style="list-style-type: none"> • <i>802.11 mixed</i> (default value) / <i>802.11 mixed-short</i>: Your device adapts to the client technology. The following applies for mixed-short: The data rates 5.5 and 11 mbps must be supported by all clients (basic rates). • <i>802.11 mixed-long</i>: Your device adapts to the client technology. Only a data rate of 1 and 2 mbps needs to be supported by all clients (basic rates). This mode is also needed for Centrino clients if connection problems occur.
Max. Transmission Rate	<p>Select the transmission speed.</p> <p>Possible values:</p> <ul style="list-style-type: none"> • <i>Autodetect</i> (default value): The transmission speed is determined automatically. • <i>1, 2, 5, 6, 9, 11, 12, 18, 24, 36, 48, 54 mbps</i>
Nitro Mode	<p>Activate this function to increase the transmission speed for 802.11g through frame bursting. As a result, several packets are sent one after the other without a waiting period. This is particularly effective in 11b/g mixed operation.</p> <p>The function is activated with <i>Enabled</i>.</p> <p>The function is activated by default.</p> <p>If problems occur with older WLAN hardware, this function should be deactivated.</p>
Nitro XM	<p>The Nitro XM (eXtreme Multimedia) function can increase throughput by combining Protection (avoids collisions in radio cells with 11g and 11b clients), Packet Bursting (sending of several data packets together; already implemented with the name Nitro), Compression and Concatenation (combines several smaller packets into one larger WLAN packet).</p> <p>Possible values:</p> <ul style="list-style-type: none"> • <i>Frame Compression</i>: If this function is activated, sent data is compressed. This only works in combination with clients that use Conexant radio cards. The gain in transmission speed depends to a large extent on the type of transmitted data.

Field	Description
	<ul style="list-style-type: none"> • <i>Frame Concatenation</i>: If this function is activated, several small data packets are combined to form larger ones. This only works in combination with clients that use Conexant radio cards. • <i>Piggyback Acknowledge</i>: If this function is activated, the confirmation for received packets ("ACK") is combined with other sent packages. This only works in combination with clients that use Conexant radio cards. • <i>Direct Link</i>: If "Direct link" is activated, logged-on clients can exchange data directly, without routing via the access point. This only works in combination with clients that use Conexant radio cards. <p>By default, <i>Frame Concatenation</i>, <i>Piggyback Acknowledge</i> and <i>Direct Link</i> are activated.</p>

The **Advanced Settings** menu consists of the following fields:

Fields in the Advanced Settings menu

Field	Description
Beacon Period	<p>Only for Operation Mode = <i>Access Point</i> or <i>Select one</i>.</p> <p>Enter the time in milliseconds between the sending of two beacons.</p> <p>This value is transmitted in Beacon and Probe Response Frames.</p> <p>Possible values are 1 to 65535.</p> <p>The default value is 100 msec.</p>
DTIM Period	<p>Only for Operation Mode = <i>Access Point</i> or <i>Select one</i>.</p> <p>Enter the interval for the Delivery Traffic Indication Message (DTIM).</p> <p>The DTIM field is a data field in transmitted beacons that informs clients about the window to the next broadcast or multicast transmission. If clients operate in power save mode, they come alive at the right time and receive the data.</p> <p>Possible values are 1 to 255.</p>

Field	Description
	The default value is 2.
RTS Threshold	<p>Here, you select how the RTS/CTS mechanism is to be switched on/off.</p> <p>If you choose <i>User Defined</i>, in the input field you can specify the data packet length threshold in bytes (1..2346) as of which the RTS/CTS mechanism is to be used. This makes sense if several clients that are not in each other's wireless range are run in one access point. The mechanism can also be switched on/off independently of the data packet length by selecting the value <i>Always on</i> or <i>Always off</i> (default value).</p>
Short Retry Limit	<p>Enter the maximum number of attempts to send a frame of length less than or equal to the value defined in RTS Threshold. After this many failed attempts, the packet is discarded.</p> <p>Possible values are 1 to 255.</p> <p>The default value is 7.</p>
Long Retry Limit	<p>Enter the maximum number of attempts to send a data packet of length less than or equal to the value defined in RTS Threshold. After this many failed attempts, the packet is discarded.</p> <p>Possible values are 1 to 255.</p> <p>The default value is 4.</p>
Fragmentation Threshold	<p>Enter the maximum size as of which the data packets are to be fragmented (i.e. split into smaller units). A low value is recommended for this field in areas with poor reception and in the event of radio interference.</p> <p>Possible values are 256 to 2346.</p> <p>The default value is 2346 bytes.</p>
ED Threshold	<p>Define the Energy Detection threshold for CCA (Clear Channel Assessment).</p> <p>Possible values are -2147483648 to 2147483647.</p>

Field	Description
	The default value is <i>0</i> .
CW Min	Define the maximum size of the contention window. Possible values are <i>1</i> to <i>65535</i> . The default value is <i>15</i> .
CW Max	Define the minimum size of the contention window. Possible values are <i>1</i> to <i>65535</i> . The default value is <i>1023</i> .
Max Receive Lifetime	Enter the time from receipt of the first fragment of a data packet as of which no further attempts are made. The data packet is discarded. Possible values are <i>1</i> to <i>4294967295</i> . The default value is <i>512</i> msec.
Max Transmit MSDU Lifetime	Enter the time from sending of the first fragment of a data packet as of which no further send attempts are made. The data packet is discarded. Possible values are <i>1</i> to <i>4294967295</i> . The default value is <i>512</i> msec.

Fields in the Advanced Settings Client Mode menu

Field	Description
Scan Channels	Only for Operating Mode = <i>Access Client</i> Choose the channels which the WLAN client automatically scans for available wireless networks. The function is enabled by default. All channels are scanned. If the function is disabled, you can define the required channels under Selected Channels .
Selected Channels	Only for Scan channels = <i>disabled</i> Define the channels which the WLAN client automatically scans for available wireless networks.



Field	Description
Roaming Profile	<p>Select the roaming profile. The options available include typical roaming functions.</p> <p>Possible values:</p> <ul style="list-style-type: none"> • <i>Fast Roaming</i>: The WLAN client searches for available wireless networks as soon as the radio signal of the existing radio connection becomes unsuitable for higher data rates. • <i>Normal Roaming</i> (default value): Standard roaming. • <i>Slow Roaming</i>: The WLAN client searches for available wireless networks as soon as the radio signal of the existing radio connection becomes weaker. • <i>No Roaming</i>: The WLAN client searches for available wireless networks if it is no longer connected to a wireless network. • <i>Custom Roaming</i>: Specify the individual roaming parameters.
Scan Threshold	<p>Indicates the value in dBm above which the system scans for available wireless networks in the background.</p> <p>The value can only be changed for Roaming Profile = <i>Custom Roaming</i>. The default value is <i>-70 dBm</i>.</p>
Scan Interval	<p>Indicates the interval in milliseconds after which the system scans for available wireless networks.</p> <p>The value can only be changed for Roaming Profile = <i>Custom Roaming</i>. The default value is <i>5000 ms</i>.</p>
Channel Sweep	<p>Indicates how many frequencies are scanned in the background.</p> <p>The value can only be changed for Roaming Profile = <i>Custom Roaming</i>. The default value is <i>2</i>. The value <i>0</i> disables the scan in the background. The value <i>-1</i> enables the scan of all available frequencies.</p>
Min. Time Period for Active Scan	<p>Indicates the minimum time in milliseconds a frequency is actively scanned.</p> <p>The value can only be changed for Roaming Profile = <i>Custom Roaming</i>. The default value is <i>10 ms</i>.</p>
Max. Time Period for	<p>Indicates the maximum time in milliseconds a frequency is act-</p>

Field	Description
Active Scan	<p>ively scanned.</p> <p>The value can only be changed for Roaming Profile = <i>Custom Roaming</i>. The default value is <i>40 ms</i>.</p>
Min. Time Period for Passive Scan	<p>Indicates the minimum time in milliseconds a frequency is passively scanned.</p> <p>The value can only be changed for Roaming Profile = <i>Custom Roaming</i>. The default value is <i>20 ms</i>.</p>
Max. Time Period for Passive Scan	<p>Indicates the maximum time in milliseconds a frequency is actively scanned.</p> <p>The value can only be changed for Roaming Profile = <i>Custom Roaming</i>. The default value is <i>120 ms</i>.</p>
Association Advantage	<p>Indicates which priority assigned to the BSS currently connected to the WLAN client.</p> <p>The value can only be changed for Roaming Profile = <i>Custom Roaming</i>. The default value is <i>10</i>.</p>
RSSI Advantage	<p>Indicates which priority is assigned to the signal strength indicator (RSSI) of the BSS.</p> <p>The value can only be changed for Roaming Profile = <i>Custom Roaming</i>. The default value is <i>10</i>.</p>
Weight of Age	<p>Indicates the priority of the age of the BSS.</p> <p>The value can only be changed for Roaming Profile = <i>Custom Roaming</i>. The default value is <i>5</i>.</p>
Weight of Penalty	<p>Indicates the priority of the penalty of the BSS.</p> <p>The value can only be changed for Roaming Profile = <i>Custom Roaming</i>. The default value is <i>10</i>.</p>
Penalty Value	<p>Indicates the value of the penalty of the BSS.</p> <p>The value can only be changed for Roaming Profile = <i>Custom Roaming</i>. The default value is <i>50</i>.</p>
RTS Threshold	<p>Select how the RTS/CTS mechanism is to be switched on/off.</p> <p>If you choose <i>User Defined</i>, in the input field you can specify the data packet length threshold in bytes (1..2346) as of which the RTS/CTS mechanism is to be used. This makes sense if several clients that are not in each other's wireless range are</p>

Field	Description
	run in one access point. The mechanism can also be switched on/off independently of the data packet length by selecting the value <i>Always on</i> or <i>Always off</i> (default value).
Short Retry Limit	<p>Enter the maximum number of attempts to send a frame of length less than or equal to the value defined in RTS Threshold. After this many failed attempts, the packet is discarded.</p> <p>Possible values are <i>1</i> to <i>255</i>.</p> <p>The default value is <i>7</i>.</p>
Long Retry Limit	<p>Enter the maximum number of attempts to send a data packet of length less than or equal to the value defined in RTS Threshold. After this many failed attempts, the packet is discarded.</p> <p>Possible values are <i>1</i> to <i>255</i>.</p> <p>The default value is <i>4</i>.</p>
Fragmentation Threshold	<p>Enter the maximum size as of which the data packets are to be fragmented (i.e. split into smaller units). A low value is recommended for this field in areas with poor reception and in the event of radio interference.</p> <p>Possible values are <i>256</i> to <i>2346</i>.</p> <p>The default value is <i>2346</i> bytes.</p>
ED Threshold	<p>Define the Energy Detection threshold for CCA (Clear Channel Assessment).</p> <p>Possible values are <i>-2147483648</i> to <i>2147483647</i>.</p> <p>The default value is <i>0</i>.</p>
CW Min.	<p>Define the maximum size of the contention window.</p> <p>Possible values are <i>1</i> to <i>65535</i>.</p> <p>The default value is <i>15</i>.</p>
CW Max.	<p>Define the minimum size of the contention window.</p>

Field	Description
	Possible values are 1 to 65535. The default value is 1023.
Max. Receive Lifetime	Enter the time from receipt of the first fragment of a data packet as of which no further attempts are made. The data packet is discarded. Possible values are 1 to 4294967295. The default value is 512 msec.
Max. Transmit MSDU Lifetime	Enter the time from sending of the first fragment of a data packet as of which no further send attempts are made. The data packet is discarded. Possible values are 1 to 4294967295. The default value is 512 msec.

8.1.2 Virtual Service Sets

If you operate your device in access point mode (**Wireless LAN** -> **WLAN1** -> **Radio Settings** ->  -> **Operating Mode** = *Access Point*), you can set up and edit the desired wireless networks in the **Wireless LAN** -> **WLAN1** -> **Virtual Service Sets** ->  -> /New menu.

Setting network names

In contrast to a LAN set up over Ethernet, a wireless LAN does not have any cables for setting up a permanent connection between the server and clients. Access violations or faults may therefore occur with directly adjacent radio networks. To prevent this, every radio network has a parameter that uniquely identifies the network and is comparable with a domain name. Only clients with a network configuration that matches that of your device can communicate in this WLAN. The corresponding parameter is called the network name. In the network environment, it is sometimes also referred to as the SSID.

Protection of wireless networks

As data can be transmitted over the air in the WLAN, this data can in theory be intercepted and read by any attacker with the appropriate resources. Particular attention must therefore be paid to protecting the wireless connection.

There are three security modes, WEP, WPA-PSK and WPA Enterprise. WPA Enterprise offers the highest level of security, but this security mode is only really suitable for companies, because it requires a central authentication server. Private users should choose WEP or preferably WPA-PSK with higher security as their security mode.

WEP

802.11 defines the WEP security standard (Wired Equivalent Privacy = encryption of data with 40 bits (**Security Mode** = *WEP 40*) or 104 bits (**Security Mode** = *WEP 104*). However, this widely used WEP has proven susceptible to failure. However, a higher degree of security can only be achieved through hardware-based encryption which required additional configuration (for example 3DES or AES). This permits even sensitive data from being transferred via a radio path without fear of it being stolen.

IEEE 802.11i

Standard IEEE 802.11i for wireless systems contains basic security specifications for wireless networks, in particular with regard to encryption. It replaces the insecure WEP (Wired Equivalent Privacy) with WPA (Wi-Fi Protected Access). It also includes the use of the advanced encryption standard (AES) to encrypt data.

WPA

WPA (Wi-Fi Protected Access) offers additional protection by means of dynamic keys based on the Temporal Key Integrity Protocol (TKIP), and offers PSK (preshared keys) or Extensible Authentication Protocol (EAP) via 802.1x (e.g. RADIUS) for user authentication.

Authentication using EAP is usually used in large wireless LAN installations, as an authentication instance in the form of a server (e.g. a RADIUS server) is used in these cases. PSK (preshared keys) are usually used in smaller networks, such as those seen in SoHo (Small office, Home office). Therefore, all the wireless LAN subscribers must know the PSK, because it is used to generate the session key.

WPA2

WPA2 is the enhancement of WPA. In WPA2, the 802.11i standard is not only implemented for the first time in full, but another encryption algorithm AES (Advanced Encryption Standard) is also used.

Access control

You can control which clients can access your wireless LAN via your device by creating an Access control list (**ACL Mode** or **MAC Filter**). In the Access Control List, you enter the MAC addresses of the clients that may access your wireless LAN. All other clients have no

access.

Security measures

To protect the data transferred on the WLAN, you may need to carry out the following configuration steps in the **Wireless LAN -> WLAN1 -> Virtual Service Sets ->New->** menu:

- Change the access passwords for your device.
- Change the default SSID, **Network Name (SSID)** = *Funkwerk-ec* , of your access point. Set **Visible** = *Enabled*. This will exclude all WLAN clients that attempt to establish a connection with the general value for **Network Name (SSID)** *Any* and do not know the SSID settings.
- Use the available encryption methods. To do this, select **Security Mode** = *WEP 40*, *WEP 104* , *WPA PSK* or *WPA Enterprise* or both, and enter the relevant key in the access point under **WEP Key1 - 4** or **Preshared Key** and in the WLAN clients.
- The WEP key should be changed regularly. To do this, change the **Data Transfer Key** . Select the longer 104 Bit WEP key.
- For the transfer of highly security-critical information, **Security Mode** = *WPA-Enterprise* should be configured with **WPA Mode** = *WPA 2*. This method contains hardware-based encryption and RADIUS authentication of the client. In special cases, combination with IPsec is possible.
- Restrict WLAN access to permitted clients. Enter the MAC addresses of the wireless network cards of these clients in the **Permitted Addresses**-list in the **MAC Filter** menu (see [Fields in the Virtual Service Sets MAC-Filter menu](#) on page 212).

In the **Wireless LAN -> WLAN1 -> Virtual Service Sets** menu, a list of all WLAN networks shown.

8.1.2.1 Virtual Service Sets ->New/

Choose the  icon to edit existing entries. Choose the **New** button to configure other wireless networks.

The screenshot shows the configuration interface for a bintec R1200 device. The top navigation bar includes 'Language English', 'Online Help', 'Logout', and the 'funkwerk' logo. The sidebar on the left contains a tree view with categories like System Management, Physical Interfaces, LAN, Wireless LAN, and Routing. The 'Wireless LAN' section is expanded to show 'WLAN1' and 'Administration'. The main configuration area is titled 'Radio Settings' and 'Virtual Service Sets'. It contains a 'Service Set Parameters' section with the following fields:

- Network Name (SSID): Funkwerk-ec, Enabled
- Intra-cell Repeating: Enabled
- ARP Processing: Enabled
- WMM: Enabled
- Security Settings: Security Mode: Inactive
- MAC-Filter: MAC Address: [] Add
- ACL Mode: Enabled
- Allowed Addresses: [] Add

At the bottom of the configuration area are 'OK' and 'Cancel' buttons.

Fig. 93: Wireless LAN -> WLAN1 -> Virtual Service Sets -> /New

The **Wireless LAN -> WLAN1 -> Virtual Service Sets (VSS) -> /New** menu consists of the following fields:

Fields in the Virtual Service Sets Service Set Parameters menu

Field	Description
Network Name (SSID)	<p>Enter the name of the wireless network (SSID).</p> <p>Enter an ASCII string with a maximum of 32 characters.</p> <p>Also select whether the Network Name (SSID) is to be transmitted.</p> <p>The function is activated by choosing <i>Visible</i>.</p> <p>The function is enabled by default.</p>
Intra-cell Repeating	<p>Select whether communication between the WLAN clients is to be permitted within a radio cell.</p> <p>The function is activated by choosing <i>Enabled</i>.</p> <p>The function is enabled by default.</p>
ARP Processing	<p>Select whether the ARP processing function should be enabled.</p> <p>The ARP data traffic is reduced in the network by the fact that ARP broadcasts that have been converted to ARP unicasts are forwarded to IP addresses that are known internally. Unicasts</p>

Field	Description
	<p>are quicker and clients with an enabled power save function are not addressed.</p> <p>The function is activated by choosing <i>Enabled</i>.</p> <p>The function is disabled by default.</p> <p>Make sure that ARP processing cannot be applied in conjunction with the MAC bridge function.</p>
WMM	<p>Select whether voice or video prioritisation via WMM (Wireless Multimedia) is to be activated for the wireless network so that optimum transmission quality is always achieved for time-critical applications. Data prioritisation is supported in accordance with DSCP (Differentiated Services Code Point) or IEEE802.1d.</p> <p>The function is activated by choosing <i>Enabled</i>.</p> <p>The function is enabled by default.</p>

Fields in the Virtual Service Sets Security Settings menu

Field	Description
Security Mode	<p>Select the security mode (encryption and authentication) for the wireless network.</p> <p>Possible values:</p> <ul style="list-style-type: none"> • <i>Inactive</i> (default value): Neither encryption nor authentication • <i>WEP 40</i>: WEP 40 Bit • <i>WEP 104</i>: WEP 104 Bit • <i>WPA-PSK</i>: WPA Preshared Key • <i>WPA-Enterprise</i>: 802.11i/TKIP
Transmit Key	<p>Only if Security Mode = <i>WEP 40</i>, <i>WEP 104</i></p> <p>Select one of the keys configured in WEP Key <1 - 4> as the default key.</p> <p>The default value is <i>Key 1</i>.</p>
WEP Key 1-4	<p>Only if Security Mode = <i>WEP 40</i>, <i>WEP 104</i></p>



Field	Description
	<p>Enter the WEP key.</p> <p>Enter a character string with the right number of characters for the selected WEP mode. For <i>WEP 40</i> you need a string of 5 characters, <i>WEP 104</i> 13 characters. For example <i>hello</i> for <i>WEP 40</i>, <i>funkwerk-wep1</i> for <i>WEP 104</i>.</p>
WPA Mode	<p>Only if Security Mode = <i>WPA-PSK</i> and <i>WPA-Enterprise</i></p> <p>Select whether you want to use WPA (with TKIP encryption) or WPA 2 (with AES encryption), or both.</p> <p>Possible values:</p> <ul style="list-style-type: none"> • <i>WPA and WPA 2</i> (default value): WPA and WPA 2 can be used. • <i>WPA</i> : Only WPA is used. • <i>WPA 2</i> : Only WPA2 is used.
WPA Cipher	<p>Only for Security Mode = <i>WPA-PSK</i> and WPA Mode = <i>WPA</i> or <i>WPA and WPA2</i></p> <p>Select which encryption method should be used.</p> <p>Possible values:</p> <ul style="list-style-type: none"> • <i>TKIP</i> (default value): Temporal Key Integrity Protocol. • <i>AES</i>: Advanced Encryption Standard. • <i>AES and TKIP</i> <p>Both encryption methods are rated as secure, with AES offering better performance.</p>
WPA2 Cipher	<p>Only if Security Mode = <i>WPA-PSK</i></p> <p>and WPA Mode = <i>WPA2</i> or <i>WPA and WPA2</i></p> <p>Select which encryption method should be used.</p> <p>Possible values:</p> <ul style="list-style-type: none"> • <i>TKIP</i> (default value): Temporal Key Integrity Protocol. • <i>AES</i>: Advanced Encryption Standard. • <i>AES and TKIP</i>

Field	Description
	Both encryption methods are rated as secure, with AES offering better performance.
Preshared Key	<p>Only if Security Mode = <i>WPA-PSK</i></p> <p>Enter the WPA password.</p> <p>Enter an ASCII string with 8 - 63 characters.</p>

Fields in the Virtual Service Sets MAC-Filter menu

Field	Description
ACL Mode	<p>Select whether only certain clients are to be permitted for this wireless network.</p> <p>The function is activated by choosing <i>Enabled</i>.</p> <p>The function is disabled by default.</p>
Allowed Addresses	Use Add here to make entries and enter the MAC addresses (MAC Address) of the clients to be permitted.

8.1.3 WDS Links

If you operate your device in access point mode (**Wireless LAN** -> **WLANx** -> **Radio Settings** ->  -> **Operating Mode** = *Access Point*), you can set up and edit the desired WDS links in the **Wireless LAN** -> **WLANx** -> **WDS links** ->  -> **New** menu.



Important

Select the channel to be used. The WDS link can only be configured in the 2.4 GHz band if the channel is NOT *Auto*.

The number of channels you can selected depends on the country setting. Please consult the data sheet for your device.

WDS links (WDS = Wireless Distribution System) are static links between access points (AP), which are generally used to connect clients with networks that are not directly accessible to them e.g. because the distance is too great. The access point sends from one client to another access point, which then forwards the data to another client.



Important

Note that the data is transferred between the access points in unencrypted form over the WDS link in the default configuration. You are therefore urgently advised to apply one of the available security methods (WEP40 or WEP104) to protect data on WDS links.

WDS links are configured as interfaces with the prefix *wds*. They behave like VSS interface and only differ from these with respect to the predefined routing. A WDS link is defined as a transit network: this relates to a point-to-point connection or point-to-multipoint connection between two access points that are included in different networks.

8.1.3.1 WDS Links -> New

Choose the  icon to edit existing entries. Choose the **New** button to configure other WDS links.

The screenshot shows the web interface for a bintec R1200 device. The top navigation bar includes 'Language English', 'Online Help', 'Logout', and the 'funkwerk' logo. A left sidebar contains a menu with categories like 'System Management', 'Physical Interfaces', 'Wireless LAN', 'Routing', etc. The 'Wireless LAN' section is expanded to show 'WLAN1' and 'Administration'. The main content area has three tabs: 'Radio Settings', 'Virtual Service Sets', and 'WDS Links'. The 'WDS Links' tab is selected, displaying a configuration form. The form has a 'Basic Parameters' section with the following fields: 'WDS Description' with a checked 'Use default' option, 'WDS Security Settings' with 'Privacy' set to 'None', 'Remote Partner' (empty), and 'Remote MAC Address' set to '00:00:00:00:00:00'. At the bottom of the form are 'OK' and 'Cancel' buttons.

Fig. 94: Wireless LAN -> WLANx -> WDS Links ->  -> /New

The **Wireless LAN -> WLANx -> WDS Links ->  -> /New** menu consists of the following fields:

Fields in the Basic Parameters menu

Field	Description
WDS Description	Enter a name for the WDS link. If the <i>Use default</i> option is activated, the generated name of

Field	Description
	<p>the interface is automatically used.</p> <p>If the option is not activated, you can enter a suitable name in the input field.</p> <p>The <i>Use Standard</i> option is enabled by default.</p>

Fields in the WDS Security Settings menu



Field	Description
Privacy	<p>Select whether an encryption method is to be used for this WDS link and if so, which one.</p> <p>Possible values:</p> <ul style="list-style-type: none"> • <i>None</i> (default value): Data traffic on this WDS link is not encrypted. • <i>WEP40</i>: Data traffic on this WDS link is encrypted with WEP40. In WEP Key 1 - 4, enter the key for this WDS link and in Transmission Key, select the default key. • <i>WEP104</i>: Data traffic on this WDS link is encrypted with WEP104. In WEP Key 1 - 4, enter the key for this WDS link and in Transmission Key, select the default key.
Transmit Key	<p>Only if Privacy = <i>WEP40</i> , <i>WEP104</i></p> <p>Select one of the keys configured in WEP Key <1 - 4> as the default key.</p> <p>The default value is <i>Key 1</i>.</p>
WEP Key 1 - 4	<p>Only if Privacy = <i>WEP40</i>, <i>WEP104</i></p> <p>Enter the WEP key. There are two ways of entering a WEP key:</p> <ul style="list-style-type: none"> • Direct entry in hexadecimal form <p>If the entry starts with <i>0x</i>, the generator is deactivated. Enter a hexadecimal string with exactly the right number of characters for the selected WEP mode. 10 characters for <i>WEP40</i> or 26 characters for <i>WEP104</i> e.g. <i>WEP40: 0xA0B23574C5</i>, <i>WEP104: 0x81DC9BDB52D04DC20036DBD831</i></p> <ul style="list-style-type: none"> • Direct entry of ASCII characters

Field	Description
	Enter a character string with the right number of characters for the selected WEP mode. For <i>WEP40</i> you need a string of 5 characters, <i>WEP104</i> 13 characters. For example <i>hello</i> for <i>WEP40</i> , <i>funkwerk-wep1</i> for <i>WEP104</i> .

Fields in the Remote Partner menu

Field	Description
Remote MAC Address	Enter the MAC address of the WDS partner.

8.1.4 Client Link

If you operate your device in access client mode (**Wireless LAN** -> **WLAN1** -> **Radio Settings** ->  -> **Operating Mode** = *Access Client*), you can set up and edit the available Client Links in the **Wireless LAN** -> **WLAN1** -> **Client Links** ->  -> menu.

The client mode can be operated in infrastructure mode or in ad-hoc mode.

In a network in infrastructure mode, all clients communicate with each other via access points only. There is no direct communication between the individual clients.

In ad-hoc mode, an access client can be used as central interface between a number of terminals. In this way, devices such as computers and printers can be wirelessly interconnected.

8.1.4.1 Client Link ->

Choose the  icon to edit existing entries.

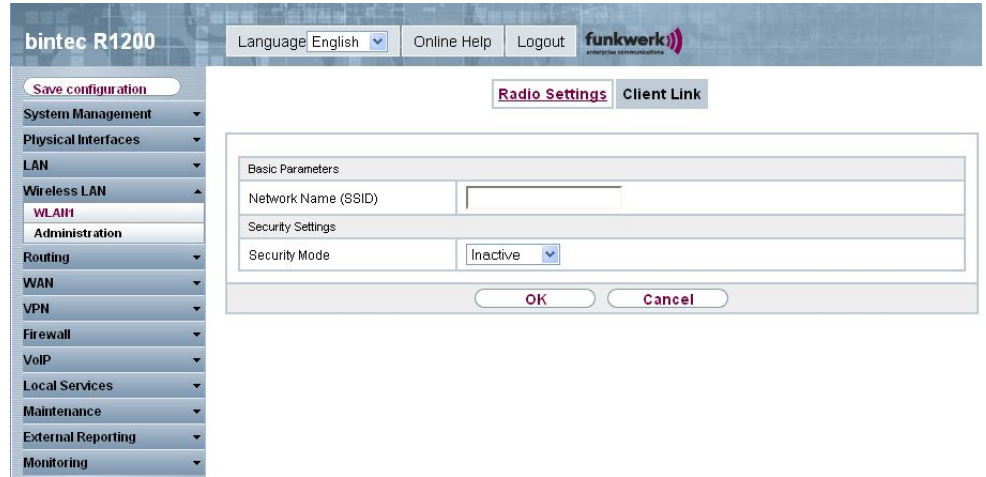



Fig. 95: Wireless LAN -> WLAN1 -> Client Link -> 

The Wireless LAN -> WLAN1 -> Client Link -> -> menu consists of the following fields:

Fields in the Client Link Basic Parameters menu

Field	Description
Network Name (SSID)	Enter the name of the wireless network (SSID). Enter an ASCII string with a maximum of 32 characters.

Fields in the Client Link Security Settings menu

Field	Description
Security Mode	Select the security mode (encryption and authentication) for the wireless network. Possible values: <ul style="list-style-type: none"> • <i>Inactive</i> (default value): Neither encryption nor authentication • <i>WEP 40</i>: WEP 40 Bit • <i>WEP 104</i>: WEP 104 Bit • <i>WPA-PSK</i>: WPA Preshared Key

Field	Description
Transmit Key	<p>Only if Security Mode = <i>WEP 40</i>, <i>WEP 104</i></p> <p>Select one of the keys configured in WEP Key <1 - 4> as the default key.</p> <p>The default value is <i>Key 1</i>.</p>
WEP Key 1-4	<p>Only if Security Mode = <i>WEP 40</i>, <i>WEP 104</i></p> <p>Enter the WEP key.</p> <p>Enter a character string with the right number of characters for the selected WEP mode. For <i>WEP 40</i> you need a string of 5 characters, <i>WEP 104</i> 13 characters. For example <i>hello</i> for <i>WEP 40</i>, <i>funkwerk-wep1</i> for <i>WEP 104</i>.</p>
WPA Mode	<p>Only if Security Mode = <i>WPA-PSK</i> and <i>WPA-Enterprise</i></p> <p>Select whether you want to use WPA (with TKIP encryption) or WPA 2 (with AES encryption), or both.</p> <p>Possible values:</p> <ul style="list-style-type: none"> • <i>WPA</i> (default value): Only WPA is used. • <i>WPA 2</i> : Only WPA2 is used.
Preshared Key	<p>Only if Security Mode = <i>WPA-PSK</i></p> <p>Enter the WPA password.</p> <p>Enter an ASCII string with 8 - 63 characters.</p>
WPA Cipher	<p>Only for Security Mode = <i>WPA-PSK</i> and WPA Mode = <i>WPA</i></p> <p>Select which encryption method should be used.</p> <p>Possible values:</p> <ul style="list-style-type: none"> • <i>TKIP</i> (default value): Temporal Key Integrity Protocol. • <i>AES</i>: Advanced Encryption Standard. • <i>AES and TKIP</i> <p>Both encryption methods are rated as secure, with AES offering better performance.</p>

Field	Description
WPA2 Cipher	<p>Only for Security Mode = <i>WPA-PSK</i> and WPA Mode = <i>WPA2</i></p> <p>Select which encryption method should be used.</p> <p>Possible values:</p> <ul style="list-style-type: none"> • <i>TKIP</i> (default value): Temporal Key Integrity Protocol. • <i>AES</i>: Advanced Encryption Standard. • <i>AES and TKIP</i> <p>Both encryption methods are rated as secure, with AES offering better performance.</p>

8.1.4.2 Client Link Scan

After the desired **Client Links** have been configured, the  icon is shown in the list.

You use this icon to open the **Scan** menu.

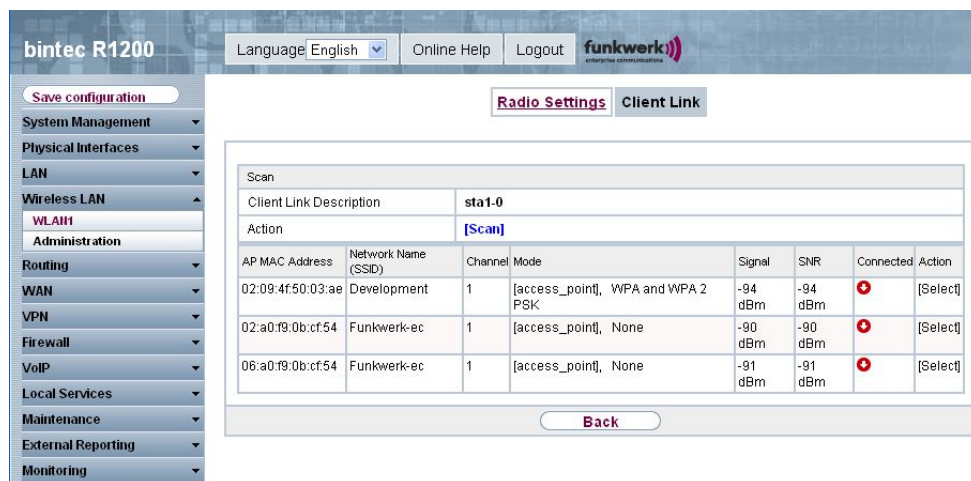





Scan							
Client Link Description		sta1-0					
Action		[Scan]					
AP MAC Address	Network Name (SSID)	Channel	Mode	Signal	SNR	Connected	Action
02:09:4f:50:03:ae	Development	1	[access_point], WPA and WPA 2 PSK	-94 dBm	-94 dBm		[Select]
02:a0:f9:0b:cf:54	Funkwerk-ec	1	[access_point], None	-90 dBm	-90 dBm		[Select]
06:a0:f9:0b:cf:54	Funkwerk-ec	1	[access_point], None	-91 dBm	-91 dBm		[Select]

Fig. 96: Wireless LAN -> WLAN1 -> Client Link -> Scan

After successful scanning, a selection of potential scan partners is displayed in the scan list. In the **Action** column, click **[Select]** to connect the local clients with this client. If the partners are connected with one another, the  icon appears in the **Connected** column.

The  icon appears in the **Connected** column if the connection is active.

The **Wireless LAN -> WLAN1 -> Client Link -> Scan** menu consists of the following fields:

Fields in the Client Link Scan menu

Field	Description
Client Link Description	Displays the name of the client link you configured.
Action	<p>Start the scan by clicking on Scan.</p> <p>If the antennas are installed correctly on both sides and LOS is free, the client finds available clients and displays them in the following list.</p> <p>If the partner client cannot be found, check the line of sight and the antenna installation. Then carry out the Scan again. The partner should then be found.</p>
AP MAC Address	Shows the MAC address of the remote client.
Network Name (SSID)	Displays the name of the remote client.
Channel	Shows the Channel used.
Mode	Shows the security mode (encryption and authentication) for the wireless network.
Signal	Displays the signal strength of the detected client link in dBm.
SNR	Shows the signal quality in dBm.
Connected	Displays the status of the link on your client.
Action	You can change the status of the client link. The available actions are displayed in this field.

8.2 Administration

The **Wireless LAN -> Administration** menu contains basic settings for running your gateway as an access point (AP).

8.2.1 Basic settings

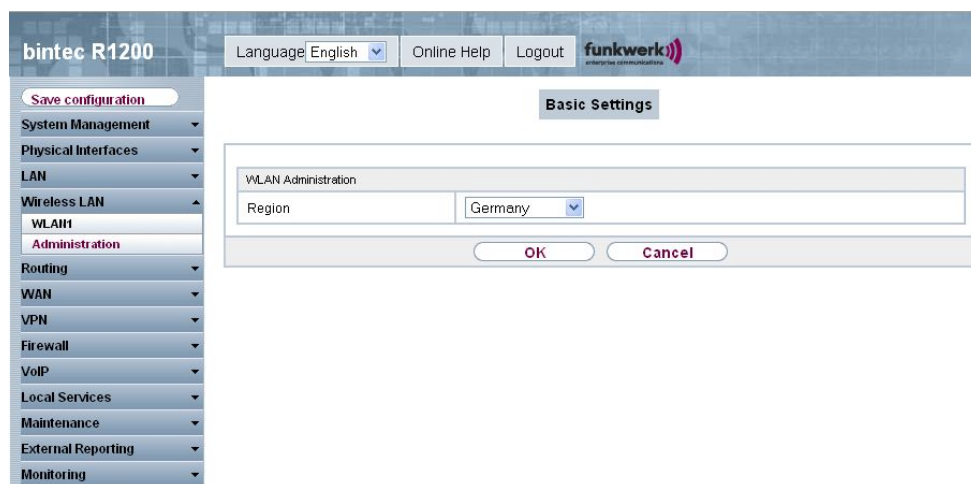

Fig. 97: Wireless LAN -> Administration -> Basic Settings

The **Wireless LAN -> Administration -> Basic Settings** menu consists of the following fields:

Fields in the Basic Settings WLAN Administration menu

Field	Description
Region	<p>Select the country in which the access point is to be run.</p> <p>Possible values are all the countries configured on the gateway's wireless module.</p> <p>The range of channels available for selection (Channel in the WLAN Wireless Modules menu) changes depending on the country setting.</p> <p>The default value is <i>Germany</i>.</p>

Chapter 9 Routing

9.1 Routes

9.1.1 IP routes

In the **Routing** -> **Routes** -> **IP Routes** menu a list of all configured routes is shown.

9.1.1.1 New

Choose the **New** button to create routes.

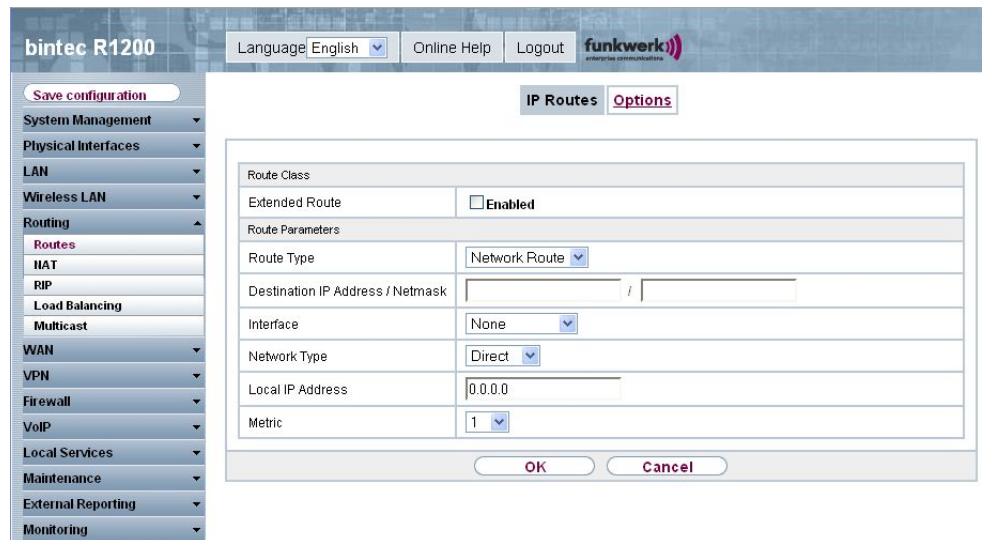

The screenshot shows the web interface for a bintec R1200 device. The top navigation bar includes 'Language English', 'Online Help', 'Logout', and the 'funkwerk' logo. A left sidebar contains a menu with categories like 'System Management', 'Physical Interfaces', 'LAN', 'Wireless LAN', 'Routing', 'WAN', 'VPN', 'Firewall', 'VoIP', 'Local Services', 'Maintenance', 'External Reporting', and 'Monitoring'. The 'Routing' section is expanded, showing 'Routes' as the selected option. The main content area is titled 'IP Routes' and has an 'Options' tab. The configuration form includes the following fields:

Route Class	
Extended Route	<input type="checkbox"/> Enabled

Route Parameters	
Route Type	Network Route
Destination IP Address / Netmask	<input type="text"/> / <input type="text"/>
Interface	None
Network Type	Direct
Local IP Address	0.0.0.0
Metric	1

At the bottom of the form are 'OK' and 'Cancel' buttons.

Fig. 98: **Routing** -> **Routes** -> **IP Routes**-> **New** with **Extended Route** = *Not Enabled*

If the *Extended Route* option is selected for **Route Class**, an extra configuration section opens.

The screenshot shows the 'bintec R1200' web interface. At the top, there are links for 'Language English', 'Online Help', and 'Logout', along with the 'funkwerk' logo. The left sidebar contains a navigation menu with categories like 'System Management', 'Physical Interfaces', 'LAN', 'Wireless LAN', 'Routing', 'Local Services', 'Maintenance', 'External Reporting', and 'Monitoring'. The 'Routing' menu is expanded, showing 'Routes', 'IIAT', 'RIP', 'Load Balancing', and 'Multicast'. The 'Routes' menu is further expanded to show 'IP Routes' and 'Options'. The 'IP Routes' page is displayed, featuring a 'Route Class' section with an 'Extended Route' checkbox checked and labeled 'Enabled'. Below this is the 'Route Parameters' section with fields for 'Route Type' (Network Route), 'Destination IP Address / Netmask', 'Interface' (None), 'Network Type' (Direct), 'Local IP Address' (0.0.0.0), and 'Metric' (1). The 'Extended Route Parameters' section includes 'Source Interface' (None), 'Source IP Address' (0.0.0.0 / 0.0.0.0), 'Layer 4 Protocol' (Any), 'Source Port' (Any Port -1 to Port -1), 'Destination Port' (Any Port -1 to Port -1), 'DSCP / TOS Value' (Ignore), and 'Mode' (Dialup and wait). At the bottom of the form are 'OK' and 'Cancel' buttons.

Fig. 99: Routing -> Routes -> IP Routes-> New with Extended Route = Enabled

The Routing -> Routes -> IP Routes-> New menu consists of the following fields:

Fields in the IP Routes Route Class menu

Field	Description
Extended Route	<p>Select whether the route is to be defined with extended parameters. If the function is active, a route is created with extended routing parameters such as source interface and source IP address, as well as protocol, source and destination port, type of service (TOS) and the status of the device interface.</p> <p>The function is activated by choosing <i>Enabled</i>.</p> <p>The function is disabled by default.</p>

Fields in the IP Routes Route Parameters menu

Field	Description
Route Type	Select the type of route.

Field	Description
	<p>Possible values:</p> <ul style="list-style-type: none"> • <i>Network Route</i> (default value): Route to a network. • <i>Default Route</i> : Is used if no other suitable route is available. • <i>Host Route</i> : Route to a single host.
Destination IP Address / Netmask	<p>Only if Route Type <i>Host Route</i> or <i>Network Route</i></p> <p>Enter the IP address of the destination host.</p> <p>If Route Type = <i>Network Route</i> also enter the netmask in the second field. If no entry is made, your device uses a default netmask.</p>
Interface	If necessary, enter the interface to be used for this route.
Network Type	<p>Not for Route Type = <i>Standard Route</i></p> <p>Also select the network type.</p> <p>Possible values:</p> <ul style="list-style-type: none"> • <i>Direct</i> (default value): <ul style="list-style-type: none"> • in the LAN: You define another IP address for the interface. • in the WAN: You define a route without a transit network. • <i>Indirect</i>: <ul style="list-style-type: none"> • in the LAN: You define a gateway route. • in the WAN: You define a route with a transit network.
Local IP Address	<p>Only for Network Type = <i>Direct</i>.</p> <p>Enter the IP address of the gateway to which your device is to forward the IP packets.</p>
Gateway	<p>Only for Network Type = <i>Indirect</i>.</p> <p>Enter the IP address of the host to which your device is to forward the IP packets.</p>
Metric	Select the priority of the route.

Field	Description
	<p>The lower the value, the higher the priority of the route.</p> <p>Value range from 0 to 15, The default value is 1.</p>

Fields in the IP Routes Extended Route Parameters menu

Field	Description
Source Interface	<p>Select the interface over which the data packets are to reach the device.</p> <p>The default value is <i>None</i>.</p>
Source IP Address	<p>Enter the IP address and netmask of the source host or source network.</p>
Layer 4 Protocol	<p>Select a protocol.</p> <p>Possible values: <i>ICMP</i> , <i>TCP</i> , <i>UDP</i> , <i>GRE</i> , <i>ESP</i> , <i>AH</i> , <i>OSPF</i> , <i>L2TP</i> , <i>ANY</i> .</p> <p>The default value is <i>ANY</i>.</p>
Source Port	<p>Only if Layer 4 Protocol = <i>TCP</i> or <i>UDP</i>.</p> <p>Enter the source port.</p> <p>First select the port number range.</p> <p>Possible values:</p> <ul style="list-style-type: none"> • <i>Any</i> (default value): The route is valid for all port numbers. • <i>Single</i>: Enables the entry of a port number. • <i>Range</i>: Enables the entry of a range of port numbers. • <i>Privileged</i>: Entry of privileged port numbers: 0 ... 1023. • <i>Server</i>: Entry of server port numbers: 5000 ... 32767. • <i>Clients 1</i>: Entry of client port numbers: 1024 ... 4999. • <i>Clients 2</i>: Entry of client port numbers: 32768 ... 65535. • <i>Not privileged</i>: Entry of unprivileged port numbers: 1024 ... 65535. <p>Enter the appropriate values for the individual port or start port of a range in Port and, for a range, the end port in to Port.</p>

Field	Description
Destination Port	<p>Only if Layer 4 Protocol = <i>TCP</i> or <i>UDP</i>.</p> <p>Enter the destination port.</p> <p>First select the port number range.</p> <p>Possible values:</p> <ul style="list-style-type: none"> • <i>Any</i> (default value): The route is valid for all port numbers. • <i>Single</i>: Enables the entry of a port number. • <i>Range</i>: Enables the entry of a range of port numbers. • <i>Privileged</i>: Entry of privileged port numbers: 0 ... 1023. • <i>Server</i>: Entry of server port numbers: 5000 ... 32767. • <i>Clients 1</i>: Entry of client port numbers: 1024 ... 4999. • <i>Clients 2</i>: Entry of client port numbers: 32768 ... 65535. • <i>Not privileged</i>: Entry of unprivileged port numbers: 1024 ... 65535. <p>Enter the appropriate values for the individual port or start port of a range in Port and, for a range, the end port in to Port.</p>
DSCP / TOS Value	<p>Select the Type of Service (TOS).</p> <p>Possible values:</p> <ul style="list-style-type: none"> • <i>Ignore</i> (default value): The type of service is ignored. • <i>DSCP</i>: Relates to a Differentiated Services Code Point to RFC 3260. • <i>TOS Binary Value</i>: The TOS value is specified in binary format, e.g. 00111111. • <i>TOS Decimal Value</i>: The TOS value is specified in decimal format, e.g. 63. <p>Enter the relevant value for <i>DSCP</i>, <i>TOS Binary Value</i> and <i>TOS Decimal Value</i>.</p>
Mode	<p>Select when the interface defined in Route Parameters -> Interface is to be used.</p> <p>Possible values:</p> <ul style="list-style-type: none"> • <i>Dialup and wait</i> (default value): The route can be used if

Field	Description
	<p>the interface is "up". If the interface is "dormant", then dial and wait until the interface is "up".</p> <ul style="list-style-type: none"> • <i>Authoritative</i> : The route can always be used. • <i>Dialup and continue</i>: The route can be used if the interface is "up". If the interface is "dormant", then select and use the alternative route (rerouting) until the interface is "up". • <i>Never dialup</i>: The route can be used if the interface is "up". • <i>Always dialup</i>: The route can be used if the interface is "up". If the interface is "dormant", then dial and wait until the interface is "up". In this case, an alternative interface with a poorer metric is used for routing until the interface is "up".

9.1.2 Options

Back Route Verify

The term Back Route Verify describes a very simple but powerful function. If a check is activated for an interface, incoming data packets are only accepted over this interface if outgoing response packets are routed over the same interface. You can therefore prevent the acceptance of packets with false IP addresses - even without using filters.

bintec R1200

Language English Online Help Logout funkwerk

Save configuration

System Management

Physical Interfaces

LAN

Wireless LAN

Routing

Routes

IAT

RIP

Load Balancing

Multicast

WAN

VPN

Firewall

VoIP

Local Services

Maintenance

External Reporting

Monitoring

IP Routes Options

Back Route Verify

Mode

Enable for all interfaces

Enable for specific interfaces

Disable for all interfaces

View 20 per page Filter in None equal Go

#	Interface	Back Route Verify
1	en1-0	<input type="checkbox"/> Enabled
2	en1-4	<input type="checkbox"/> Enabled
3	sta1-0	<input type="checkbox"/> Enabled

Page: 1, Items: 1 - 3

General

Allow deleting/editing all routing entries Enabled

OK Cancel

Fig. 100: Routing -> Routes -> Options

The **Routing -> Routes -> Options** menu consists of the following fields:

Fields in the Options Return Route Checking menu

Field	Description
Mode	<p>Select how the interfaces to be activated for Back Route Verify are to be specified.</p> <p>Possible values:</p> <ul style="list-style-type: none"> • <i>Enable for all Interfaces</i>: Back Route Verify is activated for all interfaces. • <i>Enable for Specific Interfaces</i> (default value): A list of all interfaces is displayed in which Back Route Verify is only enabled for specific interfaces. • <i>Disable for all Interfaces</i>: Back Route Verify is disabled for all interfaces.
#	<p>Only for Mode = <i>Enable for specific interfaces</i></p> <p>Displays the serial number of the list entry.</p>
Interface	<p>Only for Mode = <i>Enable for Specific Interfaces</i>.</p> <p>Displays the name of the interface.</p>
Back Route Verify	<p>Only for Mode = <i>Enable for Specific Interfaces</i>.</p> <p>Select whether Back Route Verify is to be activated for this interface.</p> <p>The function is activated with <i>Enabled</i>.</p> <p>By default, the function is deactivated for all interfaces.</p>

Fields in the Options General menu

Field	Description
Allow deleting/editing all routing entries	<p>Define whether all the routes entered on your device can be edited and deleted in the Routing -> Routes -> Routes menu.</p> <p>The function is activated with <i>Enabled</i>.</p> <p>By default, the function is deactivated for all interfaces.</p>

9.2 NAT

9.2.1 NAT Interfaces

Network Address Translation (NAT) is a function on your device for defined conversion of source and destination addresses of IP packets. If NAT is activated, IP connections are still only allowed by default in one direction, outgoing (forward) (= protective function). Exceptions to the rule can be configured (in *Portforwarding* on page 229).

In the **Routing -> NAT -> NAT Interfaces** menu, a list of all NAT interfaces is shown.

The screenshot shows the web interface for a bintec R1200 device. The main content area is titled "NAT Interfaces" and "Portforwarding". A table lists the following NAT interfaces:

Interface	NAT active	Silent Deny	PPTP Passthrough	Portforwardings
LAN_EN1-0	<input type="checkbox"/>	<input type="checkbox"/>	<input type="checkbox"/>	0
LAN_EN1-4	<input type="checkbox"/>	<input type="checkbox"/>	<input type="checkbox"/>	0
LAN_STA1-0	<input type="checkbox"/>	<input type="checkbox"/>	<input type="checkbox"/>	0

Page: 1, Items: 1 - 3

Fig. 101: **Routing -> NAT -> NAT Interfaces**

For each NAT interface, you can select the options *NAT Active*, *Silent Deny* and *PPTP Passthrough*.

In addition, *Portforwardings* displays how many portforwarding rules were configured for this interface.

Options in the menu NAT Interfaces

Field	Description
NAT Active	Select whether NAT is to be activated for the interface. The function is disabled by default.

Field	Description
Silent Deny	<p>Select whether IP packets are to be silently denied by NAT. If this function is deactivated, the sender of the denied IP packet is informed by means of an ICMP or TCP RST message.</p> <p>The function is disabled by default.</p>
PPTP Passthrough	<p>Select whether the setup and operation of several simultaneous, outgoing PPTP connections from hosts in the network are also to be permitted if NAT is activated.</p> <p>The function is disabled by default.</p> <p>If PPTP Passthrough is enabled, the device itself cannot be configured as a tunnel endpoint.</p>
Portforwardings	<p>Shows the number of portforwarding rules configured in Routing -> NAT -> Portforwarding.</p>

9.2.2 Portforwarding

In the **Routing -> NAT -> Portforwarding** menu, a list of all NAT interfaces is shown for which portforwarding has been configured.

9.2.2.1 New

Choose the **New** button to set up portforwarding for other interfaces.

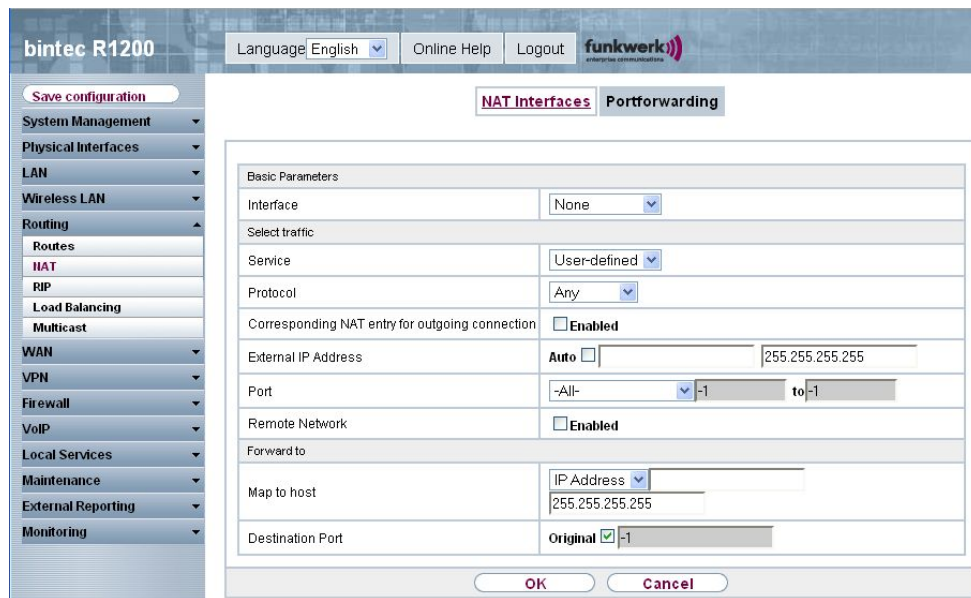

Fig. 102: Routing -> NAT ->Portforwarding -> New

The **Routing -> NAT -> Portforwarding -> New** menu consists of the following fields:

Fields in the Portforwarding Basic Parameters menu

Field	Description
Interface	Select the interface for which portforwarding is to be configured.

Fields in the Portforwarding Select traffic

Field	Description
Service	Select the service for which address mapping is defined for incoming connections. Possible values: <ul style="list-style-type: none"> • <i>User-defined</i> (default value) • <i>DNS (UDP)</i> • <i>DNS (TCP)</i> • <i>FTP</i> • <i>HTTP</i> • <i>HTTPS</i> • <i>IMAP</i>

Field	Description
	<ul style="list-style-type: none">• <i>NNTP</i>• <i>POP3</i>• <i>SMTP</i>• <i>SSH</i>• <i>TELNET</i>
Protocol	<p>Only if Service = <i>User-defined</i>.</p> <p>Select the protocol.</p> <p>Possible values:</p> <ul style="list-style-type: none">• <i>Any</i>• <i>ICMP</i>• <i>GGP</i>• <i>IP</i>• <i>TCP</i>• <i>EGP</i>• <i>IGP</i>• <i>PUP</i>• <i>Chaos</i>• <i>UDP</i>• <i>HMP</i>• <i>XNS-IDP</i>• <i>RDP</i>• <i>IPv6</i>• <i>RSVP</i>• <i>GRE</i>• <i>ESP</i>• <i>AH</i>• <i>TLSP</i>• <i>Skip</i>• <i>Kryptolan</i>• <i>ISO-IP</i>• <i>IGRP</i>

Field	Description
	<ul style="list-style-type: none"> • <i>OSPF</i> • <i>IPinIP</i> • <i>IPXinIP</i> • <i>VRRP</i> • <i>L2TP</i>
Corresponding NAT entry for outgoing connection	<p>Specify whether a NAT entry is to be created for outgoing connections for portforwarding.</p> <p>The function is activated with <i>Enabled</i>.</p> <p>The function is activated by default.</p>
External IP address	<p>Select the external host or network IP address of the selected interface.</p> <p>In default scenarios, only one external IP address is available. In this case, select the Auto option.</p> <p>The Auto option is disabled by default, so that you can enter the IP address manually.</p>
Port	<p>Only if Service = <i>User-defined</i>.</p> <p>First select whether all connections are to be permitted, or whether a certain port or port range is to be defined.</p> <p>Possible values:</p> <ul style="list-style-type: none"> • <i>All</i> (default value): No port mapping is carried out. In this case, the value <i>-1</i> is entered in the input fields. • <i>Specify Port</i> : Enables a port number to be entered. • <i>Specify Port Range</i> : Enables a port number range to be entered. <p>Now enter the original destination port or destination port range (...to...) of the incoming IP connection.</p>
Remote network	<p>Select whether IP packets are to be forwarded to a remote network.</p> <p>The function is disabled by default.</p>

Field	Description
	The function is activated with <i>Yes</i> .
Remote IP Address / Netmask	Only for Remote Network = <i>Yes</i> . Now enter the remote IP address and netmask for the remote network.

Fields in the Portforwarding Forward to menu

Field	Description
Map to host	Enter the IP address of the internal host or network. You can also select the <i>Local</i> option, in which case the port is mapped to your device.
Destination Port	Enter the new destination port of the incoming IP connection. Select whether the source port is to be used by enabling the Original option. In this case, enter the value <i>-1</i> in the port number input field. Or disable the Original option and enter a port number.

9.3 RIP

The entries in the routing table can be defined statically or the routing table can be updated constantly by dynamic exchange of routing information between several devices. This exchange is controlled by a Routing Protocol, e.g. RIP (Routing Information Protocol). By default, about every 30 seconds (this value can be changed in **Update Timer**), a device sends messages to remote networks using information from its own current routing table. The complete routing table is always exchanged in this process. If triggered RIP is used, information is only exchanged if the routing information has changed. In this case, only the changed information is sent.

Observing the information sent by other devices enables new routes and shorter paths for existing routes to be saved in the routing table. As intermediate routes between networks can become unreachable, RIP removes routes that are older than 5 minutes (i.e. routes not verified in the last 300 seconds - **Garbage Collection Timer** + **Route Timeout**). Routes learnt with triggered RIP are not deleted.

Your device supports both version 1 and version 2 of RIP, either individually or together.

9.3.1 RIP Interfaces

In the **Routing -> RIP -> RIP Interfaces** menu, a list of all RIP interfaces is shown.

The screenshot shows the web interface for a bintec R1200 device. The top navigation bar includes 'Language English', 'Online Help', 'Logout', and the 'funkwerk' logo. The left sidebar contains a tree view with categories like 'System Management', 'Physical Interfaces', 'LAN', 'Wireless LAN', 'Routing', 'Routes', 'HAT', 'RIP', 'Load Balancing', 'Multicast', 'WAN', 'VPN', 'Firewall', 'VoIP', 'Local Services', 'Maintenance', 'External Reporting', and 'Monitoring'. The 'RIP' menu item is selected, leading to the 'RIP Interfaces' page. This page has three tabs: 'RIP Interfaces', 'RIP Filter', and 'RIP Options'. Below the tabs is a table with the following data:

#	Interface	Send Version	Receive Version	Route Announce
1	en1-0	None	None	Up only
2	en1-4	None	None	Up only
3	sta1-0	None	None	Up only

At the bottom of the table, it says 'Page: 1, Items: 1 - 3'. Above the table, there are controls for 'View 20 per page', 'Filter in None', and 'equal'.

Fig. 103: Routing -> RIP ->RIP Interfaces

9.3.1.1 Edit

For each RIP interface, you can, in the  menu, select the options *Send Version*, *Re-*
ceive Version and *Route Announce*.

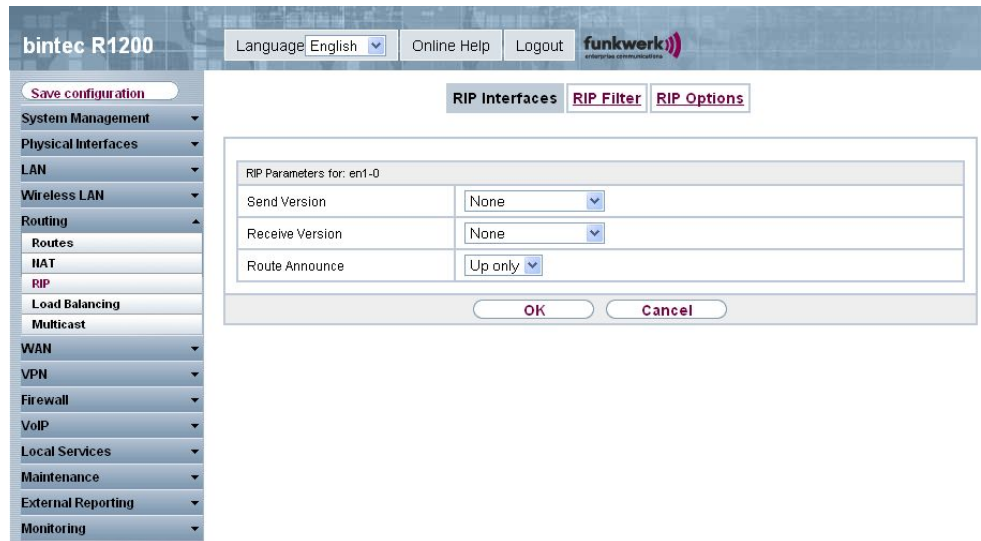

Fig. 104: Routing -> RIP ->RIP Interfaces->

The **Routing -> RIP -> RIP Interfaces->** menu consists of the following fields:

Fields in the RIP Parameters for: <Interface> menu

Field	Description
Send Version	<p>Decide whether routes are to be propagated via RIP and if so, select the RIP version for sending RIP packets over the interface in send direction.</p> <p>Possible values:</p> <ul style="list-style-type: none"> • <i>None</i> (default value): RIP is not enabled. • <i>RIP V1</i>: Enables sending and receiving of version 1 RIP packets. • <i>RIP V2</i>: Enables sending and receiving of version 2 RIP packets. • <i>RIP V1/V2</i>: Enables sending and receiving of both version 1 and version 2 RIP packets. • <i>RIP V2 Multicast</i>: For sending RIP V2 messages over the multicast address 224.0.0.9. • <i>RIP V1 Triggered</i>: RIP V1 messages are sent, received and processed as per RFC 2091 (triggered RIP). • <i>RIP V2 Triggered</i>: RIP V2 messages are sent, received and processed as per RFC 2091 (triggered RIP).

Field	Description
Receive Version	<p>Decide whether routes are to be imported via RIP and if so, select the RIP version for receiving RIP packets over the interface in receive direction.</p> <p>Possible values:</p> <ul style="list-style-type: none"> • <i>None</i> (default value): RIP is not enabled. • <i>RIP V1</i>: Enables sending and receiving of version 1 RIP packets. • <i>RIP V2</i>: Enables sending and receiving of version 2 RIP packets. • <i>RIP V1/V2</i>: Enables sending and receiving of both version 1 and version 2 RIP packets. • <i>RIP V1 Triggered</i>: RIP V1 messages are sent, received and processed as per RFC 2091 (triggered RIP). • <i>RIP V2 Triggered</i>: RIP V2 messages are sent, received and processed as per RFC 2091 (triggered RIP).
Route Announce	<p>Select this option if you want to set the time at which any activated routing protocols (e.g. RIP) are to propagate the IP routes defined for this interface.</p> <p>Note: This setting does not affect the interface-specific RIP configuration mentioned above.</p> <p>Possible values:</p> <ul style="list-style-type: none"> • <i>Up Only</i> (default value): Routes are only propagated if the interface status is up. • <i>Always</i>: Routes are always propagated independent of operational status.

9.3.2 RIP Filter

In this menu, you can specify exactly which routes are to be exported or imported.

You can use the following strategies for this:

- You explicitly deactivate the import or export of certain routes. The import or export of all other routes that are not listed is still allowed.
- You explicitly activate the import or export of certain routes. In this case, you must also

explicitly deactivate the import or export of all other routes. You can do this using a filter for **IP Address** = no entry (this corresponds to the IP address 0.0.0.0) with **Netmask** = no entry (this corresponds to the netmask 0.0.0.0). To make sure this filter is used last, it must be placed at the lowest position.

You configure a filter for a default route with the following values:

- **IP Address** = no entry (this corresponds to the IP address 0.0.0.0) with **Netmask** = 255.255.255.255

In the **Routing -> RIP -> RIP Filters** menu, a list of all RIP filters is shown.

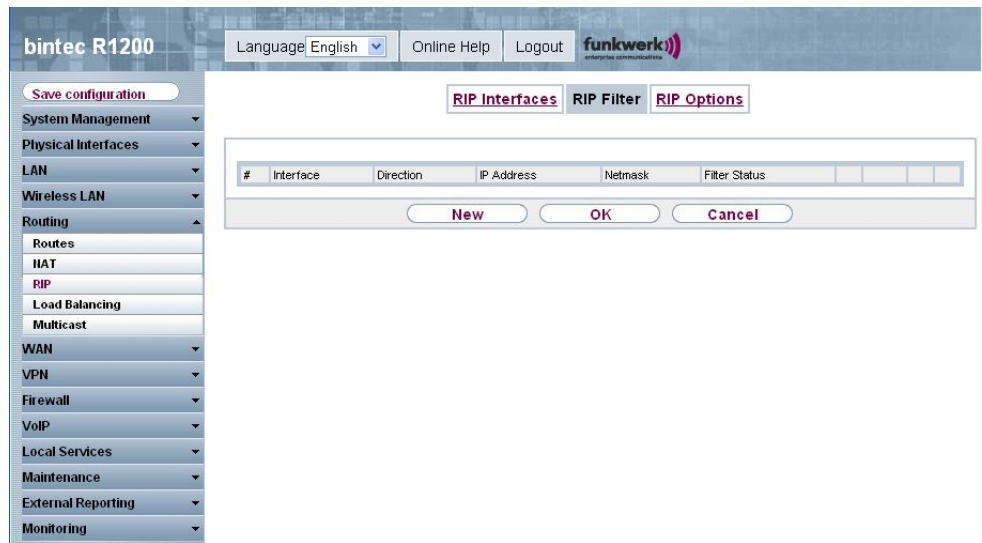



Fig. 105: **Routing -> RIP ->RIP Filters**

You can use the  button to insert another filter above the list entry. The configuration menu for creating a new window opens.

You can use the  button to move the list entry. A dialog box opens, in which you can select the position to which the filter is to be moved.

9.3.2.1 New

Choose the **New** button to set up more RIP filters.

The screenshot shows the bintec R1200 web interface. On the left is a navigation menu with categories like System Management, Physical Interfaces, LAN, Wireless LAN, Routing (selected), and others. The 'Routing' menu is expanded to show 'RIP' (highlighted in red). The main content area has three tabs: 'RIP Interfaces', 'RIP Filter' (selected), and 'RIP Options'. The 'RIP Filter' tab displays a 'Basic Parameters' form with the following fields:

- Interface: A dropdown menu currently set to 'None'.
- IP Address / Netmask: Two input fields separated by a slash.
- Direction: Radio buttons for 'Import' (selected) and 'Export'.
- Metric Offset for Active Interfaces: A dropdown menu set to '0'.
- Metric Offset for Inactive Interfaces: A dropdown menu set to '0'.

At the bottom of the form are 'OK' and 'Cancel' buttons.

Fig. 106: Routing -> RIP ->RIP Filters-> New

The **Routing -> RIP -> RIP Filter-> New** menu consists of the following fields:

Fields in the RIP Filter Basic Parameters menu

Field	Description
Interface	Select the interface to which the rule to be configured applies.
IP Address/Netmask	Enter the IP address and netmask to which the rule is to be applied. This address can be in the LAN or WAN. The rules for incoming and outgoing RIP packets (import or export) for the same IP address must be separately configured. You can enter individual host addresses or network addresses.
Direction	Select whether the filter applies to the export or import of routes. Possible values: <ul style="list-style-type: none"> <i>Import</i> (default value) <i>Export</i>
Metric Offset for Active Interfaces	Select the value to be added to the route metric if the status of the interface is "up". During export, the value is added to the exported metric if the interface status is "up".

Field	Description
	<p>Possible values are -16 to 16.</p> <p>The default value is 0.</p>
Metric Offset for Inactive Interfaces	<p>Select the value to be added to the route metric if the status of the interface is "dormant". During export, the value is added to the exported metric if the interface status is "dormant".</p> <p>Possible values are -16 to 16.</p> <p>The default value is 0.</p>

9.3.3 RIP Options

The screenshot shows the configuration interface for the bintec R1200. The left sidebar contains a navigation menu with categories like System Management, Physical Interfaces, LAN, Wireless LAN, Routing, WAN, VPN, Firewall, VoIP, Local Services, Maintenance, External Reporting, and Monitoring. The 'Routing' section is expanded to show 'RIP'. The main content area has three tabs: 'RIP Interfaces', 'RIP Filter', and 'RIP Options'. The 'RIP Options' tab is selected, displaying the 'Global RIP Parameters' section. This section includes several configuration items: 'RIP UDP Port' set to 520, 'Default Route Distribution' checked (Enabled), 'Poisoned Reverse' unchecked (Disabled), 'RFC 2453 Variable Timer' checked (Enabled), and 'RFC 2091 Variable Timer' unchecked (Disabled). Below these is a 'Timer for RIP V2 (RFC 2453)' section with three sub-parameters: 'Update Timer' at 30 seconds, 'Route Timeout' at 180 seconds, and 'Garbage Collection Timer' at 120 seconds. At the bottom of the configuration area are 'OK' and 'Cancel' buttons.

Fig. 107: Routing -> RIP -> RIP Options

The **Routing -> RIP -> RIP Options** menu consists of the following fields:

Fields in the RIP Options Global RIP Parameters menu

Field	Description
RIP UDP Port	The setting option UDP Port, which is used for sending and receiving RIP updates, is only for test purposes. If the setting is changed, this can mean that your device sends and listens at a port that no other devices use. The default value 520 should be

Field	Description
	retained.
Default Route Distribution	<p>Select whether the default route of your device is to be propagated via RIP updates.</p> <p>The function is activated with <i>Enabled</i>.</p> <p>The function is enabled by default.</p>
Poisoned Reverse	<p>Select the procedure for preventing routing loops.</p> <p>With standard RIP, the routes learnt are propagated over all interfaces with RIP SEND activated. With Poisoned Reverse, however, your device propagates over the interface over which it learnt the routes, with the metric (Next Hop Count) 16 (=“Network is not reachable”).</p> <p>The function is activated with <i>Enabled</i>.</p> <p>The function is disabled by default.</p>
RFC 2453 Variable Timer	<p>For the timers described in RFC 2453, select whether the same values that you can configure in the Timer for RIP V2 (RFC 2453) menu.</p> <p>The function is activated with <i>Enabled</i>.</p> <p>The function is enabled by default.</p> <p>If you deactivate the function, the times defined in RFC are retained for the timeouts.</p>
RFC 2091 Variable Timer	<p>For the timers described in RFC 2091, select whether the same values that you can configure in the Timer for Triggered RIP (RFC 2091) menu.</p> <p>The function is activated with <i>Enabled</i>.</p> <p>The function is disabled by default.</p> <p>If the function is not activated, the times defined in RFC are retained for the timeouts.</p>

Fields in the RIP Options Timer for RIP V2 (RFC 2453) menu

Field	Description
Update Timer	<p>Only for RFC 2453 Variable Timer = Enabled</p> <p>An RIP update is sent on expiry of this period of time.</p> <p>The default value is 30 (seconds).</p>
Route Timeout	<p>Only for RFC 2453 Variable Timer = Enabled</p> <p>After the last update of a route, the route time is active.</p> <p>After timeout, the route is deactivated and the Garbage Collection Timer is started.</p> <p>The default value is 180 (seconds).</p>
Garbage Collection Timer	<p>Only for RFC 2453 Variable Timer = Enabled</p> <p>The Garbage Collection Timer is started as soon as the route timeout has expired.</p> <p>After this timeout, the invalid route is deleted from the IPROUTETABLE if no update is carried out for the route.</p> <p>The default value is 120 (seconds).</p>

Fields in the RIP Options Timer for Triggered RIP (RFC 2091) menu

Field	Description
Hold Down Timer	<p>Only for RFC 2091 Variable Timer = Enabled</p> <p>The hold down timer is activated as soon as your device receives an unreachable route (metric 16). The route may be deleted once this period has elapsed.</p> <p>The default value is 120 (seconds).</p>
Retransmission Timer	<p>Only for RFC 2091 Variable Timer = Enabled</p> <p>After this timeout, update request or update response packets are sent again until an update flush or update acknowledge packet arrives.</p> <p>The default value is 5 (seconds).</p>

9.4 Load Balancing

9.4.1 Load Balancing Groups

The increasing amount of data traffic over the Internet means it is necessary to send data over different interfaces to increase the total bandwidth available. IP load balancing enables the controlled distribution of traffic within a particular group of interfaces according to the following principles:

- In contrast to Multilink PPP-based solutions, load balancing also functions with accounts with different providers.
- Session-based load balancing is achieved.
- Related (dependent) sessions are always routed over the same interface.
- A decision on distribution is only made for outgoing sessions.

In the **Routing -> Load Balancing -> Load Balancing Groups** menu a list of all configured load balancing groups is shown.

9.4.1.1 New

Choose the **New** button to set up new groups.

The screenshot shows the web interface for a bintec R1200 device. The top navigation bar includes 'Language English', 'Online Help', 'Logout', and the 'funkwerk' logo. The left sidebar menu is expanded to 'Routing', with 'Load Balancing' highlighted. The main content area is titled 'Load Balancing Groups' and contains a form for creating a new group. The form has the following fields:

- Basic Parameters**
 - Group Description: [Text input field]
 - Distribution Policy: [Dropdown menu, selected: Session-Round-Robin]
 - Distribution Mode: [Checkbox, checked]
- Interface Selection for Distribution**
 - Interface: [Text input field]
 - Distribution Ratio: [Text input field]

At the bottom of the form, there is an 'Add' button and three buttons: 'OK', 'Cancel', and 'Back'.

Fig. 108: **Routing -> Load Sharing ->Load Sharing Groups -> New**

The **Routing -> Load Balancing ->Load Balancing Groups -> New** menu consists of the

following fields:

Fields in the Load Balancing Groups Basic Parameters menu

Field	Description
Group Description	Enter the desired description of the interface group.
Distribution Policy	<p>Select the way the data traffic is to be distributed to the interfaces configured for the group.</p> <p>Possible values:</p> <ul style="list-style-type: none"> • <i>Session-Round-Robin</i> (default value): A newly added session is assigned to one of the group interfaces according to the percentage assignment of sessions to the interfaces. The number of sessions is decisive. • <i>Load-dependent Bandwidth</i>: A newly added session is assigned to one of the group interfaces according to the share of the total data rate handled by the interfaces. The current data rate based on the data traffic is decisive in both the send and receive direction.
Consider	<p>Only for Distribution Policy = <i>Load-dependent Bandwidth</i></p> <p>Choose the direction in which the current data rate is to be considered.</p> <p>Options:</p> <ul style="list-style-type: none"> • <i>Download</i>: Only the data rate in the receive direction is considered. • <i>Upload</i>: Only the data rate in the send direction is considered. <p>The <i>Download</i> and <i>Upload</i> are deactivated by default.</p>
Distribution Mode	<p>Select the state the interfaces in the group may have if they are to be included in load balancing.</p> <ul style="list-style-type: none"> • <i>Always</i> (default value): Interfaces in dormant state are also included. • <i>Only use active interfaces</i>: Only interfaces in up state are included.

In the **Interface Selection for Load Balancing** area, you add and configure interfaces that match the current group context. You can also delete interfaces.

Use **Add** to create entries.

Fields in the Load Balancing Groups Interface Selection for Distribution menu

Field	Description
Interface	Select the interfaces that are to belong to the group from the available interfaces.
Distribution Ratio	<p>Enter the percentage of the data traffic to be assigned to an interface.</p> <p>The meaning differs according to the Distribution Policy used:</p> <ul style="list-style-type: none"> • Based on the number of sessions to be distributed for <i>Session-Round-Robin</i>. • For <i>Bandwidth Load Dependent</i> the data rate is the decisive factor.

9.5 Multicast

What is multicasting?

Many new communication technologies are based on communication from one sender to several recipients. Therefore, modern telecommunication systems such as voice over IP or video and audio streaming (e.g. IPTV or Webradio) focus on reducing data traffic, e.g. by offering TriplePlay (voice, video, data). Multicast is a cost-effective solution for effective use of bandwidth because the sender of the data packet, which can be received by several recipients, only needs to send the packet once. The packet is sent to a virtual address defined as a multicast group. Interested recipients log in to these groups.

Other areas of use

One classic area in which multicast is used is for conferences (audio/video) with several recipients. The most well-known are probably the MBone Multimedia Audio Tool (VAT), Video Conferencing Tool (VIC) and Whiteboard (WB). VAT can be used to hold audio conferences. All participants are displayed in a window and the speaker(s) are indicated by a black box. Other areas of use are of particular interest to companies. Here, multicasting makes it possible to synchronise the databases of several servers, which is valuable for multinationals or even companies with just a few locations.

Address range for multicast

For IPv4 the IP addresses 224.0.0.0 to 239.255.255.255 (224.0.0.0/4) are reserved for multicast in the class D network. An IP address from this range represents a multicast group to which several recipients can log in. The multicast router then forwards the required packets to all subnets with logged in recipients.

Multicast basics

Multicast is connectionless, which means that any trouble-shooting or flow control needs to be guaranteed at application level.

At transport level, UDP is used almost exclusively, as, in contrast to TCP, it is not based on a point-to-point connection.

At IP level, the main difference is therefore that the destination address does not address a dedicated host, but rather a group, i.e. during the routing of multicast packets, the decisive factor is whether a recipient is in a logged-in subnet.

In the local network, all hosts are required to accept all multicast packets. For Ethernet or FDD, this is based on MAC mapping, where the group address is encoded into the destination MAC address. For routing between several networks, the routers first need to make themselves known to all potential recipients in the subnet. This is achieved by means of Membership Management protocols such as IGMP for IPv4 and MLP for IPv6.

Membership Management protocol

In IPv4, IGMP (Internet Group Management Protocol) is a protocol that hosts can use to provide the router with multicast membership information. IP addresses of the class D address range are used for addressing. An IP address in this class represents a group. A sender (e.g. Internet radio) sends data to this group. The addresses (IP) of the various senders within a group are called the source (addresses). Several senders (with different IP addresses) can therefore transmit to the same multicast group, leading to a 1-to-n relationship between groups and source addresses. This information is forwarded to the router by means of reports. In the case of incoming multicast data traffic, a router can use this information to decide whether a host in its subnet wants to receive it. Your device supports the current version IGMP V3, which is upwardly compatible, which means that both V3 and V1/V2 hosts can be managed.

Your device supports the following multicast mechanisms:

- **Forwarding:** This relates to static forwarding, i.e. incoming data traffic for a group is forwarded in all cases. This is a useful option if multicast data traffic is to be permanently forwarded.
- **IGMP:** IGMP is used to gather information about the potential recipients in a subnet. In the case of a hop, incoming multicast data traffic can thus be selected.



Tip

With multicast, the focus is on excluding data traffic from unwanted multicast groups. Note that if forwarding is combined with IGMP, the packets can be forwarded to the groups specified in the forwarding request.

9.5.1 Forwarding

In this menu, you specify which multicast groups are always forwarded between the interfaces of your device.

9.5.1.1 New

Choose the **New** button to create forwarding rules for new multicast groups.

The screenshot shows the web interface for a bintec R1200 device. The top navigation bar includes 'Language English', 'Online Help', 'Logout', and the 'funkwerk' logo. The left sidebar has a 'Save configuration' button and a menu with categories like System Management, Physical Interfaces, LAN, Wireless LAN, Routing (expanded to show Routes, IAT, RIP, Load Balancing, and Multicast), WAN, VPN, Firewall, VoIP, Local Services, Maintenance, External Reporting, and Monitoring. The main content area is titled 'Forwarding' and has sub-tabs for 'IGMP' and 'Options'. The 'Forwarding' sub-tab is active, showing a form for 'Basic Parameters'. The form has four fields: 'All Multicast Groups' with an 'Enabled' checkbox, 'Multicast Group Address' with an empty text input, 'Source Interface' with a dropdown menu set to 'None', and 'Destination Interface' with a dropdown menu set to 'None'. At the bottom of the form are 'OK' and 'Cancel' buttons.

Fig. 109: Routing -> Multicast -> Forwarding -> /New

The Routing -> Multicast -> Forward -> /New menu consists of the following fields:

Fields in the Forward Basic Parameters menu

Field	Description
All Multicast Groups	Select whether all multicast groups, i.e. the complete multicast address range 224.0.0.0/4, are to be forwarded from the defined

Field	Description
	<p>Source Interface to the defined Destination Interface To do this, check Enabled</p> <p>Disable the option if you only want to forward one defined multicast group to a particular interface.</p> <p>The option is deactivated by default.</p>
Multicast Group Address	<p>Only for All Multicast-Groups = <i>disabled</i></p> <p>Enter here the address of the multicast group you want to forward from a defined Source Interface to a defined Destination Interface</p>
Source Interface	Select the interface on your device to which the selected multicast group is sent.
Destination Interface	Select the interface on your device to which the selected multicast group is to be forwarded.

9.5.2 IGMP

IGMP (Internet Group Management Protocol, see RFC 3376) is used to signal the information about group (membership) in a subnet. As a result, only the packets explicitly wanted by a host enter the subnet.

Special mechanisms ensure that the requirements of the individual clients are taken into consideration. At the moment there are three versions of IGMP (V1 - V3); most current systems use V3, and less often V2.

Two packet types play a central role in IGMP: queries and reports.

Queries are only transmitted from a router. If several IGMP routers exist in a network, the router with the lowest IP address is the "querier". We differentiate here between a general query (sent to 224.0.0.1), a group-specific query (sent to a group address) and the group-and-source-specific query (sent to a specific group address). Reports are only sent by hosts to respond to queries.

In this menu, you configure the interfaces on which IGMP is to be enabled.

9.5.2.1 New

Choose the **New** button to configure IGMP on other interfaces.

The screenshot displays the configuration page for IGMP on a bintec R1200 device. The left sidebar contains a navigation tree with 'Routing' expanded to 'Multicast' and 'IGMP' selected. The main panel shows the 'IGMP Settings' form with the following fields:

- Interface:** A dropdown menu currently set to 'None'.
- Query Interval:** A text input field containing '125', followed by the unit 'Seconds'.
- Maximum Response Time:** A text input field containing '10', followed by the unit 'Seconds'.
- Robustness:** A dropdown menu set to '2'.
- Last Member Query Interval:** A text input field containing '1', followed by the unit 'Seconds'.
- IGMP State Limit:** A text input field containing '0', followed by the unit 'Messages per Second'.
- Mode:** Radio buttons for 'Host only' and 'Host and Routing', with 'Host and Routing' selected.

Below the main form is the 'Advanced Settings' section:

- IGMP Proxy:** A checkbox labeled 'Enabled' which is checked.
- Proxy Interface:** A dropdown menu set to 'Select one'.

At the bottom of the form are 'OK' and 'Cancel' buttons.

Fig. 110: Routing -> Multicast -> IGMP -> /New

The **Routing -> Multicast -> IGMP -> /New** menu consists of the following fields:

Fields in the IGMP IGMP Settings menu

Field	Description
Interface	Select the interface on which IGMP is to be enabled, i.e. queries are sent and responses are accepted.
Query Interval	Enter the interval in seconds in which IGMP queries are to be sent. Possible values are 0 to 600. The default value is 125.
Maximum Response Time	For the sending of queries, enter the time interval in seconds within which hosts must respond. The hosts randomly select a time delay from this interval before sending the response. This spreads the load in networks with several hosts, improving performance. Possible values are 0 to 100. The default value is 100.

Field	Description
Robustness	<p>Select the multiplier for controlling the timer values. A higher value can e.g. compensate for packet loss in a network susceptible to loss. If the value is too high, however, the time between logging off and stopping of the data traffic can be increased (leave latency).</p> <p>Possible values are 2 to 8.</p> <p>The default value is 2.</p>
Last Member Query Interval	<p>Define the time after a query for which the router waits for an answer.</p> <p>If you shorten the interval, it will be more quickly detected that the last member has left a group so that no more packets for this group should be forwarded to this interface.</p>
Maximum number of IGMP status messages	<p>Limit the number of reports/queries per second for the selected interface.</p>
Mode	<p>Specify whether the interface defined here only works in host mode or in both host mode and routing mode.</p> <p>Possible values:</p> <ul style="list-style-type: none"> • <i>Host and Routing</i> (default value): The interface is operated in routing mode and in host mode. • <i>Host only</i>: The interface is only operated in host mode.

IGMP Proxy

IGMP Proxy enables you to simulate several locally connected interfaces as a subnet to an adjacent router. Queries coming in to the IGMP Proxy interface are forwarded to the local subnets. Local reports are forwarded on the IPGM Proxy interface.

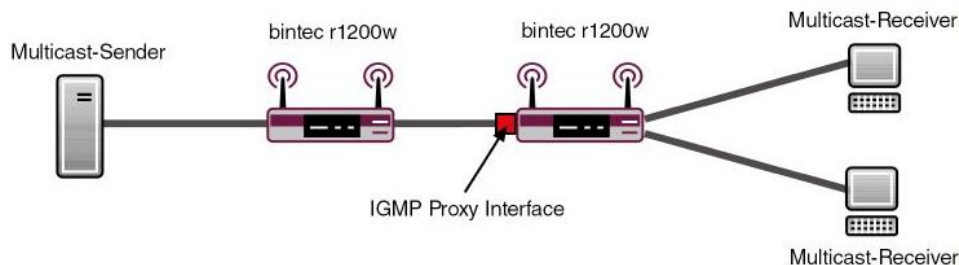

Fig. 111: IGMP Proxy

The **Advanced Settings** menu consists of the following fields:

Fields in the Advanced Settings menu

Field	Description
IGMP Proxy	Select whether your device is to forward the hosts' IGMP messages in the subnet via its defined Proxy Interface .
Proxy Interface	Select the interface on your device via which queries are to be received and collected.

9.5.3 Options

In this menu, you can enable and disable IGMP on your system. You can also define whether IGMP is to be used in compatibility mode or only IGMP V3 hosts are to be accepted.

Fig. 112: Routing -> Multicast -> Options

The **Routing -> Multicast -> Options** menu consists of the following fields:

Fields in the Options Basic Settings menu

Field	Description
IGMP Status	<p>Select the IGMP status.</p> <p>Possible values:</p> <ul style="list-style-type: none"> • <i>Auto</i>: Multicast is activated automatically for hosts if the hosts open applications that use multicast. • <i>Active</i>: Multicast is always on. • <i>Inactive</i> (default value): Multicast is always off.
Mode	<p>Only for IGMP Status = <i>Up</i></p> <p>or <i>Auto</i></p> <p>Select Multicast Mode.</p> <p>Possible values:</p> <ul style="list-style-type: none"> • <i>Compatibility Mode</i> (default value): The router uses IGMP version 3. If it notices a lower version in the network, it uses the lowest version it could detect. • <i>Version 3 only</i>: Only IGMP version 3 is used.

Field	Description
Maximum Groups	Enter the maximum number of groups to be permitted, both internally and in reports.
Maximum Sources	Enter the maximum number of sources that are specified in version 3 reports and the maximum number of internally managed sources per group.
IGMP State Limit	Enter the maximum permitted total number of incoming queries and reports per second.

Chapter 10 WAN

10.1 Internet + Dialup

In this menu, you can set up Internet access or dialup connections.

To enable your device to set up connections to networks or hosts outside your LAN, you must configure the partners you want to connect to on your device. This applies to outgoing connections (your device dials its WAN partner) and incoming connections (a remote partner dials the number of your device).

If you want to set up Internet access, you must set up a connection to your Internet Service Provider (ISP). For broadband Internet access, your device provides the PPP-over-Ethernet (PPPoE), PPP-over-PPTP and PPP-over-ATM (PPPoA) protocols. You can also configure Internet access over ISDN.



Note





Note your provider's instructions.

Dialin connections over ISDN are used to establish a connection to networks or hosts outside your LANs.

All the entered connections are displayed in the corresponding list, which contains the **Description**, the **User Name**, the **Authentication** and the current **Status**.

The **Status** field can take the following values:

Possible values for Status:

Field	Description
	connected
	not connected (dialup connection); connection setup possible
	not connected (e.g. because of an error during setup of an outgoing connection, a renewed attempt is only possible after a specified number of seconds)
	administratively set to down (deactivated); connection setup not possible for leased lines:

Authentication

When a call is received, the calling party number is always sent over the ISDN D-channel. This number enables your device to identify the caller (CLID), provided the caller is entered on your device. After identification with CLID, your device can additionally carry out PPP authentication with the connection partner before it accepts the call. Your device needs the necessary data for this, which you should enter here. First establish the type of authentication process that should be performed, then enter a common password and two codes. You get this information, for example, from your Internet Service Provider (ISP) or the system administrator at your head office. If the data you entered on your device is the same as the caller's data, the call is accepted. The call is rejected if the data is not the same.

Default Route

With a default route, all data is automatically forwarded to one connection if no other suitable route is available. If you set up access to the Internet, you must configure the route to your Internet Service Provider (ISP) as a default route. If, for example, you configure a corporate network connection, only enter the route to the head office or branch office as a default route if you do not configure Internet access over your device. If, for example, you configure both Internet access and a corporate network connection, enter a default route to the ISP and a network route to the head office. You can enter several default routes on your device, but only one default route can be active at any one time. If you enter several default routes, you should make sure the values for **Metric** are different.

Activating NAT

With Network Address Translation (NAT), you conceal your whole network to the outside world behind one IP address. You should certainly do this for your connection to the Internet Service Provider (ISP).

Only outgoing sessions are allowed initially if NAT is activated. To allow certain connections from outside to hosts within the LAN, these must be explicitly defined and admitted.

Callback

The callback mechanism can be used for every connection to obtain additional security regarding the connection partner or to clearly allocate the costs of connections. A connection is not set up until the calling party has been clearly identified by calling back. Your device can answer an incoming call with a callback or request a callback from a connection partner. Identification can be based on the calling party number or PAP/CHAP/MS-CHAP authentication. Identification is made in the former case without call acceptance, as the calling party number is transferred over the ISDN D-channel, and in the latter case with call ac-

ceptance.

Connection Idle Timeout

The connection idle timeout is determined in order to clear the connection automatically if it is not being used, i.e. if data is no longer being sent, to help you save costs.

Block after Connection Failure

You use this function to set up a waiting time for outgoing connection attempts after which your device's connection attempt is regarded as having failed.

Channel Bundling

Your device supports dynamic and static channel bundling for dialup connections. Only one B channel is initially opened when a connection is set up.

Dynamic

Dynamic channel bundling means that your device connects other ISDN B channels to increase the throughput for connections if this is required, e.g. for large data rates. If the amount of data traffic drops, the additional B channels are closed again.

Static

In static channel bundling, you specify right from the start how many B channels your device is to use for connections, regardless of the transferred data rate.

Channel bundling can only be used for ISDN connections for a bandwidth increase or as a backup. If devices from other manufacturers are to be used at the far end, ensure that these support dynamic channel bundling for a bandwidth increase or as a backup.

10.1.1 PPPoE

In the **WAN -> Internet + Dialup -> PPPoE** menu, a list of all PPPoE interfaces is shown.

PPP over Ethernet (PPPoE) is the use of the Point-to-Point Protocol (PPP) network protocol over an Ethernet connection. Today, PPPoE is used for ADSL connections in Germany. In Austria, the Point To Point Tunnelling Protocol (PPTP) was originally used for ADSL access. However, PPPoE is now offered here too by some providers.

10.1.1.1 New

Choose the **New** button to set up new PPPoE interfaces.

The screenshot shows the configuration interface for a bintec R1200 device. The left sidebar contains a navigation menu with categories like System Management, Physical Interfaces, LAN, Wireless LAN, Routing, WAN, VPN, Firewall, VoIP, Local Services, Maintenance, External Reporting, and Monitoring. The 'WAN' section is expanded to show 'Internet + Dialup', 'Leased Line', and 'Real Time Jitter Control'. The 'Internet + Dialup' section is further expanded to show 'PPPoE', 'PPTP', 'ISDN', 'GPRS/UMTS', 'AUX', and 'IP Pools'. The 'PPPoE' configuration page is displayed, featuring a 'Basic Parameters' section with fields for Description, PPPoE Mode (Standard selected), PPPoE Ethernet Interface, User Name, Password, Always on (checkbox), Connection Idle Timeout (300 seconds), IP Address Mode (Get IP Address selected), Default Route (checkbox), and Create NAT Policy (checkbox). Below this is an 'Advanced Settings' section with fields for Block after connection failure for (60 seconds), Maximum Number of Dialup Retries (5), Authentication (PAP), DNS Negotiation (checkbox), Prioritize TCP ACK Packets (checkbox), and LCP Alive Check (checkbox). At the bottom, there are 'OK' and 'Cancel' buttons.

Fig. 113: WAN -> Internet + Dialup -> PPPoE -> New

The WAN -> Internet + Dialup -> PPPoE-> New menu consists of the following fields:

Fields in the PPPoE Basic Parameters menu

Field	Description
Description	Enter a name to uniquely identify the PPPoE partner. The first character in this field must not be a number and no special characters or umlauts must be used either.
PPPoE Mode	Select whether you want to use a standard Internet connection over PPPoE (<i>Standard</i>) or your Internet access is to be set up over several interfaces (<i>Multilink</i>). If you choose <i>Mul-</i>

Field	Description
	<p><i>tilink</i>, you can connect several DSL connections from a provider over PPP as a static bundle in order to obtain more bandwidth. Each of these DSL connections should use a separate Ethernet connection for this. At the moment, many providers are still in the process of preparing the PPPoE Multilink function.</p> <p>For PPPoE Multilink, we recommend using your device's Ethernet switch in Split-Port mode and to use a separate Ethernet interface e.g. <i>en1-1</i>, <i>en1-2</i> for each PPPoE connection.</p> <p>If you also want to use an external modem for PPPoE Multilink, you must run your device's Ethernet switch in Split-Port mode.</p>
PPPoE Ethernet Interface	<p>Only if PPPoE Mode= <i>Standard</i></p> <p>Select the Ethernet interface specified for a standard PPPoE connection.</p> <p>If you want to use an external DSL modem, select the Ethernet port to which the modem is connected.</p> <p>When using the internal DSL modem, select here the EthoA interface configured in Physical Interfaces-> ATM-> Profiles-> New.</p> <p>The default value is <i>Not specified</i>.</p>
PPPoE Interfaces for Multilink	<p>Only if PPPoE Mode= <i>Multilink</i></p> <p>Select the interfaces you want to use for your Internet connection. Click the Add button to create new entries.</p>
User name	Enter the user name.
Password	Enter the password.
Always on	<p>Select whether the interface should always be activated.</p> <p>The function is activated with <i>Enabled</i>.</p> <p>The function is disabled by default.</p> <p>Only activate this option if you have Internet access with a flat-rate charge.</p>

Field	Description
Connection Idle Timeout	<p>Only if Always enabled (flatrate mode) is disabled.</p> <p>Enter the idle time in seconds for static short hold. The static short hold setting determines how many seconds should pass between sending the last traffic data packet and clearing the connection.</p> <p>Possible values are <i>0</i> to <i>3600</i> (seconds). <i>0</i> deactivates the short hold.</p> <p>The default value is <i>300</i>.</p> <p>Example: <i>10</i> for FTP transmission, <i>20</i> for LAN-to-LAN transmission, <i>90</i> for Internet connections.</p>

Fields in the PPPoEIP Mode and Routes menu

Field	Description
IP Address Mode	<p>Select whether your device is to be assigned a static IP address or whether it should be assigned this dynamically.</p> <p>Possible values:</p> <ul style="list-style-type: none"> • <i>Get IP Address</i> (default value): Your device is dynamically assigned an IP address. • <i>Static</i>: You enter a static IP address.
Default Route	<p>Select whether the route to this connection partner is to be defined as the default route.</p> <p>The function is activated with <i>Enabled</i>.</p> <p>The function is enabled by default.</p>
Create NAT Policy	<p>Specify whether Network Address Translation (NAT) is to be activated.</p> <p>The function is activated with <i>Enabled</i>.</p> <p>The function is enabled by default.</p>
Local IP Address	<p>Only if IP Address Mode = <i>Static</i></p> <p>Enter the static IP address of the connection partner.</p>

Field	Description
Route Entries	<p>Only if IP Address Mode = <i>Static</i></p> <p>Define other routing entries for this connection partner.</p> <p>Add a new entry with Add.</p> <ul style="list-style-type: none"> • <i>Remote IP Address</i>: IP address of the destination host or network. • <i>Netmask</i>: Netmask of Remote IP Address. If no entry is made, your device uses a default netmask. • <i>Metric</i>: The lower the value, the higher the priority of the route (possible values 0... 15). The default value is 1.

The **Advanced Settings** menu consists of the following fields:

Fields in the Advanced Settings menu

Field	Description
Block after connection failure for	<p>Enter the wait time in seconds before the device should try again after an attempt to set up a connection has failed. The default value is 60.</p>
Maximum Number of Dialup Retries	<p>Enter the number of unsuccessful attempts to setup a connection before the interface is blocked.</p> <p>Possible values are 0 to 100.</p> <p>The default value is 5.</p>
Authentication	<p>Select the authentication protocol for this connection partner. Select the authentication specified by your provider.</p> <p>Possible values:</p> <ul style="list-style-type: none"> • <i>PAP</i> (default value) Only run <i>PAP</i> (PPP Password Authentication Protocol); the password is transferred unencrypted. • <i>CHAP</i>: Only run <i>CHAP</i> (PPP Challenge Handshake Authentication Protocol as per RFC 1994); the password is transferred encrypted. • <i>PAP/CHAP</i>: Primarily run CHAP, otherwise PAP. • <i>MS-CHAPv1</i>: Only run MS-CHAP version 1 (PPP Microsoft Challenge Handshake Authentication Protocol). • <i>PAP/CHAP/MS-CHAP</i> : Primarily run CHAP, on denial then

Field	Description
	<p>the authentication protocol required by the connection partner. (MSCHAP version 1 or 2 possible.)</p> <ul style="list-style-type: none"> • <i>MS-CHAPv2</i>: Run MS-CHAP version 2 only.
DNS Negotiation	<p>Select whether your device receives IP addresses for primary DNS server and secondary DNS server from the connection partner or sends these to the connection partner.</p> <p>The function is activated with <i>Enabled</i>.</p> <p>The function is enabled by default.</p>
Prioritize TCP ACK Packets	<p>Select whether the TCP download is to be optimised in the event of intensive TCP upload. This function can be specially applied for asymmetrical bandwidths (ADSL).</p> <p>The function is activated with <i>Enabled</i>.</p> <p>The function is disabled by default.</p>
LCP Alive Check	<p>Check whether the availability of the remote terminal is to be checked by sending LCP echo requests or replies. This makes it possible to switch to a backup connection more quickly in the event of line faults.</p> <p>The function is activated with <i>Enabled</i>.</p> <p>The function is disabled by default.</p>

10.1.2 PPTP

In the **WAN** -> **Internet + Dialup** -> **PPTP** menu, a list of all PPTP interfaces is shown.

In this menu, you configure an Internet connection that uses the Point Tunneling Protocol (PPTP) to set up a connection, e.g. required in Austria.

10.1.2.1 New

Choose the **New** button to set up new PPTP interfaces.

The screenshot shows the configuration interface for a bintec R1200 device. The left sidebar contains a navigation menu with categories like System Management, Physical Interfaces, LAN, Wireless LAN, Routing, WAN, VPN, Firewall, VoIP, Local Services, Maintenance, External Reporting, and Monitoring. The WAN section is expanded to show 'Internet + Dialup', 'Leased Line', and 'Real Time Jitter Control'. The 'Internet + Dialup' section is further expanded to show 'PPTP' and 'New'. The main configuration area is titled 'Basic Parameters' and includes fields for Description, PPTP Interface (set to 'Select one'), User Name, Password, Always on (checkbox), Connection Idle Timeout (300 Seconds), IP Mode and Routes (Static/Get IP Address), Default Route (checkbox), and Create NAT Policy (checkbox). Below this is the 'Advanced Settings' section with fields for Block after connection failure for (60 Seconds), Maximum Number of Dialup Retries (5), Authentication (PAP), DNS Negotiation (checkbox), Prioritize TCP ACK Packets (checkbox), PPTP Address Mode (Static), Local PPTP IP Address (10.0.0.140), Remote PPTP IP Address (10.0.0.138), and LCP Alive Check (checkbox). The interface also features a 'Save configuration' button at the top left and 'OK' and 'Cancel' buttons at the bottom right.

Fig. 114: WAN -> Internet + Dialup ->PPTP -> New

The WAN -> Internet + Dialup -> PPTP-> New menu consists of the following fields:

Fields in the PPTP Basic Parameters menu

Field	Description
Description	Enter a name for uniquely identifying the internet connection. The first character in this field must not be a number and no special characters or umlauts must be used either.
PPTP Interface	Select the IP interface over which packets are to be transported to the remote PPTP terminal. If you want to use an external DSL modem, select the Ethernet port to which the modem is connected.

Field	Description
	<p>When using the internal DSL modem, select here the EthoA interface, e.g. <i>ethoa50-0</i>, configured for this connection in Physical Interfaces-> ATM-> Profiles-> New.</p> <p>The default value is <i>Not specified</i>.</p>
User Name	Enter the user name.
Password	Enter the password.
Always on	<p>Select whether the interface should always be activated.</p> <p>The function is activated with <i>Enabled</i>.</p> <p>The function is disabled by default.</p> <p>Only activate this option if you have Internet access with a flat-rate charge.</p>
Connection Idle Timeout	<p>Only if Always enabled (flatrate mode) is disabled.</p> <p>Enter the idle interval in seconds. This determines how many seconds should pass between sending the last traffic data packet and clearing the connection.</p> <p>Possible values are <i>0</i> to <i>3600</i> (seconds). <i>0</i> deactivates the timeout.</p> <p>The default value is <i>300</i>.</p> <p>Example: <i>10</i> for FTP transmission, <i>20</i> for LAN-to-LAN transmission, <i>90</i> for Internet connections.</p>

Fields in the PPTP IP Mode and Routes menu

Field	Description
IP Address Mode	<p>Select whether your device is to be assigned a static IP address or whether it should be assigned this dynamically.</p> <p>Possible values:</p> <ul style="list-style-type: none"> • <i>Get IP Address</i> (default value): Your device is automatically assigned a temporarily valid IP address from the provider. • <i>Static</i>: You enter a static IP address.

Field	Description
Default Route	<p>Select whether the route to this connection partner is to be defined as the default route.</p> <p>The function is activated with <i>Enabled</i>.</p> <p>The function is enabled by default.</p>
Create NAT Policy	<p>Specify whether Network Address Translation (NAT) is to be activated.</p> <p>The function is activated with <i>Enabled</i>.</p> <p>The function is enabled by default.</p>
Local IP Address	<p>Only for IP Address Mode = <i>Static</i></p> <p>Assign an IP address from your LAN to the PPT interface, which is to be used as your device's internal source address.</p>
Route Entries	<p>Only if IP Address Mode = <i>Static</i></p> <p>Define other routing entries for this PPTP partner.</p> <p>Add a new entry with Add.</p> <ul style="list-style-type: none"> • <i>Remote IP Address</i>: IP address of the destination host or destination network. • <i>Netmask</i>: Netmask of Remote IP Address. If no entry is made, your device uses a default netmask. • <i>Metric</i>: The lower the value, the higher the priority of the route (possible values 0... 15). The default value is 1.

The **Advanced Settings** menu consists of the following fields:

Fields in the Advanced Settings menu

Field	Description
Block after connection failure for	Enter the wait time in seconds before the device should try again after an attempt to set up a connection has failed. The default value is 60.
Maximum Number of Dialup Retries	Enter the number of unsuccessful attempts to setup a connection before the interface is blocked.

Field	Description
	<p>Possible values are <i>0</i> to <i>100</i>.</p> <p>The default value is <i>5</i>.</p>
Authentication	<p>Select the authentication protocol for this Internet connection. Select the authentication specified by your provider.</p> <p>Possible values:</p> <ul style="list-style-type: none"> • <i>PAP</i> (default value) Only run <i>PAP</i> (PPP Password Authentication Protocol); the password is transferred unencrypted. • <i>CHAP</i>: Only run <i>CHAP</i> (PPP Challenge Handshake Authentication Protocol as per RFC 1994); the password is transferred encrypted. • <i>PAP/CHAP</i>: Primarily run CHAP, otherwise PAP. • <i>MS-CHAPv1</i>: Only run MS-CHAP version 1 (PPP Microsoft Challenge Handshake Authentication Protocol). • <i>PAP/CHAP/MS-CHAP</i> : Run primarily CHAP, if denied then the authentication protocol required by the PPTP partner (MSCHAP version 1 or 2 possible). • <i>MS-CHAPv2</i>: Run MS-CHAP version 2 only.
DNS Negotiation	<p>Select whether your device receives IP addresses for primary DNS server and secondary DNS server from the connection partner or sends these to the connection partner.</p> <p>The function is activated with <i>Enabled</i>.</p> <p>The function is enabled by default.</p>
Prioritize TCP ACK Packets	<p>Select whether the TCP download is to be optimised in the event of intensive TCP upload. This function can be specially applied for asymmetrical bandwidths (ADSL).</p> <p>The function is activated with <i>Enabled</i>.</p> <p>The function is disabled by default.</p>
PPTP Address Mode	<p>Displays the address mode. The value cannot be changed.</p> <p>Possible values:</p> <ul style="list-style-type: none"> • <i>Static</i>: The IP address of the Ethernet port selected in

Field	Description
	PPTP Interface will be used.
Local PPTP IP Address	Assign the PPTP interface an IP address that is used as the source address. The default value is <i>10.0.0.140</i> .
Remote PPTP IP Address	Enter the IP address of the PPTP partner. The default value is <i>10.0.0.138</i> .
LCP Alive Check	Check whether the availability of the remote terminal is to be checked by sending LCP echo requests or replies. This makes it possible to switch to a backup connection more quickly in the event of line faults. The function is activated with <i>Enabled</i> . The function is disabled by default.

10.1.3 PPPoA

In the **WAN -> Internet + Dialup -> PPPoA** menu, a list of all PPPoA interfaces is shown.

In this menu, you configure a xDSL connection used to set up PPPoA connections. With PPPoA, the connection is configured so that the PPP data flow is transported directly over an ATM network (RFC 2364). This is required by some providers. Note your provider's specifications.

When using the internal DSL modem, a PPPoA interface must be configured for this connection in **Physical Interfaces -> ATM -> Profiles -> New** with **Client Type = On demand**.

10.1.3.1 New

Choose the **New** button to set up new PPPoA interfaces.

The screenshot shows the configuration page for a new PPPoA connection. The left sidebar contains a navigation menu with categories like System Management, Physical Interfaces, LAN, Routing, WAN, VPN, Firewall, VoIP, Local Services, Maintenance, External Reporting, and Monitoring. The 'WAN' category is expanded to show 'Internet + Dialup', 'ATM', 'Leased Line', and 'Real Time Jitter Control'. The 'Internet + Dialup' sub-menu is further expanded to show 'PPPoE', 'PPTP', 'PPPoA', 'ISDN', 'AUX', and 'IP Pools'. The 'PPPoA' option is selected.

The main configuration area is divided into two sections: 'Basic Parameters' and 'Advanced Settings'. The 'Basic Parameters' section includes fields for Description, ATM PVC (a dropdown menu), User Name, Password, Always on (checkbox), Connection Idle Timeout (300 seconds), IP Mode and Routes (radio buttons for Static and Get IP Address), Default Route (checkbox), and Create NAT Policy (checkbox). The 'Advanced Settings' section includes fields for Block after connection failure for (60 seconds), Maximum Number of Dialup Retries (5), Authentication (dropdown menu), DNS Negotiation (checkbox), Prioritize TCP ACK Packets (checkbox), and LCP Alive Check (checkbox). At the bottom of the configuration area are 'OK' and 'Cancel' buttons.

Fig. 115: WAN -> Internet + Dialup -> PPPoA -> New

The WAN -> Internet + Dialup -> PPPoA-> New menu consists of the following fields:

Fields in the PPPoA Basic Parameters menu

Field	Description
Description	Enter a name for uniquely identifying the connection partner. The first character in this field must not be a number and no special characters or umlauts must be used either.
ATM PVC	Select an ATM profile created in the ATM -> Profiles menu, indicated by the global identifiers VPI and VCI specified by the provider.
User Name	Enter the user name.
Password	Enter the password for the PPPoA connection.
Always on	Select whether the interface should always be activated.

Field	Description
	<p>The function is activated with <i>Enabled</i>.</p> <p>The function is disabled by default.</p> <p>Only activate this option if you have Internet access with a flat-rate charge.</p>
Connection Idle Timeout	<p>Only if Always enabled (flatrate mode) is disabled.</p> <p>Enter the idle time in seconds for static short hold. The static short hold setting determines how many seconds should pass between sending the last traffic data packet and clearing the connection.</p> <p>Possible values are 0 to 3600 (seconds). 0 deactivates the short hold.</p> <p>The default value is 300.</p> <p>Example: 10 for FTP transmission, 20 for LAN-to-LAN transmission, 90 for Internet connections.</p>

Fields in the PPPoA IP Mode and Routes menu

Field	Description
IP Address Mode	<p>Choose whether your device has a static IP address or is assigned one dynamically.</p> <p>Possible values:</p> <ul style="list-style-type: none"> • <i>Get IP Address</i> (default value): Your device is dynamically assigned an IP address. • <i>Static</i>: You enter a static IP address.
Default Route	<p>Select whether the route to this connection partner is to be defined as the default route.</p> <p>The function is activated with <i>Enabled</i>.</p> <p>The function is enabled by default.</p>
Create NAT Policy	<p>Specify whether Network Address Translation (NAT) is to be activated.</p> <p>The function is activated with <i>Enabled</i>.</p>

Field	Description
	The function is enabled by default.
Local IP Address	Only if IP Address Mode = <i>Static</i> Enter the static IP address you received from your provider.
Route Entries	Only if IP Address Mode = <i>Static</i> Define other routing entries for this connection partner. Add a new entry with Add . <ul style="list-style-type: none"> • <i>Remote IP Address</i>: IP address of the destination host or LAN. • <i>Netmask</i>: Netmask of Remote IP Address. • <i>Metric</i>: The lower the value, the higher the priority of the route (possible values 0 . . . 15). The default value is 1.

The **Advanced Settings** menu consists of the following fields:

Fields in the Advanced Settings menu

Field	Description
Block after connection failure for	Enter the wait time in seconds before the device should try again after an attempt to set up a connection has failed. The default value is 60.
Maximum Number of Dialup Retries	Enter the number of unsuccessful attempts to setup a connection before the interface is blocked. Possible values are 0 to 100. The default value is 5.
Authentication	Select the authentication protocol for this Internet connection. Select the authentication specified by your provider. Possible values: <ul style="list-style-type: none"> • <i>PAP</i> (default value) Only run <i>PAP</i> (PPP Password Authentication Protocol); the password is transferred unencrypted. • <i>CHAP</i>: Only run <i>CHAP</i> (PPP Challenge Handshake Authentication Protocol as per RFC 1994); the password is transferred encrypted.

Field	Description
	<ul style="list-style-type: none"> • <i>PAP/CHAP</i>: Primarily run CHAP, otherwise PAP. • <i>MS-CHAPv1</i>: Only run MS-CHAP version 1 (PPP Microsoft Challenge Handshake Authentication Protocol). • <i>PAP/CHAP/MS-CHAP</i> : Primarily run CHAP, on denial, the authentication protocol required by the PPTP partner. (MSCHAP version 1 or 2 possible.) • <i>MS-CHAPv2</i>: Run MS-CHAP version 2 only.
DNS Negotiation	<p>Select whether your device receives IP addresses for primary domain name server and secondary domain name server from the connection partner or sends these to the connection partner.</p> <p>The function is activated with <i>Enabled</i>.</p> <p>The function is enabled by default.</p>
Prioritize TCP ACK Packets	<p>Select whether the TCP download is to be optimised in the event of intensive TCP upload. This function can be specially applied for asymmetrical bandwidths (ADSL).</p> <p>The function is activated with <i>Enabled</i>.</p> <p>The function is disabled by default.</p>
LCP Alive Check	<p>Check whether the availability of the remote terminal is to be checked by sending LCP echo requests or replies. This is recommended for leased lines, PPTP and L2TP connections.</p> <p>The function is activated with <i>Enabled</i>.</p> <p>The function is disabled by default.</p>

10.1.4 ISDN

In the **WAN -> Internet + Dialup + ISDN** menu, a list of all ISDN interfaces is shown.

In this menu, you configure the following ISDN connections:

- Internet access over ISDN
- LAN-to-LAN connection over ISDN
- Remote (Mobile) Dialin

- Use of the ISDN Callback function

10.1.4.1 New

Choose the **New** button to set up new ISDN interfaces.

bintec R1200 Language: English Online Help Logout **funkwerk** enterprise communications

Save configuration

System Management
Physical Interfaces
LAN
Wireless LAN
Routing
WAN
Internet + Dialup
Leased Line
Real Time Jitter Control
VPN
Firewall
VoIP
Local Services
Maintenance
External Reporting
Monitoring

PPPoE PPTP **ISDN** GPRS/UMTS AUX IP Pools

Basic Parameters

Description

Connection Type: ISDN 64 kbps

User Name

Remote User (for Dialin only)

Password:

Always on: Enabled

Connection Idle Timeout: 20 Seconds

IP Mode and Routes

IP Address Mode: Static Provide IP Address Get IP Address

Default Route: Enabled

Create NAT Policy: Enabled

Local IP Address

Route Entries

Remote IP Address	Netmask	Metric
		1

Add

Advanced Settings

Block after connection failure for: 300 Seconds

Maximum Number of Dialup Retries: 5

Usage Type: Standard Dialin only Multi-User (Dialin only)

Authentication: PAP/CHAP/MS-CHAP

Callback Mode: None Active Passive

Bandwidth on Demand Options

Channel Bundling: None

Dial Numbers

Entries

Mode	Number	Number of Used Ports

Add

IP Options

OSPF Mode: Passive Active Inactive

Proxy ARP Mode: Inactive Up or Dormant Up only

DNS Negotiation: Enabled

OK Cancel

Fig. 116: WAN -> Internet + Dialup ->ISDN -> New

The **WAN -> Internet + Dialup -> ISDN-> New** menu consists of the following fields:

Fields in the ISDN Basic Parameters menu

Field	Description
Description	<p>Enter a name for uniquely identifying the connection partner.</p> <p>The first character in this field must not be a number and no special characters or umlauts must be used either.</p>
Connection Type	<p>Select which layer 1 protocol your device should use.</p> <p>This setting applies for outgoing connections to the connection partner and only for incoming connections from the connection partner if they could be identified on the basis of the calling party number.</p> <p>Possible values:</p> <ul style="list-style-type: none"> • <i>ISDN 64kbps</i>: For 64-kbps ISDN data connections. • <i>ISDN 56kbps</i>: For 56-kbps ISDN data connections.
User Name	Enter your device code (local PPP user name).
Remote User (for Dialin only)	Enter the code of the remote terminal (remote PPP user name).
Password	Enter the password.
Always on	<p>Select whether the interface should always be activated.</p> <p>The function is activated with <i>Enabled</i>.</p> <p>The function is disabled by default.</p> <p>Only activate this option if you have Internet access with a flat-rate charge.</p>
Connection Idle Timeout	<p>Enter the idle time in seconds for static short hold. The static short hold setting determines how many seconds should pass between sending the last traffic data packet and clearing the connection.</p> <p>Possible values are <i>-1</i> to <i>3600</i> (seconds). A value of <i>-1</i> means that the connection is set up again immediately after disconnection and <i>0</i> deactivates short hold. The default value is <i>20</i>.</p>

Fields in the ISDN IP Mode and Routes menu

Field	Description
IP Address Mode	<p>Select whether your device is to be assigned a static IP address or whether it should be assigned this dynamically.</p> <p>Possible values:</p> <ul style="list-style-type: none"> • <i>Static</i> (default value): You enter a static IP address. • <i>Provide IP Address</i>: Your device dynamically assigns an IP address to the remote terminal. • <i>Get IP Address</i>: Your device is dynamically assigned an IP address.
Default Route	<p>Only if IP Address Mode = <i>Static</i> and <i>Get IP Address</i></p> <p>Select whether the route to this connection partner is to be defined as the default route.</p> <p>The function is activated with <i>Enabled</i>.</p> <p>The function is disabled by default.</p>
Create NAT Policy	<p>Only if IP Address Mode = <i>Static</i> and <i>Get IP Address</i></p> <p>When you configure an ISDN Internet connection, specify whether Network Address Translation (NAT) is to be activated.</p> <p>The function is activated with <i>Enabled</i>.</p> <p>The function is disabled by default.</p>
Local IP Address	<p>Only if IP Address Mode = <i>Static</i></p> <p>Assign the IP address from your LAN to the ISDN interface which is to be used as your device's internal source address.</p>
Route Entries	<p>Only if IP Address Mode = <i>Static</i></p> <p>Define other routing entries for this connection partner.</p> <ul style="list-style-type: none"> • <i>Remote IP Address</i>: IP address of the destination host or LAN.

Field	Description
	<ul style="list-style-type: none"> • <i>Netmask</i>: Netmask for Destination IP Address. • <i>Metric</i>: The lower the value, the higher the priority of the route (possible values 0 . . . 15). The default value is 1.
IP Assignment Pool	<p>Only if IP Address Mode = <i>Provide IP Address</i></p> <p>Select an IP pool configured in the WAN -> Internet + Dialup -> IP Pools menu. If an IP pool has not been configured here yet, the message <i>Not yet defined</i> appears in this field.</p>

The **Advanced Settings** menu consists of the following fields:

Fields in the Advanced Settings menu

Field	Description
Block after connection failure for	<p>Enter the wait time in seconds before the device should try again after an attempt to set up a connection has failed.</p> <p>The default value is 300.</p>
Maximum Number of Dialup Retries	<p>Enter the number of unsuccessful attempts to setup a connection before the interface is blocked.</p> <p>Possible values are 0 to 100.</p> <p>The default value is 5.</p>
Usage Type	<p>If necessary, select a special interface use.</p> <p>Possible values:</p> <ul style="list-style-type: none"> • <i>Standard</i> (default value): No special type is selected. • <i>Dialin only</i>: The interface is used for incoming dialup connections and callbacks initiated externally. • <i>Multi-User (Dialin only)</i>: The interface is defined as multi-user connection partner, i.e. several clients dial in with the same user name and password.
Authentication	<p>Select the authentication protocol for this PPTP partner.</p> <p>Possible values:</p> <ul style="list-style-type: none"> • <i>PAP/CHAP/MS-CHAP</i> (default value): Primarily run CHAP, on denial, the authentication protocol required by the PPTP part-

Field	Description
	<p>ner. (MSCHAP version 1 or 2 possible.)</p> <ul style="list-style-type: none"> • <i>PAP</i>: Only run <i>PAP</i> (PPP Password Authentication Protocol); the password is transferred unencrypted. • <i>CHAP</i>: Only run <i>CHAP</i> (PPP Challenge Handshake Authentication Protocol as per RFC 1994); the password is transferred encrypted. • <i>PAP/CHAP</i>: Primarily run CHAP, otherwise PAP. • <i>MS-CHAPv1</i>: Only run MS-CHAP version 1 (PPP Microsoft Challenge Handshake Authentication Protocol). • <i>MS-CHAPv2</i>: Run MS-CHAP version 2 only.
Encryption	<p>Only for PPP Authentication = <i>MS-CHAPv2</i></p> <p>If necessary, select the type of encryption that should be used for data traffic to the connection partner. This is only possible if STAC or MS-STAC compression is not activated for the connection. If Encryption is set, the remote terminal must also support it, otherwise a connection cannot be set up.</p> <p>Possible values:</p> <ul style="list-style-type: none"> • <i>None</i> (default value): MPP encryption is not used. • <i>Enabled</i>. MPP encryption V2 with 128 bit is used to RFC 3078. • <i>Windows compatible</i>: MPP encryption V2 with 128 bit is used as compatible with Microsoft and Cisco.
Callback Mode	<p>Select the Callback Mode function.</p> <p>Possible values:</p> <ul style="list-style-type: none"> • <i>None</i> (default value): Your device does not call back. • <i>Active</i>: Select one of the following options: <ul style="list-style-type: none"> • <i>No PPP Negotiation</i>: Your device calls the connection partner to request a callback. • <i>Windows Client Mode</i>: Your device calls the connection partner to request a callback via CBCP (Callback Control Protocol). Needed for Windows clients. • <i>Passive</i>: Select one of the following options: <ul style="list-style-type: none"> • <i>Enabled</i>. Your device calls back immediately when re-

Field	Description
	<p>requested to do so by the connection partner.</p> <ul style="list-style-type: none"> • <i>Windows Server Mode</i> : Your device calls back after a period of time proposed by the Microsoft client (NT: 10 seconds, new systems: 12 seconds. It uses the subscriber number (Entries-> Number (MSN)) with the Mode <i>Outgoing</i> or <i>Both</i> that has been entered for the other party. If no number is entered, the required number can be reported by the caller in a PPP negotiation. This setting should be avoided where possible for security reasons. Currently cannot be avoided for the connection of mobile Microsoft clients via DCN. • <i>Delayed, CLID only</i> : Your device calls back after approx. four seconds if your device is requested to do so by the connection partner. Only makes sense for CLID. • <i>Windows Server Mode, Callback optional</i> : Like <i>Windows Server Mode</i> but with the option of aborting. This setting should be avoided for security reasons. The Microsoft client also has the option of aborting callback and maintaining the initial connection to your device without callback. This only applies if no fixed, outgoing number has been configured for the connection partner. This is done by pressing CANCEL to close the dialog box that appears.

Fields in the Advanced Settings Options for On-demand Bandwidth menu

Field	Description
Channel Bundling	<p>Select whether channel bundling is to be used for ISDN connections with the connection partner, and if so, what type.</p> <p>Your device supports dynamic and static channel bundling for dialup connections. Only one B channel is initially opened when a connection is set up. Dynamic channel bundling means that your device connects other ISDN B channels to increase the throughput for connections if this is required, e.g. for large data rates. If the amount of data traffic drops, the additional B channels are closed again. In static channel bundling, you specify right from the start how many B channels your device is to use, regardless of the transferred data rate.</p> <p>Possible values:</p> <ul style="list-style-type: none"> • <i>None</i> (default value): No channel bundling, only one B chan-

Field	Description
	<p>nel is ever available for connections.</p> <ul style="list-style-type: none"> • <i>Static</i>: Static channel bundling. • <i>Dynamic</i>: Dynamic channel bundling.

Fields in the Advanced Settings Dial Numbers menu

Field	Description
Entries	Add new entries with Add .

Fields in the Dial Number Configuration Entry: <1> menu (only shown for Entries = Add)

Field	Description
Mode	<p>Only if Entries = <i>Add</i>.</p> <p>Select whether Subscriber Number (MSN) is to be used for incoming or outgoing calls or for both. Possible values:</p> <ul style="list-style-type: none"> • <i>Both</i> (default value): For incoming and outgoing calls. • <i>Incoming</i>: For incoming calls, where your connection partner dials in to your device. • <i>Outgoing</i>: For outgoing calls, where you dial your connection partner. <p>The calling party number of the incoming call is compared with the number entered under Subscriber Number (MSN).</p>
Call Number	Enter the connection partner's numbers.
Port Usage	Select which port is used.

Fields in the Advanced Settings IP Options menu

Field	Description
OSPF Mode	<p>Select whether and how routes are propagated via the interface and/or OSPF protocol packets are sent.</p> <p>Possible values:</p> <ul style="list-style-type: none"> • <i>Passive</i> (default value) OSPF is not activated for this interface, i.e. no routes are propagated or OSPF protocol packets sent over this interface. Networks reachable over this interface are, however, included when calculating the routing information and propagated over active interfaces.

Field	Description
	<ul style="list-style-type: none"> • <i>Active</i>: OSPF is activated for this interface, i.e. routes are propagated or OSPF protocol packets sent over this interface. • <i>Down</i> : OSPF is disabled for this interface.
Proxy ARP Mode	<p>Select whether and how ARP requests from your own LAN are to be responded to for the specified connection partner.</p> <p>Possible values:</p> <ul style="list-style-type: none"> • <i>Inactive</i> (default value): Deactivates Proxy ARP for this connection partner. • <i>Active or Idle</i>: Your device only responds to an ARP request if the status of the connection to the connection partner is <i>Up</i> or <i>Dormant</i>. In the case of <i>Idle</i>, your device only responds to the ARP request; the connection is not set up until someone actually wants to use the route. • <i>Active Only</i>: Your device responds to an ARP request only if the status of the connection to the connection partner is <i>Up</i> (active), i.e. a connection already exists to the connection partner.
DNS Negotiation	<p>Select whether your device receives IP addresses for primary DNS server, secondary DNS server, primary WINS and secondary WINS from the connection partner or sends these to the connection partner.</p> <p>The function is activated with <i>Enabled</i>.</p> <p>The function is enabled by default.</p>

10.1.5 GPRS/UMTS



Note

Note that the **GPRS/UMTS** menu is only available if a UMTS modem card is inserted in the CardBus slot and is integrated in the system! Not all **bintec** gateways have a CardBus interface. Refer to the data sheet to determine whether your gateway has this interface type.

In the **WAN -> Internet + Dialup -> GPRS/UMTS** menu, a list of all GPRS/UMTS interfaces is shown.

Thanks to its CardBus interface (PCCARD), the **bintec** gateway supports the integration of a UMTS CardBus modem in the system. This enables you to set up a connection to the Internet over UMTS.

10.1.5.1 New

Choose the **New** button to set up additional interfaces.

The screenshot shows the configuration page for a new GPRS/UMTS interface. The left sidebar contains a navigation menu with the following items: Save configuration, System Management, Physical Interfaces, LAN, Wireless LAN, Routing, WAN (expanded), Internet + Dialup (selected), Leased Line, Real Time Jitter Control, VPN, Firewall, VoIP, Local Services, Maintenance, External Reporting, and Monitoring. The main content area has a header with 'Language English', 'Online Help', 'Logout', and the 'funkwerk' logo. Below the header are tabs for 'PPPoE', 'PPTP', 'ISDN', 'GPRS/UMTS', 'AUX', and 'IP Pools'. The 'GPRS/UMTS' tab is active, showing two sections: 'Basic Parameters' and 'Advanced Settings'. The 'Basic Parameters' section includes: Description (text input), GPRS/UMTS Interface (dropdown menu showing 'Slot 6 Unit 0 UMTS'), User Name (text input), Password (password input), Always on (checkbox, currently disabled), and Connection Idle Timeout (input field with '300' and 'Seconds' label). The 'Advanced Settings' section includes: Block after connection failure for (input field with '60' and 'Seconds' label), Maximum Number of Dialup Retries (input field with '5'), Authentication (dropdown menu showing 'PAP'), DNS Negotiation (checkbox, currently enabled), Prioritize TCP ACK Packets (checkbox, currently disabled), and LCP Alive Check (checkbox, currently disabled). At the bottom of the form are 'OK' and 'Cancel' buttons.

Fig. 117: WAN -> Internet + Dialup -> GPRS/UMTS -> New

The **WAN -> Internet + Dialup -> GPRS/UMTS -> New** menu consists of the following fields:

Fields in the GPRS/UMTS Basic Parameters menu

Field	Description
Description	Enter a name for uniquely identifying the WAN partner. The first character in this field must not be a number and no special characters or umlauts must be used either.

Field	Description
GPRS/UMTS Interface	Select the GPRS/UMTS interface.
User Name	Enter the user name.
Password	Enter the password.
Always on	<p>Select whether the interface should always be activated.</p> <p>The function is activated with <i>Enabled</i>.</p> <p>The function is disabled by default.</p> <p>Only activate this option if you have Internet access with a flat-rate charge.</p>
Connection Idle Timeout	<p>Only if Always up is disabled.</p> <p>Enter the idle time in seconds for static short hold. The static short hold setting determines how many seconds should pass between sending the last traffic data packet and clearing the connection.</p> <p>Possible values are 0 to 3600 (seconds). 0 deactivates the short hold.</p> <p>The default value is 300.</p>

Fields in the GPRS/UMTS IP Mode and Routes menu

Field	Description
IP Address Mode	<p>Select whether your device is to be assigned a static IP address or whether it should be assigned this dynamically.</p> <p>Possible values:</p> <ul style="list-style-type: none"> • <i>Get IP Address</i> (default value): Your device is dynamically assigned an IP address. • <i>Static</i>: You enter a static IP address.
Default Route	<p>Select whether the route to this connection partner is to be defined as the default route.</p> <p>The function is activated with <i>Enabled</i>.</p> <p>The function is enabled by default.</p>

Field	Description
Create NAT Policy	<p>Specify whether Network Address Translation (NAT) is to be activated.</p> <p>The function is activated with <i>Enabled</i>.</p> <p>The function is enabled by default.</p>
Local IP Address	<p>Only if IP Address Mode = <i>Static</i></p> <p>Enter the static IP address of the connection partner.</p>
Route Entries	<p>Only if IP Address Mode = <i>Static</i></p> <p>Define other routing entries for this connection partner.</p> <p>Add a new entry with Add.</p> <ul style="list-style-type: none"> • <i>Remote IP Address</i>: IP address of the destination host or network. • <i>Netmask</i>: Netmask of Remote IP Address. If no entry is made, your device uses a default netmask. • <i>Metric</i>: The lower the value, the higher the priority of the route (possible values 0... 15). The default value is 1.

The **Advanced Settings** menu consists of the following fields:

Fields in the Advanced Settings menu

Field	Description
Block after connection failure for	<p>Enter the wait time in seconds before the device should try again after an attempt to set up a connection has failed. The default value is 60.</p>
Maximum Number of Dialup Retries	<p>Enter the number of unsuccessful attempts to setup a connection before the interface is blocked.</p> <p>Possible values are 0 to 100.</p> <p>The default value is 5.</p>
Authentication	<p>Select the authentication protocol for this connection partner. Select the authentication specified by your provider.</p> <p>Possible values:</p>

Field	Description
	<ul style="list-style-type: none"> • <i>PAP</i> (default value) Only run <i>PAP</i> (PPP Password Authentication Protocol); the password is transferred unencrypted. • <i>CHAP</i>: Only run <i>CHAP</i> (PPP Challenge Handshake Authentication Protocol as per RFC 1994); the password is transferred encrypted. • <i>PAP/CHAP</i>: Primarily run CHAP, otherwise PAP. • <i>MS-CHAPv1</i>: Only run MS-CHAP version 1 (PPP Microsoft Challenge Handshake Authentication Protocol). • <i>PAP/CHAP/MS-CHAP</i> : Primarily run CHAP, on denial then the authentication protocol required by the connection partner. (MSCHAP version 1 or 2 possible.) • <i>MS-CHAPv2</i>: Run MS-CHAP version 2 only.
DNS Negotiation	<p>Select whether your device receives IP addresses for primary DNS server and secondary DNS server from the connection partner or sends these to the connection partner.</p> <p>The function is activated with <i>Enabled</i>.</p> <p>The function is enabled by default.</p>
Prioritize TCP ACK Packets	<p>Select whether the TCP download is to be optimised in the event of intensive TCP upload. This function can be specially applied for asymmetrical bandwidths (ADSL).</p> <p>The function is activated with <i>Enabled</i>.</p> <p>The function is disabled by default.</p>
LCP Alive Check	<p>Check whether the availability of the remote terminal is to be checked by sending LCP echo requests or replies. This makes it possible to switch to a backup connection more quickly in the event of line faults.</p> <p>The function is activated with <i>Enabled</i>.</p> <p>The function is disabled by default.</p>

10.1.6 AUX

In the **WAN -> Internet + Dialup -> AUX** menu, a list of all AUX interfaces is shown.

You can define various settings for communication between the gateway and modem in this menu. You require a special cable for the console port of your gateway (e.g. AUX Backup cable) to connect an external analogue modem to the AUX port on a **bintec** gateway.

10.1.6.1 New

Choose the **New** button to set up new AUX interfaces.

The screenshot shows the web interface for a bintec R1200 gateway. The left sidebar contains a navigation menu with categories like System Management, Physical Interfaces, LAN, Wireless LAN, Routing, WAN, VPN, Firewall, VoIP, Local Services, Maintenance, External Reporting, and Monitoring. The 'WAN' section is expanded, showing 'Internet + Dialup', 'Leased Line', and 'Real Time Jitter Control'. The 'Internet + Dialup' section is further expanded to show 'AUX' and 'IP Pools'. The 'AUX' section is selected, and the 'New' button is visible. The main content area displays the configuration form for a new AUX interface, which is divided into two sections: 'Basic Parameters' and 'Advanced Settings'.

Basic Parameters

Description	<input type="text"/>
User Name	<input type="text"/>
Password	<input type="password"/>
Always on	<input type="checkbox"/> Enabled
Connection Idle Timeout	600 Seconds
IP Mode and Routes	
IP Address Mode	<input type="radio"/> Static <input type="radio"/> Provide IP Address <input checked="" type="radio"/> Get IP Address
Default Route	<input checked="" type="checkbox"/> Enabled
Create NAT Policy	<input checked="" type="checkbox"/> Enabled

Advanced Settings

Block after connection failure for	50 Seconds				
Maximum Number of Dialup Retries	5				
Usage Type	<input checked="" type="radio"/> Standard <input type="radio"/> Dialin only <input type="radio"/> Multi-User (Dialin only)				
Authentication	PAP				
DNS Negotiation	<input checked="" type="checkbox"/> Enabled				
Prioritize TCP ACK Packets	<input type="checkbox"/> Enabled				
LCP Alive Check	<input type="checkbox"/> Enabled				
Callback Mode	<input checked="" type="radio"/> None <input type="radio"/> Active <input type="radio"/> Passive				
Dial Numbers					
Entries	<table border="1"> <thead> <tr> <th>Mode</th> <th>Number</th> </tr> </thead> <tbody> <tr> <td><input type="text"/></td> <td><input type="text"/></td> </tr> </tbody> </table> <input type="button" value="Add"/>	Mode	Number	<input type="text"/>	<input type="text"/>
Mode	Number				
<input type="text"/>	<input type="text"/>				
IP Options					
Proxy ARP Mode	<input checked="" type="radio"/> Inactive <input type="radio"/> Up or Dormant <input type="radio"/> Up only				

At the bottom of the form, there are two buttons: **OK** and **Cancel**.

Fig. 118: WAN -> Internet + Dialup -> AUX -> New

The WAN -> Internet + Dialup -> AUX -> New menu consists of the following fields:

Fields in the AUX Basic Parameters menu

Field	Description
Description	Enter a name for uniquely identifying the WAN partner. The first character in this field must not be a number and no special characters or umlauts must be used either.
User Name	Enter the user name.
Password	Enter the password.
Always Active	Select whether the interface should always be activated. The function is activated with <i>Enabled</i> . The function is disabled by default. Only activate this option if you have Internet access with a flat-rate charge.
Connection Idle Timeout	Only if Always up is disabled. Enter the idle time in seconds for static short hold. The static short hold setting determines how many seconds should pass between sending the last traffic data packet and clearing the connection. Possible values are 0 to 3600 (seconds). 0 deactivates the short hold. The default value is 600.

Fields in the AUX IP Mode and Routes menu

Field	Description
IP Address Mode	Select whether your device is to be assigned a static IP address or whether it should be assigned this dynamically. Possible values: <ul style="list-style-type: none"> • <i>Get IP Address</i> (default value): Your device is dynamically assigned an IP address. • <i>Static</i>: You enter a static IP address. • <i>Provide IP Address</i>: Your device dynamically assigns an IP address to the remote terminal.
Default Route	Select whether the route to this connection partner is to be

Field	Description
	<p>defined as the default route.</p> <p>The function is activated with <i>Enabled</i>.</p> <p>The function is enabled by default.</p>
Create NAT Policy	<p>Specify whether Network Address Translation (NAT) is to be activated.</p> <p>The function is activated with <i>Enabled</i>.</p> <p>The function is enabled by default.</p>
Local IP Address	<p>Only if IP Address Mode = <i>Static</i></p> <p>Enter the static IP address of the connection partner.</p>
Route Entries	<p>Only if IP Address Mode = <i>Static</i></p> <p>Define other routing entries for this connection partner.</p> <p>Add a new entry with Add.</p> <ul style="list-style-type: none"> • <i>Remote IP Address</i>: IP address of the destination host or network. • <i>Netmask</i>: Netmask of Remote IP Address. If no entry is made, your device uses a default netmask. • <i>Metric</i>: The lower the value, the higher the priority of the route (possible values 0... 15). The default value is 1.
IP Assignment Pool	<p>Only if IP Address Mode = <i>Provide IP Address</i></p> <p>Select an IP pool configured in the WAN -> Internet + Dialup -> IP Pools menu. If an IP pool has not been configured here yet, the message <i>Not yet defined</i> appears in this field.</p>

The **Advanced Settings** menu consists of the following fields:

Fields in the Advanced Settings menu

Field	Description
Block after connection failure for	<p>Enter the wait time in seconds before the device should try again after an attempt to set up a connection has failed.</p> <p>The default value is 50.</p>

Field	Description
Maximum Number of Dialup Retries	<p>Enter the number of unsuccessful attempts to setup a connection before the interface is blocked.</p> <p>Possible values are 0 to 100.</p> <p>The default value is 5.</p>
Usage Type	<p>If necessary, select a special interface use.</p> <p>Possible values:</p> <ul style="list-style-type: none"> • <i>Standard</i> (default value): No special type is selected. • <i>Dialin only</i>: The interface is used for incoming dialup connections and callbacks initiated externally. • <i>Multi-User (Dialin only)</i>: The interface is defined as multi-user connection partner, i.e. several clients dial in with the same user name and password.
Authentication	<p>Select the authentication protocol for this PPTP partner.</p> <p>Possible values:</p> <ul style="list-style-type: none"> • <i>PAP/CHAP/MS-CHAP</i>: Primarily run CHAP, on denial, the authentication protocol required by the PPTP partner. (MSCHAP version 1 or 2 possible.) • <i>PAP</i>: Only <i>PAP</i> (default value): (PPP Password Authentication Protocol); the password is transferred in unencrypted form. • <i>CHAP</i>: Only run <i>CHAP</i> (PPP Challenge Handshake Authentication Protocol as per RFC 1994); the password is transferred encrypted. • <i>PAP/CHAP</i>: Primarily run CHAP, otherwise PAP. • <i>MS-CHAPv1</i>: Only run MS-CHAP version 1 (PPP Microsoft Challenge Handshake Authentication Protocol). • <i>MS-CHAPv2</i>: Run MS-CHAP version 2 only.
DNS Negotiation	<p>Select whether your device receives IP addresses for primary DNS server and secondary DNS server from the connection partner or sends these to the connection partner.</p> <p>The function is activated with <i>Enabled</i>.</p>

Field	Description
	The function is enabled by default.
Prioritize TCP ACK Packets	<p>Select whether the TCP download is to be optimised in the event of intensive TCP upload. This function can be specially applied for asymmetrical bandwidths (ADSL).</p> <p>The function is activated with <i>Enabled</i>.</p> <p>The function is disabled by default.</p>
LCP Alive Check	<p>Check whether the availability of the remote terminal is to be checked by sending LCP echo requests or replies. This makes it possible to switch to a backup connection more quickly in the event of line faults.</p> <p>The function is activated with <i>Enabled</i>.</p> <p>The function is disabled by default.</p>
Callback Mode	<p>Select the Callback Mode function.</p> <p>Possible values:</p> <ul style="list-style-type: none"> • <i>None</i> (default value): Your device does not call back. • <i>Active</i>: Select one of the following options: <ul style="list-style-type: none"> • <i>No PPP Negotiation</i>: Your device calls the connection partner to request a callback. • <i>Windows Client Mode</i>: Your device calls the connection partner to request a callback via CBCP (Callback Control Protocol). Needed for Windows clients. • <i>Passive</i>: Select one of the following options: <ul style="list-style-type: none"> • <i>PPP Negotiation or CLID</i>: Your device calls back immediately when requested to do so by the connection partner. • <i>Windows Server Mode</i>: Your device calls back after a period of time proposed by the Microsoft client (NT: 10 seconds, new systems: 12 seconds. It uses the subscriber number (Entries-> Number (MSN)) with the Mode <i>Outgoing</i> or <i>Both</i> that has been entered for the other party. If no number is entered, the required number can be reported by the caller in a PPP negotiation. This setting should be avoided where possible for security reasons. Currently can-

Field	Description
	<p>not be avoided for the connection of mobile Microsoft clients via DCN.</p> <ul style="list-style-type: none"> • <i>Delayed, CLID only</i>: Your device calls back after approx. four seconds if your device is requested to do so by the connection partner. Only makes sense for CLID. • <i>Windows Server Mode, Callback optional</i>: Like <i>Windows Server Mode</i> but with the option of aborting. This setting should be avoided for security reasons. The Microsoft client also has the option of aborting callback and maintaining the initial connection to your device without callback. This only applies if no fixed, outgoing number has been configured for the connection partner. This is done by pressing CANCEL to close the dialog box that appears.

Fields in the Advanced Settings Dial Numbers menu

Field	Description
Entries	Add new entries with Add .

Fields in the Dial Number Configuration Entry: <1> menu (only shown for Entries = Add)

Field	Description
Mode	<p>Only if Entries = <i>Add</i>.</p> <p>Select whether Subscriber Number (MSN) is to be used for incoming or outgoing calls or for both. Possible values:</p> <ul style="list-style-type: none"> • <i>Both</i> (default value): For incoming and outgoing calls. • <i>Incoming</i>: For incoming calls, where your connection partner dials in to your device. • <i>Outgoing</i>: For outgoing calls, where you dial your connection partner. <p>The calling party number of the incoming call is compared with the number entered under Subscriber Number (MSN).</p>
Call Number	Enter the connection partner's numbers.
Port Usage	Select which port is used.

Fields in the Advanced Settings IP Options menu

Field	Description
Proxy ARP Mode	Select whether and how ARP requests from your own LAN are

Field	Description
	<p>to be responded to for the specified connection partner.</p> <p>Possible values:</p> <ul style="list-style-type: none"> • <i>Inactive</i> (default value): Deactivates Proxy ARP for this connection partner. • <i>Active or Idle</i>: Your device only responds to an ARP request if the status of the connection to the connection partner is <i>Up</i> or <i>Dormant</i>. In the case of <i>Idle</i>, your device only responds to the ARP request; the connection is not set up until someone actually wants to use the route. • <i>Active Only</i>: Your device responds to an ARP request only if the status of the connection to the connection partner is <i>Up</i> (active), i.e. a connection already exists to the connection partner.

10.1.7 IP Pools

In the **IP Pools** menu a list of all IP pools is displayed.

Your device can operate as a dynamic IP address server for PPP connections. You can use this function by providing one or more pools of IP addresses. These IP addresses can be assigned to dialling-in connection partners for the duration of the connection.

Any host routes entered always have priority over IP addresses from the address pools. This means if an incoming call has been authenticated, your device first checks whether a host route is entered in the routing table for this caller. If not, your device can allocate an IP address from an address pool (if available). If address pools have more than one IP address, you cannot specify which connection partner receives which address. The addresses are initially assigned in order. If a new dial-in takes place within an interval of one hour, an attempt is made to allocate the same IP address assigned to this partner the last time.

Use the **Add** button to set up new IP pools.

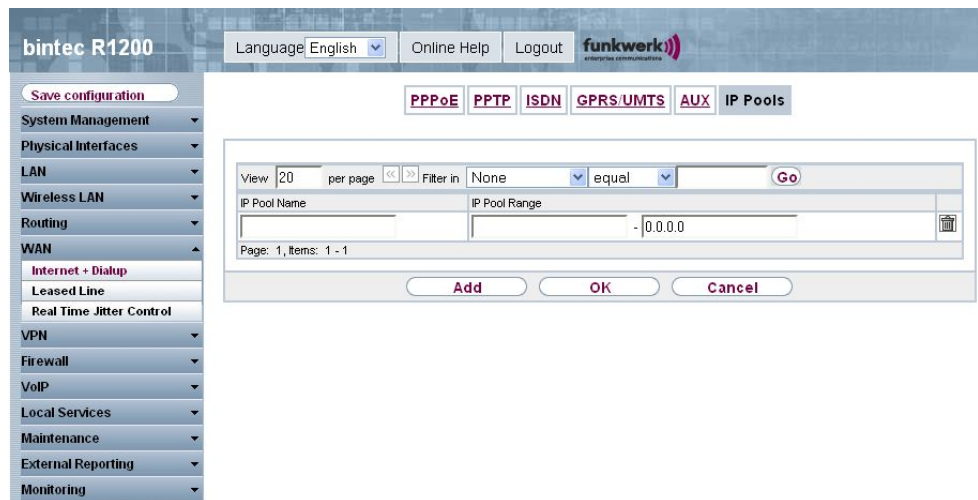

Fig. 119: WAN -> Internet + Dialup -> IP Pools -> Add

The WAN -> Internet + Dialup -> IP Pools-> Add menu consists of the following fields:

Fields in the Options IP Pools menu

Field	Description
IP Pool Name	Enter the name of the IP pool.
IP Pool Range	In the first field, enter the first IP address of the range. In the second field, enter the last IP address of the range.

10.2 ATM

10.2.1 Profiles

In the WAN -> ATM -> Profiles menu, a list of all ATM profiles is shown.

If the connection for your Internet access is set up using the internal modem, the ATM connection parameters must be set for this.

By default an ATM profile with the description *AUTO-CREATED* is preconfigured. Its values (VPI 1 and VCI 32) are suitable for a Telekom ATM connection, for example.



Note

The ATM encapsulations are described in RFCs 1483 and 2684. You will find the RFCs on the relevant pages of the IETF (www.ietf.org/rfc.html).

10.2.1.1 New

Choose the **New** button to set up new ATM profiles.

The screenshot shows the bintec R3800 web interface. The left sidebar contains a navigation menu with options like System Management, Physical Interfaces, LAN, Routing, WAN, VPN, Firewall, VoIP, Local Services, Maintenance, External Reporting, and Monitoring. The main content area is titled 'Profiles' and contains a form for configuring ATM profiles. The form fields are as follows:

ATM Profiles Parameter	
Provider	- User-defined -
Description	
ATM Interface	fcca-3-0
Type	Ethernet over ATM
Virtual Path Identifier (VPI)	9
Virtual Channel Identifier (VCI)	32
Encapsulation	LLC Bridged no FCS
Ethernet over ATM Settings	
Default Ethernet for PPPoE Interfaces	<input type="checkbox"/> Enabled
Address Mode	<input checked="" type="radio"/> Static <input type="radio"/> DHCP
IP Address/Netmask	IP Address: [] Netmask: [] <input type="button" value="Add"/>
MAC Address	[] <input checked="" type="checkbox"/> Use built-in

At the bottom of the form are 'OK' and 'Cancel' buttons.

Fig. 120: WAN -> ATM -> Profiles-> New

The WAN -> ATM -> Profile-> New menu consists of the following fields:

Fields in the Profile ATM Profiles Parameter menu

Field	Description
Provider	Select one of the preconfigured ATM profiles for your provider from the list or manually define the profile using <i>- User-Specified -</i> .
Description	Only for Provider = <i>- User-defined -</i> Enter the desired description for the connection.

Field	Description
ATM Interface	Select one ATM Interface.
Type	<p>Only for Provider = - <i>User-defined</i> -</p> <p>Select the protocol for the ATM connection.</p> <p>Possible values:</p> <ul style="list-style-type: none"> • <i>Ethernet over ATM</i> (default value): Ethernet over ATM (EthoA) is used for the ATM connection (Permanent Virtual Circuit, PVC). • <i>Routed Protocols over ATM</i>: Routed Protocols over ATM (RPoA) is used for the ATM connection (Permanent Virtual Circuit, PVC). • <i>PPP over ATM</i>: PPP over ATM (PPPoA) is used for the ATM connection (Permanent Virtual Circuit, PVC).
Virtual Path Identifier (VPI)	<p>Only for Provider = - <i>User-defined</i> -</p> <p>Enter the VPI value of the ATM connection. The VPI is the identification number of the virtual path to be used. Note your provider's instructions.</p> <p>Possible values are 0 to 255.</p> <p>The default value is 8.</p>
Virtual Channel Identifier (VCI)	<p>Only for Provider = - <i>User-defined</i> -</p> <p>Enter the VCI value of the ATM connection. The VCI is the identification number of the virtual channel. A virtual channel is the logical connection for the transport of ATM cells between two or more points. Note your provider's instructions.</p> <p>Possible values are 32 to 65535.</p> <p>The default value is 32.</p>
Encapsulation	<p>Only for Provider = - <i>User-defined</i> -</p> <p>Select the encapsulation to be used. Note your provider's instructions.</p> <p>Possible values (in accordance with RFC 2684):</p> <ul style="list-style-type: none"> • <i>LLC Bridged no FCS</i> (default value for Ethernet over

Field	Description
	<p>ATM): Only shown for Type = <i>Ethernet over ATM</i>.</p> <p>Bridged Ethernet with LLC/SNAP encapsulation without Frame Check Sequence (checksums).</p> <ul style="list-style-type: none"> • <i>LLC Bridged FCS</i> : Only shown for Type = <i>Ethernet over ATM</i>. <p>Bridged Ethernet with LLC/SNAP encapsulation with Frame Check Sequence (checksums).</p> <ul style="list-style-type: none"> • <i>VC Multiplexing</i> (default value for PPP over ATM): Bridged Ethernet without additional encapsulation (Null Encapsulation) with Frame Check Sequence (checksums).

Fields in the Settings for Ethernet over ATM menu (only shown for Type = Ethernet over ATM)

Field	Description
Default Ethernet for PPPoE Interfaces	<p>Only for Type = <i>Ethernet over ATM</i></p> <p>Select whether this Ethernet-over-ATM interface is to be used for all PPPoE connections</p> <p>The function is activated with <i>Enabled</i>.</p> <p>The function is disabled by default.</p>
Address Mode	<p>Only for Type = <i>Ethernet over ATM</i></p> <p>Select how an IP address is to be assigned to the interface.</p> <p>Possible values:</p> <ul style="list-style-type: none"> • <i>Static</i> (default value): A static IP address is assigned to the interface in IP Address/Netmask. • <i>DHCP</i>: An IP address is assigned to the interface dynamically via DHCP.
IP Address/Netmask	<p>Only if Address Mode = <i>Static</i></p> <p>Enter the IP addresses (IP Address) and the corresponding netmasks (Netmask) of the ATM interfaces. Add new entries with Add.</p>
MAC Address	Enter a MAC address for the internal router interface of ATM

Field	Description
	<p>connection, e.g. <code>00:a0:f9:06:bf:03</code>. An entry is only required in special cases.</p> <p>For Internet connections, it is sufficient to select the Use Pre-configured option (default setting), in which case the MAC address of <code>en1-0</code> is used.</p>
DHCP MAC Address	<p>Only if Address Mode = <i>DHCP</i></p> <p>Enter the MAC address of the internal router interface of ATM connection, e.g. <code>00:e1:f9:06:bf:03</code>.</p> <p>If your provider has assigned you a MAC address for DHCP, enter this here.</p> <p>You can select the Use Pre-configured option (default setting), in which case the MAC address of <code>en1-0</code> is used.</p>
DHCP Hostname	<p>Only if Address Mode = <i>DHCP</i></p> <p>If necessary, enter the host name registered with the provider to be used by your device for DHCP requests.</p> <p>The maximum length of the entry is 45 characters.</p>

Fields in the Settings for Routed Protocols over ATM menu (only shown for Type = Routed Protocols over ATM)

Field	Description
IP Address/Netmask	<p>Enter the IP addresses (IP Address) and the corresponding netmasks (Netmask) of the ATM interface. Add new entries with Add.</p>
Prioritize TCP ACK Packets	<p>Select whether the TCP download is to be optimised in the event of intensive TCP upload. This function can be specially applied for asymmetrical bandwidths (ADSL).</p> <p>The function is activated with <i>Enabled</i>.</p> <p>The function is disabled by default.</p>

Fields in the PPP over ATM Settings menu (only shown for Type = PPP over ATM), see also

Field	Description
Client Type	<p>Select whether the PPPoA connection is to be set up permanently or on demand.</p> <p>Possible values:</p> <ul style="list-style-type: none"> • <i>on demand</i> (default value): The PPPoA is only set up on demand, e.g. for Internet access.

10.2.2 Service Categories

In the **WAN -> ATM -> Service Categories** menu, a list of ATM connections (PVC, Permanent Virtual Circuit) already configured with specific assigned data traffic parameters is shown.

Your device supports QoS (Quality of Service) for ATM interfaces.



Caution

ATM QoS should only be used if your provider specifies a list of data traffic parameters (traffic contract).

The configuration of ATM QoS requires extensive knowledge of ATM technology and the way the **bintec** devices function. An incorrect configuration can cause considerable disruption during operation. If applicable, save the original configuration on your PC.

10.2.2.1 New

Choose the **New** button to set up new categories.

The screenshot shows the configuration interface for a bintec R3800 device. The top navigation bar includes 'Language English', 'Online Help', 'Logout', and the 'funkwerk' logo. The left sidebar contains a tree view with categories like System Management, Physical Interfaces, LAN, Routing, WAN, VPN, Firewall, VoIP, Local Services, Maintenance, External Reporting, and Monitoring. The 'WAN' category is expanded, showing 'Internet + Dialup', 'ATM', and 'Leased Line'. The 'ATM' category is further expanded to show 'Real Time Jitter Control'. The 'Service Categories' tab is selected, and the 'OAM Controlling' sub-tab is active. The main content area displays a 'Basic Parameters' form with the following fields:

Basic Parameters	
Virtual Channel Connection (VCC)	VPI8, VCI32
ATM Service Category	Select one
Peak Cell Rate (PCR)	0 bps
Sustained Cell Rate (SCR)	0 bps
Maximum Burst Size (MBS)	0 bps

At the bottom of the form are 'OK' and 'Cancel' buttons.

Fig. 121: WAN -> ATM -> Service Categories-> New

The WAN -> ATM -> Service Categories-> New menu consists of the following fields:

Fields in the ATM Service Categories menu

Field	Description
Virtual Channel Connection (VCC)	Select the already configured ATM connection (displayed by the combination of VPI and VCI) for which the service category is to be defined.
ATM Service Category	<p>Select how the data traffic of the ATM connection is to be controlled.</p> <p>When you select the ATM service category a priority is implicitly assigned: from CBR (highest priority) through VBR.1 /VBR.3 to VBR (lowest priority).</p> <p>Possible settings:</p> <ul style="list-style-type: none"> • <i>Unspecified Bit Rate (UBR)</i> (default value): (Unspecified Bit Rate) A particular data rate is not guaranteed for the connection. The Peak Cell Rate (PCR) defines the limit above which data is discarded. This category is suitable for non-critical applications. • <i>Constant Bit Rate (CBR)</i>: (Constant Bit Rate) The connection is assigned a guaranteed data rate determined by the Peak Cell Rate (PCR). This category is suitable for critical (real-time) applications that require a guaranteed data rate.

Field	Description
	<ul style="list-style-type: none"> • <i>Variable Bit Rate V.1 (VBR.1)</i> : (Variable Bit Rate) The connection is assigned a guaranteed data rate (Sustained Cell Rate (SCR)). This may be exceeded by the volume configured in Maximum Burst Size. Any additional ATM traffic is discarded. The Peak Cell Rate (PCR) represents the maximum possible data rate. This category is suitable for non-critical applications with burst data traffic. • <i>Variable Bit Rate V.3 (VBR.3)</i> : (Variable Bit Rate) The connection is assigned a guaranteed data rate (Sustained Cell Rate (SCR)). This may be exceeded by the volume configured in Maximum Burst Size (MBS). Additional ATM traffic is marked and handled with low priority based on the utilisation of the destination network, i.e. is discarded if necessary. The Peak Cell Rate (PCR) represents the maximum possible data rate. This category is suitable for critical applications with burst data traffic.
Peak Cell Rate (PCR)	<p>Enter a value for the maximum data rate in bits per second.</p> <p>Possible values: 0 to 10000000.</p> <p>The default value is 0.</p>
Sustained Cell Rate (SCR)	<p>Only for ATM Service Category = <i>Variable Bit Rate V.1 (VBR.1)</i> or <i>Variable Bit Rate V.3 (VBR.3)</i></p> <p>Enter a value for the minimum available, guaranteed data rate in bits per second.</p> <p>Possible values: 0 to 10000000.</p> <p>The default value is 0.</p>
Maximum burst size (MBS)	<p>Only for ATM Service Category = <i>Variable Bit Rate V.1 (VBR.1)</i> or <i>Variable Bit Rate V.3 (VBR.3)</i></p> <p>Enter a value for the maximum number of bits per second by which the PCR can be exceeded briefly.</p> <p>Possible values: 0 to 100000.</p> <p>The default value is 0.</p>

10.2.3 OAM Controlling

OAM is a service for monitoring ATM connections. A total of five hierarchies (flow level F1 to F5) are defined for OAM information flow. The most important information flows for an ATM connection are F4 and F5. The F4 information flow concerns the virtual path (VP) and the F5 information flow the virtual channel (VC). The VP is defined by the VPI value, the VC by VPI and VCI.



Note

Generally, monitoring is not carried out by the terminal but is initiated by the ISP. Your device then only needs to react correctly to the signals received. This is ensured without a specific OAM configuration for both flow level 4 and flow level 5.

Two mechanisms are available for monitoring the ATM connection: Loopback Tests and OAM Continuity Check (OAM CC). These can be configured independently of each other.



Caution

The configuration of OAM requires extensive knowledge of ATM technology and the way the **bintec** devices functions. An incorrect configuration can cause considerable disruption during operation. If applicable, save the original configuration on your PC.

In the **WAN -> ATM -> OAM Control** menu, a list of all monitored OAM flow levels is shown.

10.2.3.1 New

Choose the **New** button to set up monitoring for other flow levels.

The screenshot shows the configuration interface for a bintec R3800 device. The left sidebar contains a navigation menu with categories like System Management, Physical Interfaces, LAN, Routing, WAN, ATM, Leased Line, Real Time Jitter Control, VPN, Firewall, VoIP, Local Services, Maintenance, External Reporting, and Monitoring. The main area is titled 'OAM Controlling' and contains the following configuration fields:

- OAM Flow Configuration**
 - OAM Flow Level: F5 (dropdown)
 - Virtual Channel Connection (VCC): VPI8, VCI32 (dropdown)
- Loopback**
 - Loopback End-to-End: Enabled
 - Loopback Segment: Enabled
- CC Activation**
 - Continuity Check (CC) End-to-End:
 - Passive (dropdown)
 - Direction: Both (dropdown)
 - Continuity Check (CC) Segment:
 - Passive (dropdown)
 - Direction: Both (dropdown)

At the bottom of the configuration area are 'OK' and 'Cancel' buttons.

Fig. 122: WAN -> ATM -> OAM Control-> New

The WAN -> ATM -> OAM Control-> New menu consists of the following fields:

Fields in the OAM Control OAM Flow Configuration

Field	Description
OAM Flow Level	Select the OAM flow level to be monitored. Possible values: <ul style="list-style-type: none"> ƒ5 : (virtual channel level) The OAM settings are used for the virtual channel (default value). ƒ4 : (virtual path level) The OAM settings are used for the virtual path.
Virtual Channel Connection (VCC)	Only for OAM Flow Level = ƒ5 Select the already configured ATM connection to be monitored (displayed by the combination of VPI and VCI).
Virtual Path Connection (VPC)	Only for OAM Flow Level = ƒ4 Select the already configured virtual path connection to be monitored (displayed by the VPI).

Fields in the OAM Control Loopback

Field	Description
Loopback End-to-End	<p>Select whether you activate the loopback test for the connection between the endpoints of the VCC or VPC.</p> <p>The function is activated with <i>Enabled</i>.</p> <p>The function is disabled by default.</p>
End-to-End Send Interval	<p>Only if Loopback End-to-End is enabled.</p> <p>Enter the time in seconds after which a loopback cell is to be sent.</p> <p>Possible values are 0 to 999.</p> <p>The default value is 5.</p>
End-to-End Pending Requests	<p>Only if Loopback End-to-End is enabled.</p> <p>Enter the number of directly consecutive loopback cells that may fail to materialise before the connection is regarded as interrupted ("down"). Possible values are 1 to 99.</p> <p>The default value is 5.</p>
Loopback Segment	<p>Select whether you want to activate the loopback test for the segment connection (segment = connection of the local endpoint to the next connection point) of the VCC or VPC.</p> <p>The function is activated with <i>Enabled</i>.</p> <p>The function is disabled by default.</p>
Segment Send Interval	<p>Only if Loopback Segment is enabled.</p> <p>Enter the time in seconds after which a loopback cell is sent.</p> <p>Possible values are 0 to 999.</p> <p>The default value is 5.</p>
Segment Pending Requests	<p>Only if Loopback Segment is enabled.</p> <p>Enter the number of directly consecutive loopback cells that may fail to materialise before the connection is regarded as interrupted ("down").</p>

Field	Description
	<p>Possible values are 1 to 99.</p> <p>The default value is 5.</p>

Fields in the OAM Control CC Activation

Field	Description
Continuity Check (CC) End-to-End	<p>Select whether you activate the OAM-CC test for the connection between the endpoints of the VCC or VPC.</p> <p>Possible values:</p> <ul style="list-style-type: none"> • <i>Passive</i> (default value) OAM CC requests are responded to after CC negotiation (CC activation negotiation). • <i>Active</i>: OAM CC requests are sent after CC negotiation (CC activation negotiation). • <i>Both</i>: OAM CC requests are sent and answered after CC negotiation (CC activation negotiation). • <i>No Negotiation</i>: Depending on the setting in the Direction field, OAM CC requests are either sent and/or responded to. There is no CC negotiation. • <i>None</i>: The function is disabled. <p>Also select whether the test cells of the OAM CC are to be sent or received.</p> <p>Possible values:</p> <ul style="list-style-type: none"> • <i>Both</i> (default value): CC data is both received and generated. • <i>Sink</i>: CC data is received. • <i>Source</i>: CC data is generated. • <i>None</i>: The function is disabled.
Continuity Check (CC) Segment	<p>Select whether you want to activate the OAM-CC test for the segment connection (segment = connection of the local endpoint to the next connection point) of the VCC or VPC.</p> <p>Possible values:</p> <ul style="list-style-type: none"> • <i>Passive</i> (default value) OAM CC requests are responded to after CC negotiation (CC activation negotiation). • <i>Active</i>: OAM CC requests are sent after CC negotiation (CC

Field	Description
	<p>activation negotiation).</p> <ul style="list-style-type: none"> • <i>Both</i>: OAM CC requests are sent and answered after CC negotiation (CC activation negotiation). • <i>No Negotiation</i>: Depending on the setting in the Direction field, OAM CC requests are either sent and/or responded to. There is no CC negotiation. • <i>None</i>: The function is disabled. <p>Also select whether the test cells of the OAM CC are to be sent or received.</p> <p>Possible settings:</p> <ul style="list-style-type: none"> • <i>Both</i> (default value): CC data is both received and generated. • <i>Sink</i>: CC data is received. • <i>Source</i>: CC data is generated. • <i>None</i>: The function is disabled.

10.3 Leased line

A leased line is a permanent (fixed) connection between two communication partners via a telecommunications network. Unlike a switched line, the entire transmission channels is always available. The leased line cannot be set up by the subscriber by dialling and therefore has no call number. The connection must be set up by the network operator.

10.3.1 Interfaces

In the **WAN -> Leased Line -> Interfaces** menu, a list of all automatically generated leased line connections is shown. Automatic generation requires the corresponding ISDN interface to be configured.

The screenshot shows the 'bintec R4100' web interface. The top navigation bar includes 'Language English', 'Online Help', 'Logout', and the 'funkwerk' logo. The left sidebar contains a menu with 'WAN' expanded to 'Leased Line'. The main content area is titled 'Interfaces' and displays three tables of automatically generated interfaces.

Autogenerated from BRI (ISDN-S0)						
Description	Type	Protocol	Port	Status	Action	
Autogenerated from PRI (ISDN-S2M)						
Description	Type	Protocol	Port	Status	Action	
Autogenerated from Serial						
Description	Type	Protocol	Port	Status	Action	
si4-0	None	PPP		⚠	↑ ↓	🔄
si4-1	None	PPP		⚠	↑ ↓	🔄

Fig. 123: **WAN -> Leased Line -> Interfaces**

10.3.1.1 Edit

Choose the  button to edit the configuration of the corresponding leased line.

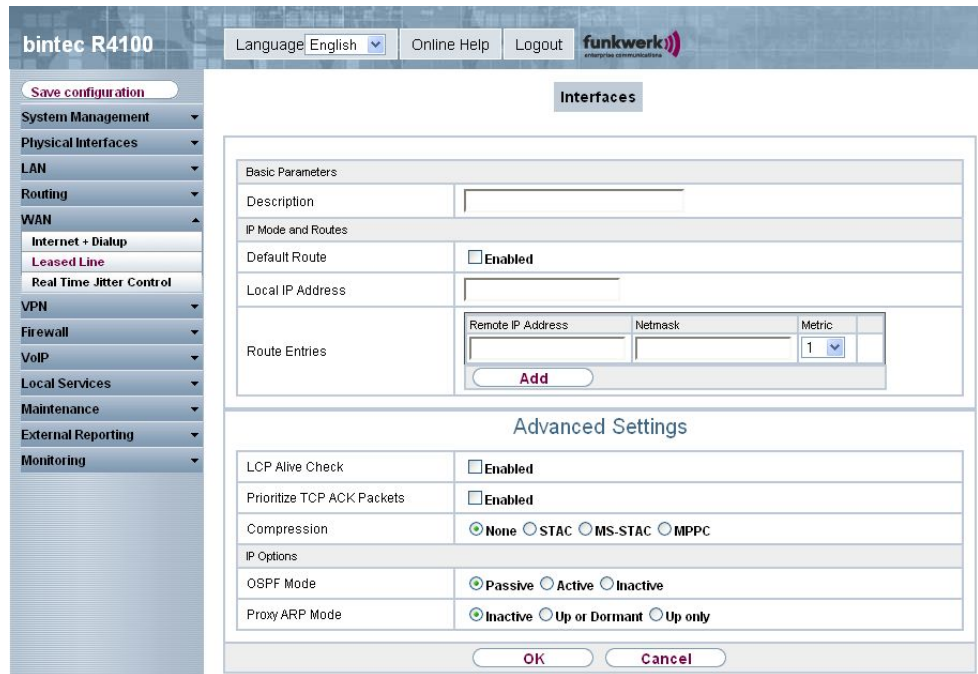

The screenshot shows the configuration page for a WAN Leased Line. The left sidebar contains a navigation menu with categories like System Management, Physical Interfaces, LAN, Routing, WAN, VPN, Firewall, VoIP, Local Services, Maintenance, External Reporting, and Monitoring. The main content area is titled 'Interfaces' and is divided into two sections: 'Basic Parameters' and 'Advanced Settings'.

Basic Parameters:

- Description: [Text input field]
- IP Mode and Routes:
 - Default Route: Enabled
 - Local IP Address: [Text input field]
- Route Entries:

Remote IP Address	Netmask	Metric
[Text input field]	[Text input field]	1

Advanced Settings:

- LCP Alive Check: Enabled
- Prioritize TCP ACK Packets: Enabled
- Compression: None STAC MS-STAC MPPC
- IP Options:
 - OSPF Mode: Passive Active Inactive
 - Proxy ARP Mode: Inactive Up or Dormant Up only

Buttons for 'Add', 'OK', and 'Cancel' are visible at the bottom of the configuration area.

Fig. 124: WAN -> Leased Line -> Interfaces-> Autogenerated from BRI (ISDN-S0) -> 

The WAN -> Leased Line -> Interfaces-> Autogenerated from BRI (ISDN-S0) ->  menu consists of the following fields:

Fields in the Leased Line Basic Parameters menu

Field	Description
Description	Enter the desired description for the connection.

Fields in the Interfaces IP Mode and Routes menu

Field	Description
Default Route	Select whether the route to this connection partner is to be defined as the default route. The function is activated with <i>Enabled</i> . The function is disabled by default.
Local IP Address	Enter the IP address you received from your network operator.

Field	Description
Route Entries	<p>Define other routing entries for this connection class.</p> <p>Add a new entry with Add.</p>

The **Advanced Settings** menu consists of the following fields:

Fields in the Advanced Settings menu

Field	Description
LCP Alive Check	<p>Select whether the availability of the remote terminal is to be checked.</p> <p>The function is activated with <i>Enabled</i>.</p> <p>The function is disabled by default.</p>
Prioritize TCP ACK Packets	<p>Select whether the TCP download is to be optimised in the event of intensive TCP upload.</p> <p>The function is activated with <i>Enabled</i>.</p> <p>The function is disabled by default.</p>
Compression	<p>If necessary, select the type of encryption that should be used for data traffic to the connection partner. If encryption is set, the remote terminal must also support it, otherwise a connection cannot be set up.</p> <p>Possible values:</p> <ul style="list-style-type: none"> • <i>None</i> (default value): Encryption is not used. • <i>STAC</i> • <i>MS-STAC</i> • <i>MPPC</i>: Microsoft Point-to-Point Compression

Fields in the Advanced Settings IP Options menu

Field	Description
OSPF Mode	<p>Specify whether OSPF protocol packets are sent over the interface.</p> <p>Possible values:</p> <ul style="list-style-type: none"> • <i>Passive</i> (default value) OSPF is not activated for this interface, i.e. no OSPF protocol packets sent over this interface.

Field	Description
	<p>Networks reachable over this interface are, however, included when calculating the routing information and propagated over active interfaces.</p> <ul style="list-style-type: none">• <i>Active</i>: OSPF is not activated for this interface, i.e. OSPF protocol packets sent over this interface.• <i>Down</i> : OSPF is disabled for this interface.
Proxy ARP Mode	<p>Select whether and how ARP requests are to be responded to for the specified connection partner.</p> <p>Possible values:</p> <ul style="list-style-type: none">• <i>Inactive</i> (default value): Deactivates Proxy ARP for this connection partner.• <i>Active or Idle</i>: Your device only responds to an ARP request if the status of the connection to the connection partner is <i>Up</i> or <i>Dormant</i>. In the case of <i>Idle</i>, your device only responds to the ARP request; the connection is not set up until someone actually wants to use the route.• <i>Active Only</i>: Your device responds to an ARP request only if the status of the connection to the connection partner is <i>Up</i> (active), i.e. a connection already exists to the connection partner.

Fig. 125: WAN -> Leased Line -> Interfaces-> Autogenerated from PRI (ISDN-S2M) ->

The WAN -> Leased Line -> Interfaces-> Autogenerated from PRI (ISDN-S2M) -> menu consists of the following fields:

Fields in the Interfaces Basic Parameters menu

Field	Description
Description	Enter the desired description for the connection.

Fields in the Interfaces IP Mode and Routes menu

Field	Description
Default Route	Select whether the route to this connection partner is to be defined as the default route. The function is activated with <i>Enabled</i> . The function is disabled by default.
Local IP Address	Enter the IP address you received from your network operator.
Route Entries	Define other routing entries for this connection class. Add a new entry with Add .

The **Advanced Settings** menu consists of the following fields:

Fields in the Advanced Settings menu

Field	Description
LCP Alive Check	<p>Select whether the availability of the remote terminal is to be checked.</p> <p>The function is activated with <i>Enabled</i>.</p> <p>The function is disabled by default.</p>
Prioritize TCP ACK Packets	<p>Select whether the TCP download is to be optimised in the event of intensive TCP upload.</p> <p>The function is activated with <i>Enabled</i>.</p> <p>The function is disabled by default.</p>
Compression	<p>If necessary, select the type of encryption that should be used for data traffic to the connection partner. If encryption is set, the remote terminal must also support it, otherwise a connection cannot be set up.</p> <p>Possible values:</p> <ul style="list-style-type: none"> • <i>None</i> (default value): Encryption is not used. • <i>STAC</i> • <i>MS-STAC</i> • <i>MPPC</i>: Microsoft Point-to-Point Compression

Fields in the Advanced Settings IP Options menu

Field	Description
OSPF Mode	<p>Specify whether OSPF protocol packets are sent over the interface.</p> <p>Possible values:</p> <ul style="list-style-type: none"> • <i>Passive</i> (default value) OSPF is not activated for this interface, i.e. no OSPF protocol packets sent over this interface. Networks reachable over this interface are, however, included when calculating the routing information and propagated over active interfaces. • <i>Active</i>: OSPF is not activated for this interface, i.e. OSPF

Field	Description
	<p>protocol packets sent over this interface.</p> <ul style="list-style-type: none"> <i>Down</i> : OSPF is disabled for this interface.
Proxy ARP Mode	<p>Select whether and how ARP requests are to be responded to for the specified connection partner.</p> <p>Possible values:</p> <ul style="list-style-type: none"> <i>Inactive</i> (default value): Deactivates Proxy ARP for this connection partner. <i>Active or Idle</i>: Your device only responds to an ARP request if the status of the connection to the connection partner is <i>Up</i> or <i>Dormant</i>. In the case of <i>Idle</i>, your device only responds to the ARP request; the connection is not set up until someone actually wants to use the route. <i>Active Only</i>: Your device responds to an ARP request only if the status of the connection to the connection partner is <i>Up</i> (active), i.e. a connection already exists to the connection partner.

The screenshot shows the web interface for a bintec R4300 device. The top navigation bar includes 'Language English', 'Online Help', 'Logout', and the 'funkwerk' logo. A left sidebar contains a menu with categories like 'System Management', 'Physical Interfaces', 'LAN', 'Routing', 'WAN', 'VPN', 'Firewall', 'VoIP', 'Local Services', 'Maintenance', 'External Reporting', and 'Monitoring'. The 'WAN' section is expanded, showing 'Internet + Dialup', 'Leased Line', and 'Real Time Jitter Control'. The main content area is titled 'Interfaces' and displays configuration for a specific interface with the following sections:

- Basic Parameters:** Description: 's14-0'.
- IP Mode and Routes:** Default Route: Enabled.
- Local IP Address:** (Empty field)
- Route Entries:** A table with columns for Remote IP Address, Netmask, and Metric. The Metric is set to 1. An 'Add' button is present below the table.
- Advanced Settings:**
 - LCP Alive Check: Enabled
 - Prioritize TCP ACK Packets: Enabled
 - Compression: None STAC MS-STAC MPPC
 - IP Options: OSPF Mode: Passive Active Inactive
 - Proxy ARP Mode: Inactive Up or Dormant Up only

At the bottom of the configuration area are 'OK' and 'Cancel' buttons.

Fig. 126: WAN -> Leased Line -> Interfaces-> Autogenerated from Serial -> 

The **WAN -> Leased Line -> Interfaces-> Autogenerated from Serial** ->  menu consists of the following fields:

Fields in the Interfaces Basic Parameters menu

Field	Description
Description	Enter the desired description for the connection.

Fields in the Interfaces IP Mode and Routes menu

Field	Description
Default Route	Select whether the route to this connection partner is to be defined as the default route. The function is activated with <i>Enabled</i> . The function is disabled by default.
Local IP Address	Enter the IP address you received from your network operator.
Route Entries	Define other routing entries for this connection class. Add a new entry with Add .

The **Advanced Settings** menu consists of the following fields:

Fields in the Advanced Settings menu

Field	Description
LCP Alive Check	Select whether the availability of the remote terminal is to be checked. The function is activated with <i>Enabled</i> . The function is disabled by default.
Prioritize TCP ACK Packets	Select whether the TCP download is to be optimised in the event of intensive TCP upload. The function is activated with <i>Enabled</i> . The function is disabled by default.

Fields in the Advanced Settings IP Options menu

Field	Description
OSPF Mode	Specify whether OSPF protocol packets are sent over the inter-

Field	Description
	<p>face.</p> <p>Possible values:</p> <ul style="list-style-type: none"> • <i>Passive</i> (default value) OSPF is not activated for this interface, i.e. no OSPF protocol packets sent over this interface. Networks reachable over this interface are, however, included when calculating the routing information and propagated over active interfaces. • <i>Active</i>: OSPF is not activated for this interface, i.e. OSPF protocol packets sent over this interface. • <i>Down</i> : OSPF is disabled for this interface.
Proxy ARP Mode	<p>Select whether and how ARP requests are to be responded to for the specified connection partner.</p> <p>Possible values:</p> <ul style="list-style-type: none"> • <i>Inactive</i> (default value): Deactivates Proxy ARP for this connection partner. • <i>Active or Idle</i>: Your device only responds to an ARP request if the status of the connection to the connection partner is <i>Up</i> or <i>Dormant</i>. In the case of <i>Idle</i>, your device only responds to the ARP request; the connection is not set up until someone actually wants to use the route. • <i>Active Only</i>: Your device responds to an ARP request only if the status of the connection to the connection partner is <i>Up</i> (active), i.e. a connection already exists to the connection partner.

10.4 Real Time Jitter Control

When telephoning over the Internet, voice data packets normally have the highest priority. Nevertheless, if the upstream bandwidth is low, noticeable delays in voice transmission can occur when other packets are routed at the same time.

The real time jitter control function solves this problem. So that the "line" is not blocked for too long for the voice data packets, the size of the other packets can be reduced, if required, during a telephone call.

10.4.1 Controlled interfaces

In the **WAN -> Real Time Jitter Control ->Controlled Interfaces** menu, a list of all interfaces is shown for which the real time jitter control has been configured.

10.4.1.1 New

Click o the **New** button to set up portforwarding for other interfaces.

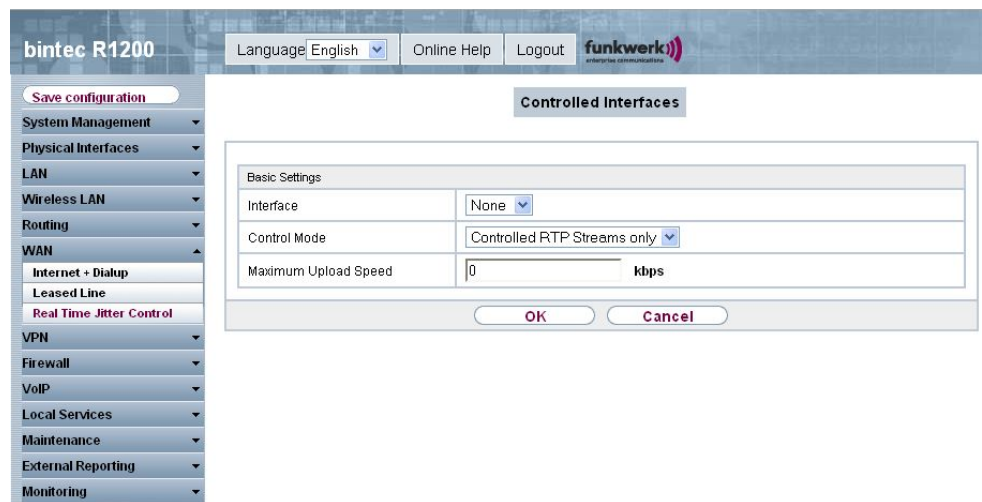

Fig. 127: **WAN -> Real Time Jitter Control-> Controlled Interfaces-> New**

The **WAN -> Real Time Jitter Control -> Controlled Interfaces -> New** menu consists of the following fields:

Fields in the Real Time Jitter Control Basic Settings menu

Field	Description
Interface	Define for which interfaces voice transmission is to be optimised.
Control Mode	Select the mode for the optimisation. Possible values: <ul style="list-style-type: none"> <i>Controlled RTP Streams only</i> (default value): By means of the data routed via the media gateway, the system detects voice data traffic and optimises the voice transmission.

Field	Description
	<ul style="list-style-type: none">• <i>All RTP Streams</i>: All RTP streams are optimised.• <i>Inaktive</i> : Voice data transmission is not optimised.• <i>Always</i>: Voice data transmission is always optimised.
Maximum Upload Speed	Enter the maximum available upstream bandwidth in kbps for the selected interface.

Chapter 11 VPN

11.1 IPSec

IPSec enables secure connections to be set up between two locations (VPN). This enables sensitive business data to be transferred via an unsecure medium such as the Internet. The devices use function here as the endpoints of the VPN tunnel. IPSec involves a number of Internet Internet Engineering Task Force (IETF) standards, which specify mechanisms for the protection and authentication of IP packets. IPSec offers mechanisms for encrypting and decrypting the data transferred in the IP packets. The IPSec implementation can also be smoothly integrated in a Public Key Infrastructure (PKI). The funkwerk IPSec implementation achieves this firstly by using the Authentication Header (AH) protocol and Encapsulated Security Payload (ESP) protocol, and secondly through the use of cryptographic key key administration mechanisms like the Internet Key Exchange (IKE) protocol.

11.1.1 IPSec Peers

An endpoint of a communication is defined as peer in a computer network. Each peer offers its services and uses the services of other peers.

In the **VPN -> IPSec -> IPSec Peers** menu a list of all configured IPSec peers is shown.

The screenshot shows the web interface for a bintec R1200 device. The top bar includes 'Language English', 'Online Help', 'Logout', and the 'funkwerk' logo. The left sidebar contains a navigation menu with categories like 'System Management', 'Physical Interfaces', 'LAN', 'Wireless LAN', 'Routing', 'WAN', 'VPN', 'Firewall', 'VoIP', 'Local Services', 'Maintenance', 'External Reporting', and 'Monitoring'. The 'VPN' category is expanded, showing 'IPSec' as the selected option. The main content area is titled 'IPSec Peers' and includes sub-tabs for 'Phase-1 Profiles', 'Phase-2 Profiles', 'IP Pools', and 'Options'. Below the tabs is a table with columns for 'Prio', 'Description', 'Peer Address', 'Peer ID', 'Phase-1 Profile', 'Phase-2 Profile', and 'Status'. The table is currently empty. Above the table is a search and pagination area with 'View 10 per page', 'Filter in None', and 'equal' dropdowns. A 'Go' button is next to the search area. Below the table is a 'New' button.

Fig. 128: VPN -> IPSec -> IPSec Peers

Peer Monitoring

The menu for monitoring a peer is called by selecting the  button for the peer in the peer list. See *Values in the list IPsec Tunnels* on page 491.

11.1.1.1 New

Choose the **New** button to set up more IPsec peers.

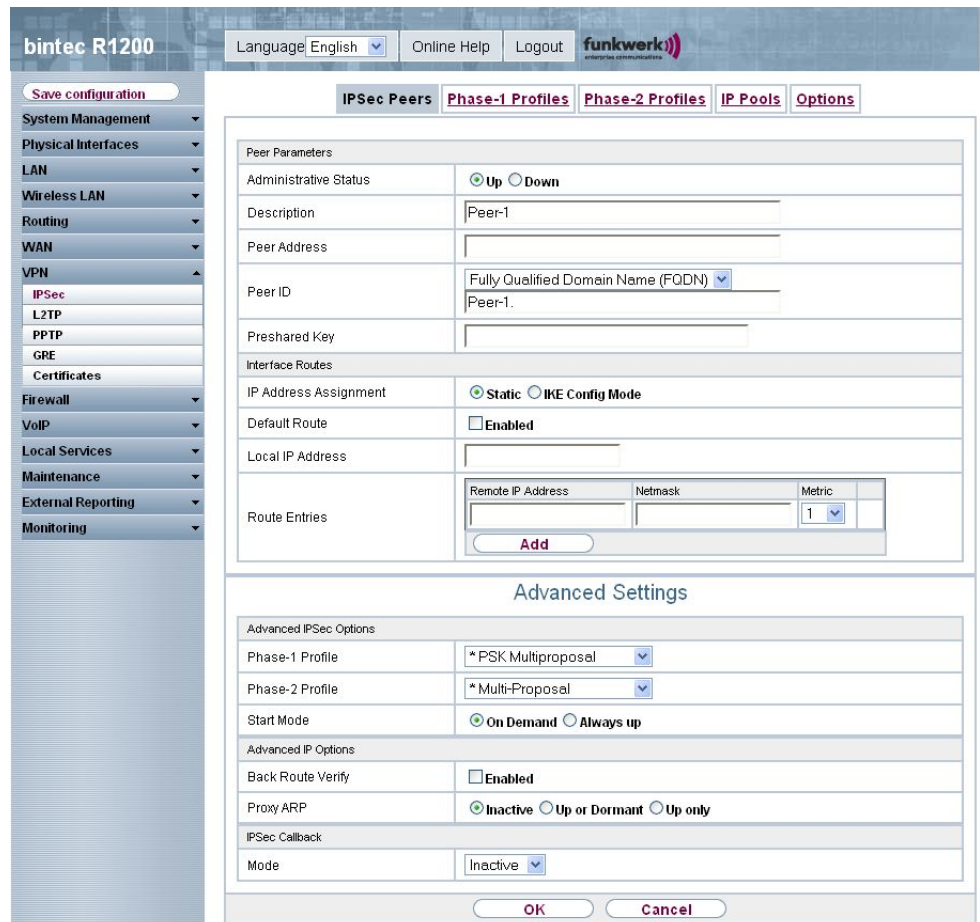

bintec R1200 Language English Online Help Logout 

Save configuration

System Management
Physical Interfaces
LAN
Wireless LAN
Routing
WAN
VPN
IPsec
L2TP
PPTP
GRE
Certificates
Firewall
VoIP
Local Services
Maintenance
External Reporting
Monitoring

IPsec Peers Phase-1 Profiles Phase-2 Profiles IP Pools Options

Peer Parameters

Administrative Status Up Down

Description Peer-1

Peer Address

Peer ID Fully Qualified Domain Name (FQDN) Peer-1.

Preshared Key

Interface Routes

IP Address Assignment Static IKE Config Mode

Default Route Enabled

Local IP Address

Remote IP Address	Netmask	Metric
		1

Route Entries

Advanced Settings

Advanced IPsec Options

Phase-1 Profile *PSK Multiproposal

Phase-2 Profile *Multi-Proposal

Start Mode On Demand Always up

Advanced IP Options

Back Route Verify Enabled

Proxy ARP Inactive Up or Dormant Up only

IPsec Callback

Mode Inactive

Fig. 129: VPN -> IPsec ->IPsec Peers-> New

The VPN -> IPsec -> IPsec Peers-> New menu consists of the following fields:

Fields in the IPsec Peers Peer Parameters menu

Field	Description
Administrative Status	<p>Select the status to which you wish to set the peer after saving the peer configuration.</p> <p>Possible values:</p> <ul style="list-style-type: none"> • <i>UP</i> (default value): The peer is available for setting up a tunnel immediately after saving the configuration. • <i>Down</i>: The peer is initially not available after the configuration has been saved.
Description	<p>Enter a description of the peer that identifies it.</p> <p>The maximum length of the entry is 255 characters.</p>
Peer Address	<p>Enter the official IP address of the peer or its resolvable host name.</p> <p>The entry can be omitted in certain configurations, whereby your device then cannot initiate an IPSec connection.</p>
Peer ID	<p>Select the ID type and enter the peer ID.</p> <p>This entry is not necessary in certain configurations.</p> <p>The maximum length of the entry is 255 characters.</p> <p>Possible ID types:</p> <ul style="list-style-type: none"> • <i>Fully Qualified Domain Name (FQDN)</i> • <i>E-mail address</i> • <i>IPV4 Address</i> • <i>ASN.1 DN (Distinguished Name)</i> <p>On the peer device, this ID corresponds to the parameter Local ID Value.</p>
Preshared Key	<p>Enter the password agreed with the peer.</p> <p>The maximum length of the entry is 50 characters. All characters are possible except for <i>0x</i> at the start of the entry.</p>

Fields in the IPSec Peers Interface Routes menu

Field	Description
IP Address Assignment	<p>Select the configuration mode of the interface.</p> <p>Possible values:</p> <ul style="list-style-type: none"> • <i>Static</i> (default value): Enter a static IP address. • <i>IKE Config Mode</i>: Choose an IP address from the configured IP pool.
IP Assignment Pool	<p>Only if IP Address Assignment = <i>IKE Config Mode</i></p> <p>Select an IP pool configured in the VPN -> IP Pools menu. If an IP pool has not been configured here yet, the message <i>Not yet defined</i> appears in this field.</p>
Default Route	<p>Only for IP Address Assignment = <i>Static</i></p> <p>Select whether the route to this IPSec peer is to be defined as the default route.</p> <p>The function is activated with <i>Enabled</i>.</p> <p>The function is disabled by default.</p>
Local IP Address	<p>Only if Standard Route is <i>not enabled</i>.</p> <p>Enter the WAN IP address of your IPSec connection. It could be the same as a LAN IP address configured at this router.</p>
Route Entries	<p>Define routing entries for this connection partner.</p> <ul style="list-style-type: none"> • <i>Remote IP Address</i>: IP address of the destination host or LAN. • <i>Netmask</i>: Netmask for Destination IP Address. • <i>Metric</i>: The lower the value, the higher the priority of the route (possible values 0 . . . 15). The default value is 1.

The **Advanced Settings** menu consists of the following fields:

Fields in the Advanced Settings Advanced IPSec Options menu

Field	Description
Phase-1 Profile	<p>For phase 1, select a profile already configured in the Phase-1 Profiles menu. You can also select the profile marked as the default in Phase-1 Profiles: <i>None (use Default)</i></p>

Field	Description
Phase-2 Profile	For phase 2, select a profile already configured in the Phase-2 Profiles menu. You can also select the profile marked as the default in Phase-2 Profiles: None (use Default Profile) .
Start mode	Select how the peer is to be switched to the active state. Possible values: <ul style="list-style-type: none"> • <i>On demand</i> (default value): The peer is switched to the active state by a trigger. • <i>Always on</i>: The peer is always active.

Fields in the Advanced Settings Advanced IP Options menu

Field	Description
Back Route Verify	Select whether a check on the back route should be activated for the interface to the connection partner. The function is activated with <i>Enabled</i> . The function is disabled by default.
Proxy ARP	Select whether your device is to respond to ARP requests from its own LAN on behalf of the specific connection partner. Possible values: <ul style="list-style-type: none"> • <i>Inactive</i> (default value): Deactivates Proxy ARP for this IPsec peer. • <i>Up or Dormant</i>: Your device only responds to an ARP request if the status of the connection to the IPsec peer is <i>Up</i> (active) or <i>Dormant</i>. In the case of <i>Idle</i>, your device only responds to the ARP request; the connection is not set up until someone actually wants to use the route. • <i>Active Only</i>: Your device responds to an ARP request only if the status of the connection to the IPsec peer is <i>Up</i> (active), i.e. a connection already exists to the IPsec peer.

IPsec Callback

bintec devices support the DynDNS service to enable hosts without fixed IP addresses to obtain a secure connection over the Internet. This service enables a peer to be identified using a host name that can be resolved by DNS. You do not need to configure the IP address of the peer.

The DynDNS service does not signal whether a peer is actually online and cannot cause a peer to set up an Internet connection to enable an IPSec tunnel over the Internet. This possibility is created with IPSec callback: Using a direct ISDN call to a peer, you can signal that you are online and waiting for the peer to set up an IPSec tunnel over the Internet. If the called peer currently has no connection to the Internet, the ISDN call causes a connection to be set up. This ISDN call costs nothing (depending on country), as it does not have to be accepted by your device. The identification of the caller from his or her ISDN number is enough information to initiate setting up a tunnel.

Before you can configure this service, you must first configure a number for IPSec callback on the passive page in the **Physical Interfaces -> ISDN Ports -> MSN Configuration -> New** menu. The value *IPSec* is available for this purpose in the **Service** field. This entry ensures that incoming calls for this number are routed to the IPSec service.

If callback is active, the peer is caused to initiate setting up an IPSec tunnel by an ISDN call as soon as this tunnel is required. With passive callback, the set-up of a tunnel to the peer is always initiated if an ISDN call to the corresponding number (**MSN** in the **Physical Interfaces -> ISDN Ports -> MSN Configuration -> New** for **Service** *IPSec* menu) is received. This ensures that both peers are reachable and that the connection can be set up over the Internet. The only case in which callback is not executed is if SAs (Security Associations) already exist, i.e. the tunnel to the peer already exists.



Note

If a tunnel is to be set up to a peer, the interface over which the tunnel is to be implemented is activated first by the IPSec Daemon. If IPSec with DynDNS is configured on the local device, the own IP address is propagated first and then the ISDN call is sent to the remote device. This ensures that the remote device can actually reach the local device if it initiates the tunnel setup.

Transfer of IP Address over ISDN

Transferring the IP address of a device over ISDN (in the D channel and/or B channel) opens up new possibilities for the configuration of IPSec VPNs. This enables restrictions that occur in IPSec configuration with dynamic IP addresses to be avoided.

**Note**

To use the IP address transfer over ISDN function, you must obtain a free-of-charge extra licence.

You can obtain the licence data for extra licences via the online licensing pages in the support section at www.funkwerk-ec.com. Please follow the online licensing instructions.

Before System Software Release 7.1.4, IPsec ISDN callback only supported tunnel setup if the current IP address of the initiator could be determined by indirect means (e.g. via DynDNS). However, DynDNS has serious disadvantages, such as the latency until the IP address is actually updated in the database. This can mean that the IP address propagated via DynDNS is not correct. This problem is avoided by transferring the IP address over ISDN. This type of transfer of dynamic IP addresses also enables the more secure ID Protect mode (main mode) to be used for tunnel setup.

Method of operation: Various modes are available for transferring your own IP address to the peer: The address can be transferred free in the D channel or in the B channel, but here the call must be accepted by the remote station and therefore incurs costs. If a peer whose IP address has been assigned dynamically wants to arrange for another peer to set up an IPsec tunnel, it can transfer its own IP address as per the settings described in *Fields in the Advanced Settings IPsec Callback menu* on page 320. Not all transfer modes are supported by all telephone companies. If you are not sure, automatic selection by the device can be used to ensure that all the available possibilities can be used.

**Note**

The callback configuration on the two devices should be the same so your device of the called peer can identify the IP address information.

The following roles are possible:

- One side takes on the active role, the other the passive role.
- Both sides can take on both roles (both).

The IP address transfer and the start of IKE phase 1 negotiation take place in the following steps:

- (1) Peer A (the callback initiator) sets up a connection to the Internet in order to be assigned a dynamic IP address and be reachable for peer B over the Internet.
- (2) Your device creates a token with a limited validity and saves it together with the current IP address in the MIB entry belonging to peer B.

- (3) Your device sends the initial ISDN call to peer B, which transfers the IP address of peer A and the token as per the callback configuration.
- (4) Peer B extracts the IP address of peer A and the token from the ISDN call and assigns them to peer A based on the calling party number configured (the ISDN number used by peer A to send the initial call to peer B).
- (5) The IPsec Daemon at peer B's device can use the transferred IP address to initiate phase 1 negotiation with peer A. Here the token is returned to peer A in part of the payload in IKE negotiation.
- (6) Peer A is now able to compare the token returned by peer B with the entries in the MIB and so identify the peer without knowing its IP address.

As peer A and peer B can now mutually identify each other, negotiations can also be conducted in the ID Protect mode using preshared keys.



Note

In some countries (e.g. Switzerland), the call in the D channel can also incur costs. An incorrect configuration at the called side can mean that the called side opens the B channel the calling side incurs costs.

Fields in the Advanced Settings IPsec Callback menu

Field	Description
Mode	<p>Select the Callback Mode.</p> <p>Possible values:</p> <ul style="list-style-type: none"> • <i>Inactive</i> (default value): IPsec callback is deactivated. The local device neither reacts to incoming ISDN calls nor initiates ISDN calls to the remote device. • <i>Passive</i>: The local device only reacts to incoming ISDN calls and, if necessary, initiates setting up an IPsec tunnel to the peer. No ISDN calls are sent to the remote device to cause this to set up an IPsec tunnel. • <i>Active</i>: The local device sends an ISDN call to the remote device to cause this to set up an IPsec tunnel. The device does not react to incoming ISDN calls. • <i>Both</i>: Your device can react to incoming ISDN calls and send ISDN calls to the remote device. The setting up of an IPsec tunnel is executed (after an incoming ISDN call) and initiated (by an outgoing ISDN call).

Field	Description
Incoming ISDN Number	<p>Only for Mode = <i>Passive</i> or <i>Both</i>.</p> <p>Enter the ISDN number from which the remote device calls the local device (calling party number). Wildcards may also be used.</p>
Outgoing ISDN Number	<p>Only for Mode = <i>Active</i> or <i>Both</i>.</p> <p>Enter the ISDN number with which the local device calls the remote device calls (called party number). Wildcards may also be used.</p>
Transfer Own IP Address over ISDN	<p>Select whether the IP address of your own device is to be transferred over ISDN for IPsec callback.</p> <p>The function is activated with <i>Enabled</i>.</p> <p>The function is disabled by default.</p>
Transfer Mode	<p>Only if Transfer Own IP Address over ISDN = Enabled</p> <p>Select the mode in which your device is to attempt to transfer its IP address to the peer.</p> <p>Possible values:</p> <ul style="list-style-type: none"> • <i>Autodetect Best Mode</i> : Your device automatically determines the most favourable mode. It first tries all D channel modes before switching to the B channel. (Costs are incurred for using the B channel.) • <i>Autodetect only D Channel Modes</i> : Your device automatically determines the most favourable D channel mode. The use of the B channel is excluded. • <i>Use specific D Channel Mode</i> : Your device tries to transfer the IP address in the mode set in the D Channel Mode field. • <i>Try specific D Channel Mode, fall back to B Channel</i> : Your device tries to transfer the IP address in the mode set in the D Channel Mode field. If this does not succeed, the IP address is transferred in the B channel. (This incurs costs.) • <i>Use only B Channel Mode</i> : Your device transfers the IP address in the B channel. This incurs costs.

Field	Description
D Channel Mode	<p>Only if Transfer Mode = <i>Use specific D Channel Mode</i> or <i>Try specific D Channel Mode, Fallback to B Channel</i></p> <p>Select the D channel mode in which your device tries to transfer the IP address.</p> <p>Possible values:</p> <ul style="list-style-type: none"> • <i>LLC</i> (default value): The IP address is transferred in the "LLC information elements" of the D channel. • <i>SUBADDR</i> : The IP address is transferred in the subaddress "information elements" of the D channel. • <i>LLC and SUBADDR</i> : The IP address is transferred in both the "LLC" and "subaddress information elements".

11.1.2 Phase-1 Profiles

In the **VPN -> IPSec -> Phase-1 Profiles** menu a list of all configured IPSec phase-1 profiles is shown.

The screenshot shows the web interface for a bintec R1200 device. The top navigation bar includes 'Language English', 'Online Help', 'Logout', and the 'funkwerk' logo. The left sidebar contains a menu with categories like System Management, Physical Interfaces, LAN, Wireless LAN, Routing, WAN, VPN, Firewall, VoIP, Local Services, Maintenance, External Reporting, and Monitoring. The 'VPN' category is expanded, showing sub-items: IPSec, L2TP, PPTP, GRE, and Certificates. The 'IPSec' sub-item is selected, and the 'Phase-1 Profiles' tab is active. The main content area displays a table with the following columns: Default, Description, Proposals, Authentication, Mode, DH Group, and Lifetime. The 'Default' column has a checkbox. Below the table are 'New', 'OK', and 'Cancel' buttons. The table shows one profile with the 'Default' checkbox checked.

Fig. 130: VPN -> IPSec -> Phase-1 Profiles

In the **Standard** column, you can mark the profile to be used as the default profile.

11.1.2.1 New

Choose the **New** button to set up new profiles.

The screenshot shows the configuration interface for a bintec R1200 device. The left sidebar contains a navigation menu with options like System Management, Physical Interfaces, LAN, Wireless LAN, Routing, WAN, VPN, IPsec, L2TP, PPTP, GRE, Certificates, Firewall, VoIP, Local Services, Maintenance, External Reporting, and Monitoring. The main area is titled 'Phase-1 Profiles' and contains a 'New' button. Below this, the 'Phase-1 (IKE) Parameters' section is visible, with the following fields:

- Description: PSK Multiproposal
- Proposals: A table with columns for Encryption, Authentication, and Enabled. The first row shows AES, MD5, and a checked box. The second row shows AES, MD5, and a checked box. The third row shows AES, MD5, and an unchecked box.
- DH Group: Radio buttons for 1(768 Bit), 2(1024 Bit) (selected), and 5(1536 Bit).
- Lifetime: 14400 Seconds, 0 kBytes
- Authentication Method: Preshared Keys
- Mode: Radio buttons for Main Mode (ID Protect), Aggressive (selected), and Strict.
- Local ID Type: Fully Qualified Domain Name (FQDN)
- Local ID Value: r1200

Below the main parameters is the 'Advanced Settings' section:

- Alive Check: Autodetect
- Block Time: 30 Seconds
- NAT Traversal: Enabled

At the bottom of the configuration area are 'OK' and 'Cancel' buttons.

Fig. 131: VPN -> IPsec ->Phase-1 Profiles -> New

The VPN -> IPsec -> Phase-1 Profile-> New menu consists of the following fields:

Fields in the Phase-1 Profile Phase-1 (IKE) Parameters menu

Field	Description
Description	Enter a description that uniquely defines the type of rule.
Proposals	In this field, you can select any combination of encryption and message hash algorithms for IKE phase 1 on your device. The combination of six encryption algorithms and four message hash algorithms gives 24 possible values in this field. At least one proposal must exist. Therefore the first line of the table cannot be deactivated. Encryption algorithms (Encryption):

Field	Description
	<ul style="list-style-type: none"> • <i>3DES</i> (default value): 3DES is an extension of the DES algorithm with an effective key length of 112 bits, which is rated as secure. It is the slowest algorithm currently supported. • <i>Twofish</i>: Twofish was a final candidate for the AES (Advanced Encryption Standard). It is rated as just as secure as Rijndael (AES), but is slower. • <i>Blowfish</i>: Blowfish is a very secure and fast algorithm. Twofish can be regarded as the successor to Blowfish. • <i>CAST</i>: CAST is also a very secure algorithm, marginally slower than Blowfish, but faster than 3DES. • <i>DES</i>: DES is an older encryption algorithm, which is rated as weak due to its small effective length of 56 bits. • <i>AES</i>: Rijndael has been nominated as AES due to its fast key setup, low memory requirements, high level of security against attacks and general speed. • <i>AES-128</i>: Rijndael has been nominated as AES due to its fast key setup, low memory requirements, high level of security against attacks and general speed. Here, it is used with a key length of 128 bits. • <i>AES-192</i>: Rijndael has been nominated as AES due to its fast key setup, low memory requirements, high level of security against attacks and general speed. Here, it is used with a key length of 192 bits. • <i>AES-256</i>: Rijndael has been nominated as AES due to its fast key setup, low memory requirements, high level of security against attacks and general speed. Here, it is used with a key length of 256 bits. <p>Hash algorithms (Authentication):</p> <ul style="list-style-type: none"> • <i>MD5</i> (default value): MD 5 (Message Digest #5) is an older hash algorithm. It is used with a 96 bit digest length for IPsec. • <i>SHA1</i> : SHA1 (Secure Hash Algorithm #1) is a hash algorithm developed by the NSA (United States National Security Association). It is rated as secure, but is slower than MD5. It is used with a 96 bit digest length for IPsec. • <i>RipeMD 160</i>: RipeMD 160 is a 160 bit hash algorithm. It is used as a secure replacement for MD5 and RipeMD. • <i>Tiger192</i>: Tiger 192 is a relatively new and very fast algorithm.

Field	Description
	<p>Please note that the description of the encryption and authentication or the hash algorithms is based on the author's knowledge and opinion at the time of creating this User Guide. In particular, the quality of the algorithms is subject to relative aspects and may change due to mathematical or cryptographic developments.</p>
DH Group	<p>The Diffie-Hellman group defines the parameter set used as the basis for the key calculation during phase 1. "MODP" as supported by bintec devices stands for "modular exponentiation".</p> <p>Possible values:</p> <ul style="list-style-type: none"> • <i>1 (768-bit)</i>: During the Diffie-Hellman key calculation, modular exponentiation at 768 bits is used to create the encryption material. • <i>2 (1024-bit)</i>: During the Diffie-Hellman key calculation, modular exponentiation at 1024 bits is used to create the encryption material. • <i>5 (1536-bit)</i>: During the Diffie-Hellman key calculation, modular exponentiation at 1536 bits is used to create the encryption material.
Lifetime	<p>Create a lifetime for phase 1 keys.</p> <p>As for RFC 2407, the default value is eight hours, which means the key must be renewed once eight hours have elapsed.</p> <p>The following options are available for defining the lifetime:</p> <p>Entry in Seconds: Enter the lifetime for phase 1 key in seconds. The value can be a whole number from 0 to 2147483647. The default value is <i>14400</i>.</p> <p>Entry in kBytes: Enter the lifetime for phase 1 keys as amount of data processed in kBytes. The value can be a whole number from 0 to 2147483647. The default value is <i>0</i>.</p> <p>The standard value as per RFC is used <i>0</i> seconds and <i>0</i> Kbytes are entered.</p>
Authentication Method	<p>Select the authentication method.</p> <p>Possible values:</p>

Field	Description
	<ul style="list-style-type: none"> • <i>Preshared Keys</i> (default value): If you do not use certificates for the authentication, you can select Preshared Keys. These are configured during peer configuration in the IPSec Peers menu. The preshared key is the shared password. • <i>DSA Signature</i>: Phase 1 key calculations are authenticated using the DSA algorithm. • <i>RSA Signature</i>: Phase 1 key calculations are authenticated using the RSA algorithm. • <i>RSA Encryption</i>: In RSA encryption the ID payload is also encrypted for additional security.
Local Certificate	<p>Only if Authentication Method = <i>DSA Signature</i>, <i>RSA Signature</i> or <i>RSA Encryption</i></p> <p>This field enables you to select one of your own certificates for authentication. It shows the index number of this certificate and the name under which it is saved. This field is only shown for authentication settings based on certificates and indicates that a certificate is essential.</p>
Mode	<p>Select the phase 1 mode.</p> <p>Possible values:</p> <ul style="list-style-type: none"> • <i>Aggressive</i> (default value): The Aggressive Mode is necessary if one of the peers does not have a static IP address and preshared keys are used for authentication; it requires only three messages for configuring a secure channel. • <i>Main Mode (ID Protect)</i> : This mode (also designated Main Mode) requires six messages for a Diffie-Hellman key calculation and thus for configuring a secure channel, over which the IPSec SAs can be negotiated. A condition is that both peers have static IP addresses if preshared keys are used for authentication. <p>Also define whether the selected mode is used exclusively (Strict), or the peer can also propose another mode.</p>
Local ID Type	<p>Select the local ID type.</p> <p>Possible values:</p> <ul style="list-style-type: none"> • <i>Fully Qualified Domain Name (FQDN)</i>

Field	Description
	<ul style="list-style-type: none"> • <i>E-mail address</i> • <i>IPV4 Address</i> • <i>ASN.1 DN (Distinguished Name)</i>
Local ID Value	<p>Enter the ID of your device.</p> <p>For Authentication Method = <i>DSA Signature, RSA Signature</i> or <i>RSA Encryption</i>, the Use Subject Name from certificate option is shown.</p> <p>If you enable the Use Subject Name from certificate option, the first alternative subject name indicated in the certificate is used, or, if none is specified, the subject name of the certificate is used.</p> <p>Note: If you use certificates for authentication and your certificate contains alternative subject names (see Certificates on page 359), you must make sure your device selects the first alternative subject name by default. Make sure you and your peer both use the same name, i.e. that your local ID and the peer ID your partner configures for you are identical.</p>

Alive Check

During communication between two IPSec peers, one of the peers may become unavailable, e.g. due to routing problems or a reboot. However, this can only be detected when the end of the lifetime of the security connection is reached. Up until this point the data packets are lost. These are various methods of performing an alive check to prevent this happening. In the **Alive Check** field you can specify whether a method should be used to check the availability of a peer.

Two methods are available: Heartbeats and Dead Peer Detection.

The **Advanced Settings** menu consists of the following fields:

Fields in the Advanced Settings menu

Field	Description
Alive Check	<p>Select the method to be used to check the functionality of the IPSec connection.</p> <p>In addition to the default method Dead Peer Detection (DPD), the (proprietary) Heartbeat method is implemented. This sends and receives signals every 5 seconds, depending on the config-</p>

Field	Description
	<p>uration. If these signals are not received after 20 seconds, the SA is discarded as invalid.</p> <p>Possible values:</p> <ul style="list-style-type: none"> • <i>Autodetect</i> (default value): Your device detects and uses the mode supported by the remote terminal. • <i>Down</i>: Your device sends and expects no heartbeat. Set this option if you use devices from other manufacturers. • <i>Heartbeats (Expect only)</i>: Your device expects a heartbeat from the peer but does not send one itself. • <i>Heartbeats (Send only)</i>: Your device expects no heartbeat from the peer, but sends one itself. • <i>Heartbeats (send & expect)</i>: Your device expects a heartbeat from the peer and sends one itself. • <i>Dead Peer Detection</i>: Use DPD (dead peer detection) in accordance with RFC 3706. DPD uses a request-reply protocol to check the availability of the remote terminal and can be configured independently on both sides. This option only checks the availability of the peer if data is to be sent to it. • <i>Dead Peer Detection (Idle)</i>: Use DPD (dead peer detection) in accordance with RFC 3706. DPD uses a request-reply protocol to check the availability of the remote terminal and can be configured independently on both sides. This option is used to carry out a check at certain intervals depending on forthcoming data transfers.
Block Time	<p>Define how long a peer is blocked for tunnel setups after a phase 1 tunnel setup has failed. This only affects locally initiated setup attempts.</p> <p>Possible values are <i>-1</i> to <i>86400</i> (seconds); <i>-1</i> means the value in the default profile is used and <i>0</i> means that the peer is never blocked.</p> <p>The default value is <i>30</i>.</p>
NAT Traversal	<p>NAT Traversal (NAT-T) also enables IPSec tunnels to be opened via one or more devices on which network address translation (NAT) is activated.</p> <p>Without NAT-T, incompatibilities may arise between IPSec and</p>

Field	Description
	<p>NAT (see RFC 3715, section 2). These primarily prevent the setup of an IPSec tunnel from a host within a LANs and behind a NAT device to another host or device. NAT-T enables these kinds of tunnels without conflicts with NAT device, activated NAT is automatically detected by the IPSec Daemon and NAT-T is used.</p> <p>The function is activated with <i>Enabled</i>.</p> <p>The function is enabled by default.</p>
CA Certificates	<p>Only if Authentication Method = <i>DSA Signature, RSA Signature</i> or <i>RSA Encryption</i></p> <p>If you enable the Trust following CA certificates option, you can select up to three additional CA certificates that are accepted for this profile.</p> <p>This option can only be configured if certificates are loaded.</p>

11.1.3 Phase-2 Profiles

You can define profiles for phase 2 of the tunnel setup just as for phase 1.

In the **VPN -> IPSec -> Phase-2 Profiles** menu a list of all configured IPSec phase-2 profiles is shown.

The screenshot shows the bintec R1200 web interface. On the left is a navigation menu with categories like System Management, Physical Interfaces, LAN, Wireless LAN, Routing, WAN, VPN, Firewall, VoIP, Local Services, Maintenance, External Reporting, and Monitoring. The VPN menu is expanded, showing options like IPsec, L2TP, PPTP, GRE, and Certificates. The main content area is titled 'IPSec Peers Phase-1 Profiles Phase-2 Profiles IP Pools Options'. The 'Phase-2 Profiles' tab is active, displaying a table with columns: Default, Description, Proposals, PFS Group, and Lifetime. The table contains one row with 'Default' in the Default column. Below the table are 'New', 'OK', and 'Cancel' buttons.

Fig. 132: VPN -> IPsec -> Phase-2 Profiles

In the **Standard** column, you can mark the profile to be used as the default profile.

11.1.3.1 New

Choose the **New** button to set up new profiles.

The screenshot shows the configuration page for a new Phase-2 Profile. The navigation menu is the same as in Fig. 132. The main content area is titled 'IPSec Peers Phase-1 Profiles Phase-2 Profiles IP Pools Options'. The 'Phase-2 Profiles' tab is active, and the 'New' button has been clicked, leading to the configuration form. The form is titled 'Phase-2 (IPSEC) Parameters' and contains the following fields:

- Description: Multi-Proposal
- Proposals: A table with columns for Encryption, Authentication, and Enabled.

Encryption	Authentication	Enabled
AES	MD5	<input checked="" type="checkbox"/>
AES	MD5	<input type="checkbox"/>
AES	MD5	<input type="checkbox"/>
- Use PFS Group: Enabled, 1(768 Bit), 2(1024 Bit), 5(1536 Bit)
- Lifetime: 7200 Seconds, 0 kBytes

Below the main parameters is an 'Advanced Settings' section with the following fields:

- IP Compression: Enabled
- Alive Check: Autodetect
- Propagate PMTU: Enabled

At the bottom of the form are 'OK' and 'Cancel' buttons.

Fig. 133: VPN -> IPsec ->Phase-2 Profiles -> New

The VPN -> IPSec -> Phase-2 Profile-> New menu consists of the following fields:

Fields in the Phase-2 Profile Phase-2 (IPSEC) Parameters menu

Field	Description
Description	<p>Enter a description that uniquely identifies the profile.</p> <p>The maximum length of the entry is 255 characters.</p>
Proposals	<p>In this field, you can select any combination of encryption and message hash algorithms for IKE phase 2 on your default. The combination of six encryption algorithms and two message hash algorithms gives 12 possible values in this field.</p> <p>Encryption algorithms (Encryption):</p> <ul style="list-style-type: none"> • <i>3DES</i> (default value): 3DES is an extension of the DES algorithm with an effective key length of 112 bits, which is rated as secure. It is the slowest algorithm currently supported. • <i>-ALL-</i>: All options can be used. • <i>AES-128</i>: Rijndael has been nominated as AES due to its fast key setup, low memory requirements, high level of security against attacks and general speed. Here, it is used with a key length of 128 bits. • <i>AES-192</i>: Rijndael has been nominated as AES due to its fast key setup, low memory requirements, high level of security against attacks and general speed. Here, it is used with a key length of 192 bits. • <i>AES-256</i>: Rijndael has been nominated as AES due to its fast key setup, low memory requirements, high level of security against attacks and general speed. Here, it is used with a key length of 256 bits. • <i>Twofish</i>: Twofish was a final candidate for the AES (Advanced Encryption Standard). It is rated as just as secure as Rijndael (AES), but is slower. • <i>Blowfish</i>: Blowfish is a very secure and fast algorithm. Twofish can be regarded as the successor to Blowfish. • <i>CAST</i>: CAST is also a very secure algorithm, marginally slower than Blowfish, but faster than 3DES. • <i>DES</i>: DES is an older encryption algorithm, which is rated as weak due to its small effective length of 56 bits.

Field	Description
	<p>Hash algorithms (Authentication):</p> <ul style="list-style-type: none"> • <i>MD 5</i> (default value): MD 5 (Message Digest #5) is an older hash algorithm. It is used with a 96 bit digest length for IPSec. • <i>-ALL-</i>: All options can be used. • <i>SHA 1</i>: SHA1 (Secure Hash Algorithm #1) is a hash algorithm developed by the NSA (United States National Security Association). It is rated as secure, but is slower than MD5. It is used with a 96 bit digest length for IPSec. <p>Note that RipeMD 160 and Tiger 192 are not available for message hashing in phase 2.</p>
Use PFS Group	<p>As PFS (Perfect Forward Secrecy) requires another Diffie-Hellman key calculation to create new encryption material, you must select the exponentiation features. If you enable PFS (Enabled), the options are the same as for the configuration in Phase 1: Group. PFS is used to protect the keys of a renewed phase 2 SA, even if the keys of the phase 1 SA have become known.</p> <p>The field has the following options:</p> <ul style="list-style-type: none"> • <i>1 (768-bit)</i>: During the Diffie-Hellman key calculation, modular exponentiation at 768 bits is used to create the encryption material. • <i>2 (1024 Bit)</i> (default value): During the Diffie-Hellman key calculation, modular exponentiation at 1024 bits is used to create the encryption material. • <i>5 (1536-bit)</i>: During the Diffie-Hellman key calculation, modular exponentiation at 1536 bits is used to create the encryption material.
Lifetime	<p>Define how the lifetime is defined that will expire before phase 2 SAs need to be renewed.</p> <p>The new SAs are negotiated shortly before expiry of the current SAs. As for RFC 2407, the default value is eight hours, which means the key must be renewed once eight hours have elapsed.</p> <p>The following options are available for defining the lifetime:</p>

Field	Description
	<p>Entry in <i>Seconds</i>: Enter the lifetime for phase 2 key in seconds. The value can be a whole number from 0 to 2147483647 . The default value is 28800.</p> <p>Entry in <i>kBytes</i>: Enter the lifetime for phase 2 keys as amount of data processed in Kbytes. The value can be a whole number from 0 to 2147483647 . The default value is 0.</p>

The **Advanced Settings** menu consists of the following fields:

Fields in the Advanced Settings menu

Field	Description
IP Compression	<p>Select whether compression is to be activated before data encryption. If data is compressed effectively, this can result in higher performance and a lower volume of data to be transferred. In the case of fast lines or data that cannot be compressed, you are advised against using this option as the performance can be significantly affected by the increased effort during compression.</p> <p>The function is activated with <i>Enabled</i>.</p> <p>The function is disabled by default.</p>
Alive Check	<p>Select whether and how IPSec heartbeats are used.</p> <p>A bintec IPSec heartbeat is implemented to determine whether or not a Security Association (SA) is still valid. This function sends and receives signals every 5 seconds, depending on the configuration. If these signals are not received after 20 seconds, the SA is discarded as invalid.</p> <p>Possible values:</p> <ul style="list-style-type: none"> • <i>Down</i> : Your device sends and expects no heartbeat. Set this option if you use devices from other manufacturers. • <i>Heartbeats (Expect only)</i>: Your device expects a heartbeat from the peer but does not send one itself. • <i>Heartbeats (Send only)</i>: Your device expects no heartbeat from the peer, but sends one itself. • <i>Heartbeats (send & expect)</i>: Your device expects a heartbeat from the peer and sends one itself.

Field	Description
	<ul style="list-style-type: none"> <i>Autodetect</i>: Automatic detection of whether the remote terminal is a bintec device. If it is, Heartbeat Both (for a remote terminal with bintec) or None (for a remote terminal without bintec) is set.
Propagate PMTU	<p>Select whether the PMTU (Path Maximum Transfer Unit) is to be propagated during phase 2.</p> <p>The function is activated with <i>Enabled</i>.</p> <p>The function is enabled by default.</p>

11.1.4 IP Pools

In the **IP Pools** menu a list of all IP pools for your configured IPsec connections is displayed.

If have set **IP Address Assignment** *IKE Config Mode* for an IPsec peer, you must define the IP pools from which the IP addresses are assigned.

Use the **Add** button to set up new IP pools.

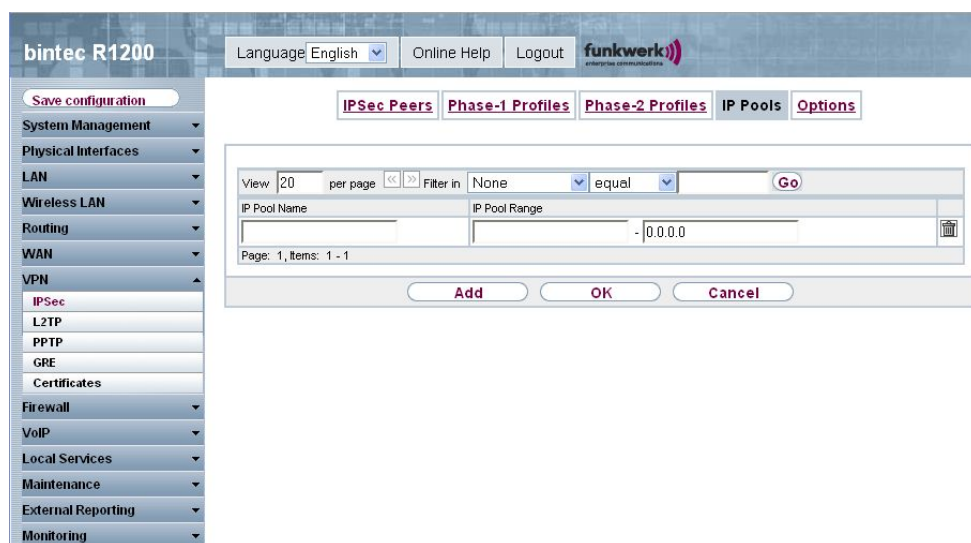

Fig. 134: VPN -> IPsec -> IP Pools -> Add

The **VPN -> IPsec -> IP Pools -> Add** menu consists of the following fields:

Fields in the Options IP Pools menu

Field	Description
IP Pool Name	Enter the name of the IP pool.
IP Pool Range	In the first field, enter the first IP address of the range. In the second field, enter the last IP address of the range.

11.1.5 Options

The screenshot shows the bintec R1200 VPN configuration interface. The left sidebar contains a navigation menu with categories like System Management, Physical Interfaces, LAN, Wireless LAN, Routing, WAN, VPN, IPsec, L2TP, PPTP, GRE, Certificates, Firewall, VoIP, Local Services, Maintenance, External Reporting, and Monitoring. The main content area is titled 'IPsec Peers' and has tabs for 'IPsec Peers', 'Phase-1 Profiles', 'Phase-2 Profiles', 'IP Pools', and 'Options'. The 'Options' tab is active, showing 'Global Options' and 'Advanced Settings' sections. The 'Global Options' section includes 'Enable IPsec' (checkbox), 'Delete complete IPsec configuration' (trash icon), and 'IPsec Debug Level' (dropdown menu). The 'Advanced Settings' section includes 'Send Initial Contact Message' (checkbox), 'Sync SAs with ISP interface state' (checkbox), 'Use Zero Cookies' (checkbox), 'Dynamic RADIUS Authentication' (checkbox), and 'PKI Handling Options' (checkbox) with sub-options for 'Ignore Certificate Request Payloads', 'Send Certificate Request Payloads', 'Send Certificate Chains', 'Send CRLs', and 'Send Key Hash Payloads'. At the bottom are 'OK' and 'Cancel' buttons.

Fig. 135: VPN -> IPsec -> Options

The VPN -> IPsec -> Options menu consists of the following fields:

Fields in the Options Global Options menu

Field	Description
Enable IPsec	Select whether you want to activate IPsec. The function is activated with <i>Enabled</i> . The function is active as soon as an IPsec Peer is configured.
Delete complete IPsec	If you click the  icon, delete the complete IPsec configuration

Field	Description
configuration	<p>of your device.</p> <p>This cancels all settings made during the IPsec configuration. Once the configuration is deleted, you can start with a completely new IPsec configuration.</p> <p>You can only delete the configuration if Enable IPsec = <i>Not activated</i>.</p>
IPsec Debug Level	<p>Select the priority of the syslog messages of the IPsec subsystem to be recorded internally.</p> <p>Possible values:</p> <ul style="list-style-type: none"> • <i>Emergency</i> (highest priority) • <i>Alert</i> • <i>Critical</i> • <i>Error</i> • <i>Warning</i> • <i>Notice</i> • <i>Information</i> • <i>Debug</i> (default value, lowest priority) <p>Syslog messages are only recorded internally if they have a higher or identical priority to that indicated, i.e. all messages generated are recorded at syslog level debug.</p>

The **Advanced Settings** menu is for adapting certain functions and features to the special requirements of your environment, i.e. mostly interoperability flags are set. The default values are globally valid and enable your system to work correctly to other **bintec** devices, so that you only need to change these values if the remote terminal is a third-party product or you know special settings are necessary. These may be needed, for example, if the remote end operates with older IPsec implementations.

The **Advanced Settings** menu consists of the following fields:

Fields in the Advanced Settings menu

Field	Description
Send Initial Contact Message	<p>Select whether IKE Initial Contact messages are to be sent during IKE (phase 1) if no SAs with a peer exist.</p> <p>The function is activated with <i>Enabled</i>.</p>

Field	Description
	The function is enabled by default.
Sync SAs with ISP interface state	<p>Select whether all SAs are to be deleted whose data traffic was routed via an interface on which the status has changed from <i>Up</i> to <i>Down</i>, <i>Dormant</i> or <i>Blocked</i>.</p> <p>The function is activated with <i>Enabled</i>.</p> <p>The function is disabled by default.</p>
Use Zero Cookies	<p>Select whether zeroed ISAKMP Cookies are to be sent.</p> <p>These are equivalent to the SPI (Security Parameter Index) in IKE proposals; as they are redundant, they are normally set to the value of the negotiation currently in progress. Alternatively, your device can use zeroes for all values of the cookie. In this case choose <i>Enabled</i>.</p>
Zero Cookie Size	<p>Only if Use Zero Cookies = activated.</p> <p>Enter the length in bytes of the zeroed SPI used in IKE proposals.</p> <p>The default value is <i>32</i>.</p>
Dynamic RADIUS Authentication	<p>Select whether RADIUS authentication is to be activated via IPsec.</p> <p>The function is activated with <i>Enabled</i>.</p> <p>The function is disabled by default.</p>

Fields in the Advanced Settings PKI Editing Options menu

Field	Description
Ignore Certificate Request Payloads	<p>Select whether certificate requests received from the remote end during IKE (phase 1) are to be ignored.</p> <p>The function is activated with <i>Enabled</i>.</p> <p>The function is disabled by default.</p>
Send Certificate Request Payloads	Select whether certificate requests are to be sent during IKE (phase 1).

Field	Description
	<p>The function is activated with <i>Enabled</i>.</p> <p>The function is enabled by default.</p>
Send Certificate Chains	<p>Select whether complete certificate chains are to be sent during IKE (phase 1).</p> <p>The function is activated with <i>Enabled</i>.</p> <p>The function is enabled by default.</p> <p>Deactivate this function if you do not wish to send the peer the certificates of all levels (from your level to the CA level).</p>
Send CRLs	<p>Select whether CRLs are to be sent during IKE (phase 1).</p> <p>The function is activated with <i>Enabled</i>.</p> <p>The function is disabled by default.</p>
Send Key Hash Payloads	<p>Select whether key hash payloads are to be sent during IKE (phase 1).</p> <p>In the default setting, the public key hash of the remote end is sent together with the other authentication data. Only applies for RSA encryption; activate this function with <i>Enabled</i> to suppress this behaviour.</p>

11.2 L2TP

The layer 2 tunnel protocol (L2TP) enables PPP connections to be tunnelled via a UDP connection.

Your **bintec** device supports the following two modes:

- L2TP LNS Mode (L2TP Network Server): for incoming connections only
- L2TP LAC Mode (L2TP Access Concentrator): for outgoing connections only

Note the following when configuring the server and client: An L2TP tunnel profile must be created on each of the two sides (LAC and LNS). The corresponding L2TP tunnel profile is used on the initiator side (LAC) to set up the connection. The L2TP tunnel profile is needed on the responder side (LNS) to accept the connection.

11.2.1 Tunnel Profiles

In the **VPN -> L2TP -> Tunnel Profiles** menu a list of all configured tunnel profiles is shown.

11.2.1.1 New

Choose the **New** button to set up new tunnel profiles.

The screenshot shows the web interface for configuring a new L2TP tunnel profile. The left sidebar contains a navigation menu with 'VPN' expanded to 'L2TP'. The main content area has tabs for 'Tunnel Profiles', 'Users', and 'Options'. The 'Tunnel Profiles' tab is active, showing a form with two sections: 'Basic Parameters' and 'Advanced Settings'. The 'Basic Parameters' section includes fields for Description (L2TP1), Local Hostname, Remote Hostname, Password (masked with dots), Remote IP Address, UDP Source Port (with a 'Fixed' checkbox), and UDP Destination Port (1701). The 'Advanced Settings' section includes fields for Local IP Address, Hello Interval (30 Seconds), Minimum Time between Retries (1 Seconds), Maximum Time between Retries (16 Seconds), Maximum Retries (5), and Data Packets Sequence Numbers (with an 'Enabled' checkbox). Buttons for 'OK' and 'Cancel' are at the bottom.

Fig. 136: VPN -> L2TP -> Tunnel Profiles -> New

The **VPN -> L2TP -> Tunnel Profiles -> New** menu consists of the following fields:

Fields in the Tunnel Profiles Basic Parameters menu

Field	Description
Description	<p>Enter a description for the current profile.</p> <p>The device automatically names the profiles <i>L2TP</i> and numbers them, but the value can be changed.</p>

Field	Description
Local Hostname	<p>Enter the host name for LNS or LAC.</p> <ul style="list-style-type: none"> • LAC: The Local Hostname is used in outgoing tunnel setup messages to identify this device and is associated with the Remote Hostname of a tunnel profile configured on the LNS. These tunnel setup messages are SCCRQs (Start Control Connection Request) sent from the LAC and SCCRPs (Start Control Connection Reply) sent from the LNS. • LNS: Is the same as the value for Remote Hostname of the incoming tunnel setup message from the LAC.
Remote Hostname	<p>Enter the host name of the LNS or LAC.</p> <ul style="list-style-type: none"> • LAC: Defines the value for Local Hostname of the LNS (contained in the SCCRQs received from the LNS and the SCCRPs received from the LAC). The Local Hostname configured in the LAC must match the Remote Hostname configured for the intended profile in the LNS and vice versa. • LNS: Defines the Local Hostname of the LAC. If the Remote Hostname field remains empty on the LNS, the related profile qualifies as the standard entry and is used for all incoming calls for which a profile with a matching Remote Hostname can be found.
Password	<p>Enter the password to be used for tunnel authentication. Authentication between LAC and LNS takes place in both directions, i.e. the LNS checks the Local Hostname and the Password contained in the SCCRQ of the LAC and compares them with those specified in the relevant profile. The LAC does the same with the fields of the SCCRP of the LNS.</p> <p>If this field remains empty, authentication data in the tunnel setup messages are not sent and are ignored.</p>

Fields in the Tunnel Profiles LAC Mode Parameters menu

Field	Description
Remote IP Address	<p>Enter the fixed IP address of the LNS used as the destination address for connections based on this profile.</p> <p>The destination must be a device that can behave like an LNS.</p>
UDP Source Port	<p>Enter how the port number to be used as the source port for all outgoing L2TP connections based on this profile is to be de-</p>

Field	Description
	<p>terminated.</p> <p>By default, the Fixed option is disabled, which means that ports are dynamically assigned to the connections that use this profile.</p> <p>If you want to enter a fixed port, enable the Fixed option. Select this option if you encounter problems with the firewall or NAT.</p> <p>The available values are 0 to 65535.</p>
UDP Destination Port	<p>Enter the destination port number to be used for all calls based on this profile. The remote LNS that receives the call must monitor this port on L2TP connections.</p> <p>Possible values are 0 ... 65535.</p> <p>The default value is 1701 (RFC 2661).</p>

The **Advanced Settings** menu consists of the following fields:

Fields in the Advanced Settings menu

Field	Description
Local IP Address	<p>Enter the IP address to be used as the source address for all L2TP connections based on this profile.</p> <p>If this field is left empty, your device uses the IP address of the interface used to reach Remote IP Address by the L2TP tunnel.</p>
Hello Interval	<p>Enter the interval (in seconds) between the sending of two L2TP HELLO messages. These messages are used to keep the tunnel open.</p> <p>The available values are 0 to 255, the default value is 30. The value 0 means that no L2TP HELLO messages are sent.</p>
Minimum Time between Retries	<p>Enter the minimum time (in seconds) that your device waits before resending a L2TP control packet for which it received no response.</p> <p>The wait time is dynamically extended until it reaches the Maximum Time between Retries. The available values are 1 to</p>

Field	Description
	255, the default value is 1.
Maximum Time between Retries	<p>Enter the maximum time (in seconds) that your device waits before resending a L2TP control packet for which it received no response.</p> <p>The available values are 8 to 255, the default value is 16.</p>
Maximum Retries	<p>Enter the maximum number of times your device is to try to resend the L2TP control packet for which is received no response.</p> <p>The available values are 8 to 255, the default value is 5.</p>
Data Packets Sequence Numbers	<p>Select whether your device is to use sequence numbers for data packets sent through a tunnel on the basis of this profile.</p> <p>The function is not currently used.</p> <p>The function is activated with <i>Enabled</i>.</p> <p>The function is disabled by default.</p>

11.2.2 User

In the **VPN** -> **L2TP** -> **Users** menu a list of all configured L2TP partners is shown.

11.2.2.1 New

Choose the **New** button to set up new L2TP partners.

bintec R1200 Language English Online Help Logout **funkwerk**

Save configuration Tunnel Profiles Users Options

System Management
Physical Interfaces
 LAN
 Wireless LAN
 Routing
 WAN
 VPN
 IPsec
 L2TP
 PPTP
 GRE
 Certificates
 Firewall
 VoIP
 Local Services
 Maintenance
 External Reporting
 Monitoring

Basic Parameters

Description

Connection Type LNS LAC

User Name

Password

Always on Enabled

Connection Idle Timeout 300 Seconds

IP Mode and Routes

IP Address Mode Static Provide IP Address

Default Route Enabled

Create NAT Policy Enabled

Local IP Address

Route Entries

Remote IP Address	Netmask	Metric
		1

Add

Advanced Settings

Block after connection failure for 300 Seconds

Authentication PAP/CHAP/MS-CHAP

Encryption None Enabled Windows compatible

LCP Alive Check Enabled

Prioritize TCP ACK Packets Enabled

IP Options

OSPF Mode Passive Active Inactive

Proxy ARP Mode Inactive Up or Dormant Up only

DNS Negotiation Enabled

OK Cancel

Fig. 137: VPN -> L2TP -> Users-> New

The VPN -> L2TP -> Users-> New menu consists of the following fields:

Fields in the Users Basic Parameters menu

Field	Description
Description	Enter a name for uniquely identifying the L2TP partner. The first character in this field must not be a number and no special characters or umlauts must be used either. The maximum length of the entry is 25 characters.
Connection Type	Select whether the L2TP partner is to take on the role of the

Field	Description
	<p>L2TP network server (LNS) or the functions of a L2TP access concentrator client (LAC client).</p> <p>Possible values:</p> <ul style="list-style-type: none"> • <i>LNS</i> (default value): If you select this option, the L2TP partner is configured so that it accepts L2TP tunnels and restores the encapsulated PPP traffic flow. • <i>LAC</i> : If you select this option, the L2TP partner is configured so that it encapsulates a PPP traffic flow in L2TP and sets up a L2TP tunnel to a remote LNS.
Tunnel Profile	<p>Only for Connection Type = <i>LAC</i></p> <p>Select a profile created in the Tunnel Profiles menu for the connection to this L2TP partner.</p>
User Name	Enter the code of your device.
Password	Enter the password.
Always on	<p>Select whether the interface should always be activated.</p> <p>The function is activated with <i>Enabled</i>.</p> <p>The function is disabled by default.</p>
Connection Idle Timeout	<p>Only if Always on is disabled.</p> <p>Enter the idle time in seconds for static short hold. The static short hold setting determines how many seconds should pass between sending the last traffic data packet and clearing the connection.</p> <p>Possible values are 0 to 3600 (seconds). 0 deactivates the short hold. The default value is 300.</p>

Fields in the Users IP Mode and Routes menu

Field	Description
IP Address Mode	<p>Select whether your device is to be assigned a static IP address or whether it should be assigned this dynamically.</p> <p>Possible values:</p>

Field	Description
	<ul style="list-style-type: none"> • <i>Static</i> (default value): You enter a static IP address. • <i>Provide IP Address</i>: Only for Connection Type = <i>LNS</i>. Your device dynamically assigns an IP address to the remote terminal. • <i>Get IP Address</i>: Only for Connection Type = <i>LAC</i>. Your device is dynamically assigned an IP address.
Default Route	<p>Only if IP Address Mode = <i>Get IP Address</i> and <i>Static</i></p> <p>Select whether the route to this connection partner is to be defined as the default route.</p> <p>The function is activated with <i>Enabled</i>.</p> <p>The function is disabled by default.</p>
Create NAT Policy	<p>Only if IP Address Mode = <i>Get IP Address</i> and <i>Static</i></p> <p>Specify whether Network Address Translation (NAT) is to be activated for this connection.</p> <p>The function is activated with <i>Enabled</i>.</p> <p>The function is disabled by default.</p>
IP Assignment Pool (IPCP)	<p>Only if IP Address Mode = <i>Provide IP Address</i></p> <p>Select an IP pool configured in the WAN -> Internet + Dialup -> IP Pools menu.</p>
Local IP Address	<p>Only for IP Address Mode = <i>Static</i></p> <p>Enter the WAN IP address of your device.</p>
Route Entries	<p>Only for IP Address Mode = <i>Static</i></p> <p>Enter the Remote IP Address and Netmask of the L2TP partner LAN and the corresponding Metric. Add new entries with Add.</p>

The **Advanced Settings** menu consists of the following fields:

Fields in the Advanced Settings menu

Field	Description
Block after connection failure for	Enter the wait time in seconds before the device should try again after an attempt to set up a connection has failed. The default value is <i>300</i> .
Authentication	<p>Select the authentication protocol for this L2TP partner.</p> <p>Possible values:</p> <ul style="list-style-type: none"> • <i>PAP/CHAP/MS-CHAP</i> (default value): Primarily run CHAP, on denial, the authentication protocol required by the PPTP partner. (MSCHAP version 1 or 2 possible.) • <i>PAP</i>: Only run <i>PAP</i> (PPP Password Authentication Protocol); the password is transferred unencrypted. • <i>CHAP</i>: Only run <i>CHAP</i> (PPP Challenge Handshake Authentication Protocol as per RFC 1994); the password is transferred encrypted. • <i>PAP/CHAP</i>: Primarily run CHAP, otherwise PAP. • <i>MS-CHAPv1</i>: Only run MS-CHAP version 1 (PPP Microsoft Challenge Handshake Authentication Protocol). • <i>MS-CHAPv2</i>: Run MS-CHAP version 2 only.
Encryption	<p>If necessary, select the type of encryption that should be used for data traffic to the L2TP partner. This is only possible if STAC or MS-STAC compression is not activated for the connection. If Encryption is set, the remote terminal must also support it, otherwise a connection cannot be set up.</p> <p>Possible values:</p> <ul style="list-style-type: none"> • <i>None</i>: MPP encryption is not used. • <i>Enabled</i> (default value): MPP encryption V2 with 128 bit is used to RFC 3078. • <i>Windows compatible</i>: MPP encryption V2 with 128 bit is used as compatible with Microsoft and Cisco.
LCP Alive Check	<p>Check whether the availability of the remote terminal is to be checked by sending LCP echo requests or replies. This is recommended for leased lines, PPTP and L2TP connections.</p> <p>The function is activated with <i>Enabled</i>.</p>

Field	Description
	The function is disabled by default.
Prioritize TCP ACK Packets	Select whether the TCP download is to be optimised in the event of intensive TCP upload. This function can be specially applied for asymmetrical bandwidths (ADSL). The function is activated with <i>Enabled</i> . The function is disabled by default.

Fields in the Advanced Settings IP Options menu

Field	Description
OSPF Mode	Select whether and how routes are propagated via the interface and/or OSPF protocol packets are to be sent. Possible values: <ul style="list-style-type: none"> • <i>Passive</i> (default value) OSPF is not activated for this interface, i.e. no routes are propagated or OSPF protocol packets sent over this interface. Networks reachable over this interface are, however, included when calculating the routing information and propagated over active interfaces. • <i>Active</i>: OSPF is activated for this interface, i.e. routes are propagated or OSPF protocol packets sent over this interface. • <i>Down</i> : OSPF is disabled for this interface.
Proxy ARP Mode	Select whether your device is to respond to ARP requests from its own LAN on behalf of the specific L2TP partner. Possible values: <ul style="list-style-type: none"> • <i>Inactive</i> (default value): Deactivates Proxy ARP for this L2TP partner. • <i>Up or Dormant</i>: Your device only responds to an ARP request if the status of the connection to the L2TP partner is <i>Up</i> (active) or <i>Dormant</i>. In the case of <i>Idle</i>, your device only responds to the ARP request; the connection is not set up until someone actually wants to use the route. • <i>Active Only</i>: Your device responds to an ARP request only if the status of the connection to the L2TP partner is <i>Up</i> (active), i.e. a connection already exists to the L2TP partner.

Field	Description
DNS Negotiation	<p>Select whether your device receives IP addresses for primary DNS server, secondary DNS server, primary WINS and secondary WINS from the L2TP partner or sends these to the L2TP partner.</p> <p>The function is activated with <i>Enabled</i>.</p> <p>The function is enabled by default.</p>

11.2.3 Options

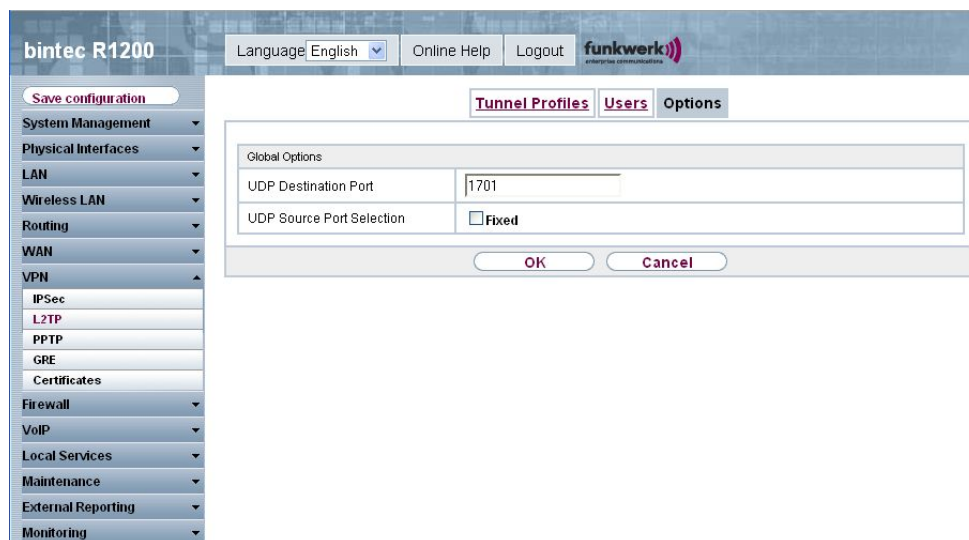

Fig. 138: VPN -> L2TP ->Options

The **VPN -> L2TP -> Options** menu consists of the following fields:

Fields in the Options Global Options menu

Field	Description
UDP Destination Port	<p>Enter the port to be monitored by the LNS on incoming L2TP tunnel connections.</p> <p>Available values are all whole numbers from 1 to 65535, the default value is 1701, as specified in RFC 2661.</p>
UDP Source Port Selec-	Select whether the LNS should only use the monitored port

Field	Description
tion	<p>UDP destination port) as the local source port for the L2TP connection.</p> <p>The function is activated with <i>Fixed</i>.</p> <p>The function is disabled by default.</p>

11.3 PPTP

The Point-to-Point Tunneling Protocol (=PPTP) can be used to set up an encrypted PPTP tunnel to provide security for data traffic over an existing IP connection.

First a connection to an ISP (=Internet Service Provider) is set up at both sites. Once these connections are available, a tunnel is set up to the PPTP partner over the Internet using PPTP.

The PPTP subsystem sets up a control connection between the endpoints of the tunnel. This is used to send control data to set up, keep alive and terminate the connection between the two PPTP tunnel end-points. As soon as this control connection is set up, the PPTP transfers the traffic data packed in GRE packets (GRE = Generic Routing Encapsulation).

11.3.1 PPTP Tunnel

In the **PPTP Tunnel** menu, a list of all PPTP tunnels is shown.

11.3.1.1 New

Click on **New** to set up further PPTP partners.

The screenshot shows the configuration interface for a PPTP Tunnel on a bintec R1200 device. The interface is divided into a left sidebar menu and a main configuration area.

Left Sidebar Menu:

- Save configuration
- System Management
- Physical Interfaces
- LAN
- Wireless LAN
- Routing
- WAN
- VPN
 - IPSec
 - L2TP
 - PPTP**
 - GRE
 - Certificates
- Firewall
- VoIP
- Local Services
- Maintenance
- External Reporting
- Monitoring

Main Configuration Area:

Language: English | Online Help | Logout | **funkwerk** enterprise communications

PPTP Tunnels | **Options**

PPTP Partner Parameters

Description	<input type="text"/>
PPTP Mode	<input checked="" type="radio"/> PNS <input type="radio"/> Windows Client Mode
User Name	<input type="text"/>
Password	••••••••
Always on	<input type="checkbox"/> Enabled
Connection Idle Timeout	300 Seconds
Remote PPTP IP Address	<input type="text"/>

IP Mode and Routes

IP Address Mode	<input checked="" type="radio"/> Static <input type="radio"/> Provide IP Address
Default Route	<input type="checkbox"/> Enabled
Create NAT Policy	<input type="checkbox"/> Enabled
Local IP Address	<input type="text"/>

Route Entries

Remote IP Address	Netmask	Metric
<input type="text"/>	<input type="text"/>	1

Advanced Settings

Block after connection failure for	300 Seconds
Authentication	MS-CHAPv2
Encryption	<input type="radio"/> None <input checked="" type="radio"/> Enabled <input type="radio"/> Windows compatible
LCP Alive Check	<input checked="" type="checkbox"/> Enabled
IP Options	
OSPF Mode	<input checked="" type="radio"/> Passive <input type="radio"/> Active <input type="radio"/> Inactive
Proxy ARP Mode	<input checked="" type="radio"/> Inactive <input type="radio"/> Up or Dormant <input type="radio"/> Up only
DNS Negotiation	<input checked="" type="checkbox"/> Enabled
PPTP Callback	
Callback	<input type="checkbox"/> Enabled

OK Cancel

Fig. 139: VPN -> PPTP -> PPTP Tunnel -> New

The VPN -> PPTP -> PPTP tunnel -> New menu consists of the following fields:

Fields in the PPTP Tunnel PPTP Partner Parameter menu

Field	Description
Description	Enter a unique name for the tunnel.

Field	Description
	The first character in this field must not be a number and no special characters or umlauts must be used either.
PPTP Mode	Enter the role to be assigned to the PPTP interface. Possible values: <ul style="list-style-type: none"> • <i>PNS</i> (default value): this assigns the PPTP interface the role of PPTP server. • <i>Windows Client Mode</i>: this assigns the PPTP interface the role of PPTP client.
User Name	Enter the user name.
Password	Enter the password.
Always on	Select whether the interface should always be activated. The function is activated with <i>Enabled</i> . The function is disabled by default.
Connection Idle Timeout	Only if Always up is disabled. Enter the idle interval in seconds. This determines how many seconds should pass between sending the last traffic data packet and clearing the connection. Possible values are 0 to 3600 (seconds). 0 deactivates the timeout. The default value is 300. Example: 10 for FTP transmission, 20 for LAN-to-LAN transmission, 90 for Internet connections.
Remote PPTP IP Address	Enter the IP address of the PPTP partner.

Fields in the PPTP Tunnel IP Mode and Routes menu

Field	Description
IP Address Mode	Select whether your device is to be assigned a static IP address or whether it should be assigned this dynamically. Possible values:

Field	Description
	<ul style="list-style-type: none"> • <i>Static</i> (default value): You enter a static IP address. • <i>Provide IP Address</i>: Your device dynamically assigns an IP address to the remote terminal.
Default Route	<p>Only if IP Address Mode = <i>Static</i></p> <p>Select whether the route to this connection partner is to be defined as the default route.</p> <p>The function is activated with <i>Enabled</i>.</p> <p>The function is disabled by default.</p>
Create NAT Policy	<p>Only if IP Address Mode = <i>Static</i></p> <p>When you configure an ISDN connection, specify whether Network Address Translation (NAT) is to be enabled.</p> <p>The function is activated with <i>Enabled</i>.</p> <p>The function is disabled by default.</p>
Local IP Address	<p>Only for IP Address Mode = <i>Static</i></p> <p>Assign the IP address from your LAN to the ISDN interface which is to be used as your device's internal source address.</p>
Route Entries	<p>Only if IP Address Mode = <i>Static</i></p> <p>Define routing entries for this connection partner.</p> <ul style="list-style-type: none"> • <i>Remote IP Address</i>: IP address of the destination host or LAN. • <i>Netmask</i>: Netmask of Remote IP Address. • <i>Metric</i>: The lower the value, the higher the priority of the route (possible values 0 . . . 15). The default value is 1.
IP Assignment Pool (IPCP)	<p>Only if IP Address Mode = <i>Provide IP Address</i></p> <p>Select an IP pool configured in the WAN -> Internet + Dialup -> IP Pools menu. If an IP pool has not been configured here yet, the message <i>Not yet defined</i> appears in this field.</p>

The **Advanced Settings** menu consists of the following fields:

Fields in the Advanced Settings menu

Field	Description
Block after Connection Failure for	<p>Enter the wait time in seconds before the device should try again after an attempt to set up a connection has failed.</p> <p>The default value is <i>300</i>.</p>
Authentication	<p>Select the authentication protocol for this PPTP partner.</p> <p>Possible values:</p> <ul style="list-style-type: none"> • <i>PAP</i>: Only run <i>PAP</i> (PPP Password Authentication Protocol); the password is transferred unencrypted. • <i>CHAP</i>: Only run <i>CHAP</i> (PPP Challenge Handshake Authentication Protocol as per RFC 1994); the password is transferred encrypted. • <i>PAP/CHAP</i>: Primarily run CHAP, otherwise PAP. • <i>MS-CHAPv1</i>: Only run MS-CHAP version 1 (PPP Microsoft Challenge Handshake Authentication Protocol). • <i>PAP/CHAP/MS-CHAP</i> : Give priority to CHAP, if refused use the authentication protocol requested by the PPTP partner. (MSCHAP version 1 or 2 possible.) • <i>MS-CHAPv2</i>(default value): Run MS-CHAP version 2 only.
Encryption	<p>If necessary, select the type of encryption that should be used for data traffic to the connection partner. If Encryption is set, the remote terminal must also support it, otherwise a connection cannot be set up.</p> <p>Possible values:</p> <ul style="list-style-type: none"> • <i>None</i>: MPP encryption is not used. • <i>Enabled</i> (default value): MPP encryption V2 with 128 bit is used to RFC 3078. • <i>Windows compatible</i>: MPP encryption V2 with 128 bit is used as compatible with Microsoft and Cisco.
LCP Alive Check	<p>Check whether the availability of the remote terminal is to be checked by sending LCP echo requests or replies. This is recommended for leased lines, PPTP and L2TP connections.</p> <p>The function is activated with <i>Enabled</i>.</p>

Field	Description
	The function is enabled by default.

Fields in the Advanced Settings IP Options menu

Field	Description
OSPF Mode	<p>Select whether and how routes are propagated via the interface and/or OSPF protocol packets are to be sent.</p> <p>Possible values:</p> <ul style="list-style-type: none"> • <i>Passive</i> (default value) OSPF is not activated for this interface, i.e. no routes are propagated or OSPF protocol packets sent over this interface. Networks reachable over this interface are, however, included when calculating the routing information and propagated over active interfaces. • <i>Active</i>: OSPF is activated for this interface, i.e. routes are propagated or OSPF protocol packets sent over this interface. • <i>Down</i> : OSPF is disabled for this interface.
Proxy ARP Mode	<p>Select whether your device is to answer APR requests from your LAN on behalf of the specific PPTP partner.</p> <p>Possible values:</p> <ul style="list-style-type: none"> • <i>Inactive</i> (default value): Disables Proxy-ARP (Address Resolution Protocol) for this PPTP partner. • <i>Up or Dormant</i>: Your device answers an APR request only if the status of the connection to the PPTP partner is <i>Active</i> or <i>Idle</i>. In the case of <i>Idle</i>, your device only responds to the ARP request; the connection is not set up until someone actually wants to use the route. • <i>Active Only</i>: Your device answers an APR request only if the status of the connection to the PPTP partner is <i>Active</i>, i.e. if a connection to the PPTP partner has already been established.
DNS Negotiation	<p>Select whether your device should obtain IP addresses for Primary DNS client, Secondary DNS client from the PPTP partner or should send these to the PPTP partner.</p> <p>The function is activated with <i>Enabled</i>.</p> <p>The function is enabled by default.</p>

Fields in the Advanced Settings PPTP Callback menu

Field	Description
Callback	<p>Enables a PPTP tunnel through the Internet to be set up with a PPTP partner, even if the partner is currently inaccessible. As a rule, the PPTP partner will be requested by means of an ISDN call to go online and set up a PPTP connection.</p> <p>The function is activated with <i>Enabled</i>.</p> <p>The function is disabled by default.</p> <p>Note that you must activate the relevant option on the gateways of both partners. An ISDN connection is usually required for this function. Without ISDN, callback is only to be activated in special applications.</p>
Incoming ISDN Number	<p>Only if Callback is enabled.</p> <p>Enter the ISDN number from which the remote device calls the local device (calling party number).</p>
Outgoing ISDN Number	<p>Only if Callback is enabled.</p> <p>Enter the ISDN number with which the local device calls the remote device (called party number).</p>

Fields in the Advanced Settings Dial Port Selection (only if callback = enabled) menu

Field	Description
Selected Ports	<p>Enter the ISDN port over which callback is carried out.</p> <p>Possible values:</p> <ul style="list-style-type: none"> • <i>All Ports</i>: The callback is routed over an available ISDN port. • <i>Specify Port</i>: You can select the required ISDN port under Specific Ports.
Specific Ports	<p>Only if Selected Ports = <i>Specify port</i> can you use Add to select further ports.</p>

11.3.2 Options

In this menu, you can make general settings of the global PPTP profile.

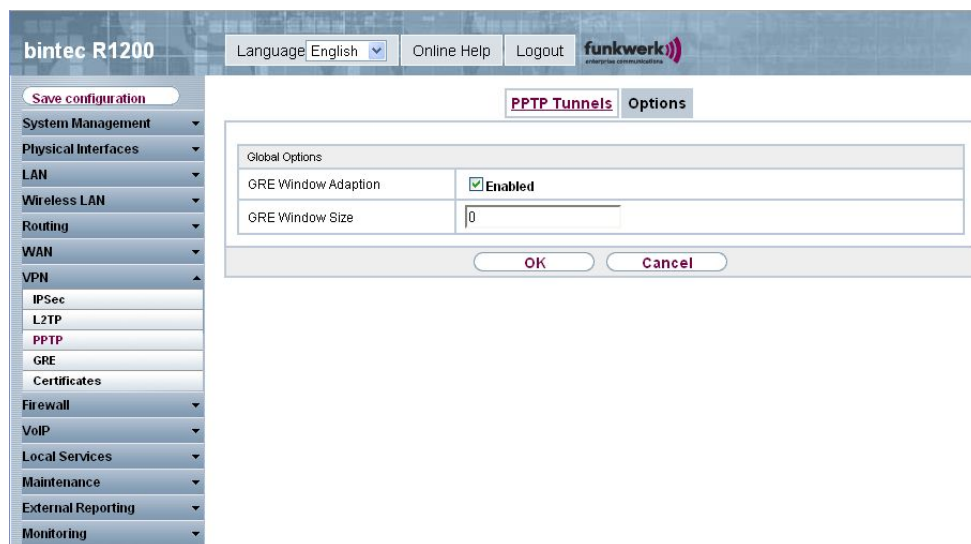

Fig. 140: VPN -> PPTP -> Options

The menu, **VPN -> PPTP -> Options** consists of the following fields:

Fields in the Options Global Options menu

Field	Description
GRE Window Adaption	<p>Select whether the GRE Window Adaption is to be enabled.</p> <p>This adaptation only becomes necessary if you have downloaded service pack 1 from the Microsoft Windows XP page and installed it. Since, in SP 1, Microsoft has changed the confirmation algorithm in the GRE protocol, the automatic window adaptation for GRE must be turned off on the funkwerk side.</p> <p>The function is activated with <i>Enabled</i>.</p> <p>The function is enabled by default.</p>
GRE Window Size	<p>Enter the maximum number of GRE packets that can be sent without confirmation.</p> <p>Windows XP uses a higher initial reception window in the GRE, which is why the maximum send window size on the funkwerk</p>

Field	Description
	side must be adjusted here via the value, GRE Window Size . Possible values are 0 to 256.

11.4 GRE

Generic Routing Encapsulation (GRE) is a network protocol that encapsulates other protocols and transports them in the form of IP tunnels to the specified recipients.

The specification of the GRE protocol is available in two versions:

- GRE V.1 for use in PPTP connections (RFC 2637, configuration in the **PPTP** menu)
- GRE V.0 (RFC 2784) for general encapsulation using GRE

In this menu you can configure a virtual interface for using GRE V.0. The data traffic routed over this interface is then encapsulated using GRE and sent to the specified recipient.

11.4.1 GRE Tunnels

In the **VPN -> GRE -> GRE Tunnels** menu, a list of all configured GRE tunnels is shown.

11.4.1.1 New

Choose the **New** button to set up new GRE tunnels.

Fig. 141: VPN -> GRE -> GRE Tunnels

The **VPN -> GRE -> GRE Tunnels** menu consists of the following fields:

Fields in the GRE Tunnels Basic Parameters menu

Field	Description
Description	Enter a description for the GRE tunnel.
Local GRE IP Address	Enter the source IP address of the GRE packets to the GRE partner. If no IP address is given (this corresponds to IP address 0.0.0.0), the source IP address of the GRE packets is selected automatically from one of the addresses of the interface via which the GRE partner is reached.
Remote GRE IP Address	Specify the destination IP address of the host or network to which the packets are to be sent through the GRE tunnel.
Default Route	If you enable the Default Route , all data is automatically routed to a connection. The function is disabled by default.

Field	Description
Local IP Address	Enter the IP address to be used as the source address for this GRE connection.
Route Entries	<p>Define other routing entries for this connection partner.</p> <p>Add a new entry with Add.</p> <ul style="list-style-type: none"> • <i>Remote IP Address</i>: IP address of the destination host or network. • <i>Netmask</i>: Netmask of Remote IP Address. If no entry is made, your device uses a default netmask. • <i>Metric</i>: The lower the value, the higher the priority of the route (possible values 0... 15). The default value is 1.
MTU	<p>Enter the maximum packet size (Maximum Transfer Unit, MTU) in bytes that is allowed for the GRE connection between the partners.</p> <p>Possible values are 1 to 8192.</p> <p>The default value is 1500.</p>
Use Key	<p>Enable the key input for the GRE connection, which makes it possible to distinguish between several parallel GRE connections between two GRE partners (see RFC 1701).</p> <p>The key is activated with <i>Enable</i>.</p> <p>The function is disabled by default.</p>
Key Value	<p>Only if Use Key is enabled.</p> <p>Enter the GRE connection key.</p> <p>Possible values are 0 to 2147483647.</p> <p>The default value is 0.</p>

11.5 Certificates

11.5.1 Certificate list

In the **VPN -> Certificates -> Certificate List** menu a list of all available certificates is shown.

11.5.1.1 Edit

Click the  icon to display the content of the selected object (key, certificate, or request).

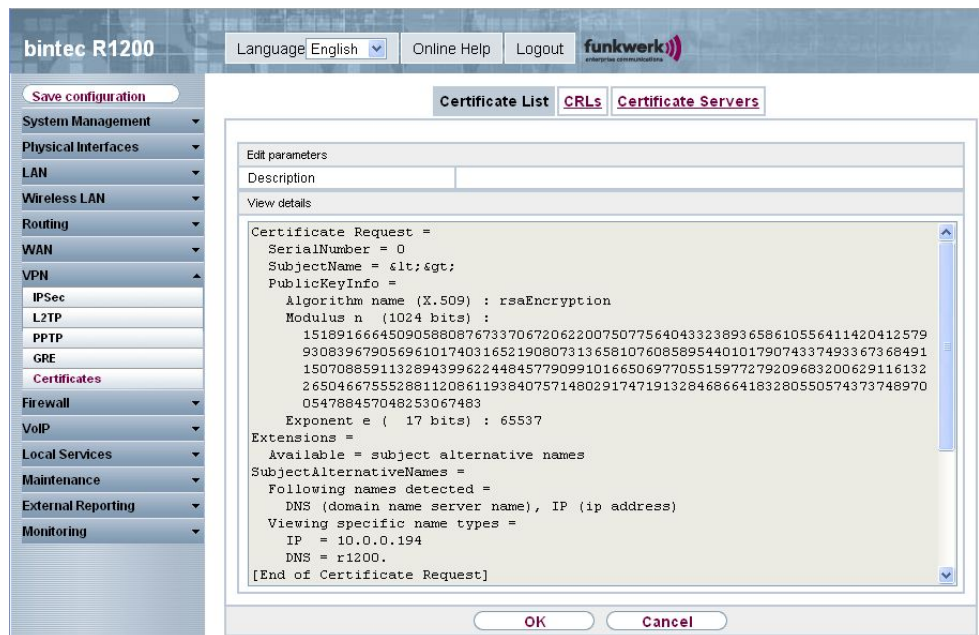

Fig. 142: VPN -> Certificates -> Certificate List->

The certificates and keys themselves cannot be changed, but a few external attributes can be changed, depending on the type of the selected entry.

The **VPN -> Certificates -> Certificate List ->** menu consists of the following fields:

Fields in the menu

Field	Description
Description	Shows the name of the certificate, key, or request.
Certificate is CA Certificate	Mark the certificate as a certificate from a trustworthy certification authority (CA).

Field	Description
	<p>Certificates issued by this CA are accepted during authentication (unless specified otherwise under "Phase-1 Profiles").</p> <p>The function is activated with <i>True</i>.</p> <p>The function is disabled by default.</p>
Certificate Revocation List (CRL) Checking	<p>Only for Certificate is a CA certificate = <i>True</i>.</p> <p>Define the extent to which certificate revocation lists (CRLs) are to be included in the validation of certificates issued by the owner of this certificate.</p> <p>Possible settings:</p> <ul style="list-style-type: none"> • <i>Disabled</i>: No checking of CRLs. • <i>Always</i>: CRLs are always checked. • <i>Only if a CRL Distribution Point is present</i> (default value): A check is only carried out if a CRL Distribution Point entry is included in the certificate. This can be determined under "View Details" in the certificate content. • <i>Use Settings from superior certificate</i>: The settings of the higher level certificate are used, if one exists. If it does not, the same procedure is used as that described under "Only if a CRL Distribution Point is present".
Force Certificate to be trusted	<p>Define that this certificate is to be accepted as the user certificate without further checks during authentication.</p> <p>The function is activated with <i>True</i>.</p> <p>The function is disabled by default.</p>



Caution

It is extremely important for VPN security that the integrity of all certificates manually marked as trustworthy (certification authority and user certificates) is ensured. The displayed "fingerprints" can be used to check this integrity: Compare the displayed values with the fingerprints specified by the issuer of the certificate (e.g. on the Internet). It is sufficient to check one of the two values.

11.5.1.2 Request

Registration authority certificates in SCEP

If SCEP is used, your device also supports separate registration authority certificates.

Registration authority certificates are used by some Certificate Authorities (CAs) to handle certain tasks (signature and encryption) during SCEP communication with separate keys, and to delegate the operation to separate registration authorities, if applicable.

When a certificate is downloaded automatically, i.e. if **CA Certificates** = *-Download-* is selected, all the certificates needed for the operation are loaded automatically.

If all the necessary certificates are already available in the system, these can also be selected manually.

Select the **Request** button to request or import more certificates.

The screenshot shows the 'bintec R1200' web interface. The top navigation bar includes 'Language English', 'Online Help', 'Logout', and the 'funkwerk' logo. The left sidebar contains a menu with categories like 'System Management', 'Physical Interfaces', 'LAN', 'Wireless LAN', 'Routing', 'WAN', 'VPN', 'Firewall', 'VoIP', 'Local Services', 'Maintenance', 'External Reporting', and 'Monitoring'. The 'VPN' category is expanded, showing sub-items like 'IPSec', 'L2TP', 'PPTP', 'GRE', 'Certificates', 'Firewall', 'VoIP', 'Local Services', 'Maintenance', 'External Reporting', and 'Monitoring'. The 'Certificates' sub-item is selected, leading to the 'Certificate List' menu, which has three tabs: 'Certificate List', 'CRLs', and 'Certificate Servers'. The 'Certificate List' tab is active, showing a 'Certificate Request' form. The form has the following fields:

- Certificate Request Description: Text input field.
- Mode: Radio buttons for 'Manual' (selected) and 'SCEP'.
- Generate Private Key: 'RSA' dropdown and '1024 Bits' dropdown.
- Subject Name: Section with a 'Custom' checkbox (unchecked) and 'Enabled' checkbox (checked).
- Common Name: Text input field.
- E-mail: Text input field.
- Organizational Unit: Text input field.
- Organization: Text input field.
- Locality: Text input field.
- State/Province: Text input field.
- Country: Text input field.

Below the main form is an 'Advanced Settings' section with the following fields:

- Subject Alternative Names: Three rows, each with a dropdown menu (all set to 'None') and a text input field.
- Options: Section with an 'Autosave Mode' checkbox (checked) and 'Enabled' checkbox (checked).

At the bottom of the form are 'OK' and 'Cancel' buttons.

Fig. 143: VPN ->Certificates ->Certificate List -> Request

The VPN -> Certificates -> Certificate List -> Request menu consists of the following fields:

Fields in the Certificate List Certificate Request menu

Field	Description
Certificate Request Description	Enter a unique description for the certificate.
Mode	Select the way in which you want to request the certificate. Possible settings: <ul style="list-style-type: none"> <i>Manual</i> (default value): Your device generates a PKCS#10 for the key. This file can then be uploaded directly in the browser or copied in the Edit menu using the View Details field. This file must be provided to the CA and the received

Field	Description
	<p>certificate must then be imported manually to your device.</p> <ul style="list-style-type: none"> • <i>SCEP</i> : The key is requested from a CA using the Simple Certificate Enrolment Protocol.
Generate Private Key	<p>Only if Mode = <i>Manual</i>.</p> <p>Select an algorithm for key creation.</p> <p><i>RSA</i> (default value) and <i>DSA</i> are available.</p> <p>Also select the length of the key to be created.</p> <p>Possible values: <i>512, 768, 1024, 1536, 2048, 4096</i>.</p> <p>Please note that a key with a length of 512 bits could be rated as unsecure, whereas a key of 4096 bits not only needs a lot of time to create, but also occupies a major share of the resources during IPSec processing. A value of 768 or more is, however, recommended and the default value is 1024 bits.</p>
SCEP URL	<p>Only if Mode = <i>SCEP</i>.</p> <p>Enter the URL of the SCEP server, e.g. <code>http://scep.funkwerk.de:8080/scep/scep.dll</code></p> <p>Your CA administrator can provide you with the necessary data.</p>
CA Certificate	<p>Only if Mode = <i>SCEP</i>.</p> <p>Select the CA certificate.</p> <ul style="list-style-type: none"> • <i>-Download-</i>: In CA Name, enter the name of the CA certificate of the certification authority (CA) from which you wish to request your certificate, e.g. <i>cawindows</i>. Your CA administrator can provide you with the necessary data. <p>If no CA certificates are available, the device will first download the CA certificate of the relevant CA. It then continues with the enrolment process, provided no more important parameters are missing. In this case, it returns to the Generate Certificate Request menu.</p> <p>If the CA certificate does not contain a CRL distribution point (Certificate Revocation List, CRL), and a certificate server is not configured on the device, the validity of certificates from</p>

Field	Description
	<p>this CA is not checked.</p> <ul style="list-style-type: none"> <name of an existing certificate>: If all the necessary certificates are already available in the system, you select these manually.
RA Sign Certificate	<p>Only if Mode = <i>SCEP</i>.</p> <p>Only if CA Certificates is not = <i>-Download-</i>.</p> <p>Select a certificate for signing SCEP communication.</p> <p>The default value is <i>-Use CA Certificate-</i>, i.e. the CA certificate is used.</p>
RA Encrypt Certificate	<p>Only if Mode = <i>SCEP</i>.</p> <p>Only if RA Sign Certificate is not = <i>-Use CA Certificate-</i>.</p> <p>If you use one of your own certificates to sign communication with the RA, you can select another one here to encrypt communication.</p> <p>The default value is <i>-Use RA Sign Certificate-</i>, i.e. the same certificate is used as for signing.</p>
Password	<p>Only if Mode = <i>SCEP</i>.</p> <p>You may need a password from the certification authority to obtain certificates for your keys. Enter the password you received from the certification authority here.</p>

Fields in the Certificate List Subject Name menu

Field	Description
Custom	<p>Select whether you want to enter the name components of the subject name individually as specified by the CA or want to enter a special subject name.</p> <p>If <i>Enabled</i> is selected, a subject name can be given in Condensed with attributes that are not offered in the list. Example: "CN=VPNServer, DC=mydomain, DC=com, c=DE".</p> <p>If the field is not marked, enter the name components in General name, e-mail, Organisational Unit, Organisation, Locality,</p>

Field	Description
	<p>State/Province and Country.</p> <p>The function is disabled by default.</p>
Summary	<p>Only for Custom = enabled.</p> <p>Enter a subject name with attributes not offered in the list.</p> <p>Example: "CN=VPNServer, DC=mydomain, DC=com, c=DE".</p>
Common Name	<p>Only for Custom = disabled.</p> <p>Enter the name according to CA.</p>
E-mail	<p>Only for Custom = disabled.</p> <p>Enter the e-mail address according to CA.</p>
Organisational Unit	<p>Only for Custom = disabled.</p> <p>Enter the organisational unit according to CA.</p>
Organisation	<p>Only for Custom = disabled.</p> <p>Enter the organisation according to CA.</p>
Locality	<p>Only for Custom = disabled.</p> <p>Enter the location according to CA.</p>
State/Province	<p>Only for Custom = disabled.</p> <p>Enter the state/province according to CA.</p>
Country	<p>Only for Custom = disabled.</p> <p>Enter the country according to CA.</p>

The **Advanced Settings** menu consists of the following fields:

Fields in the Advanced Settings Alternative Subject Name menu

Field	Description
#1, #2, #3	For each entry, define the type of name and enter additional subject names.

Field	Description
	<p>Possible values:</p> <ul style="list-style-type: none"> • <i>None</i> (default value): No additional name is entered. • <i>IP</i>: An IP address is entered. • <i>DNS</i>: A DNS name is entered. • <i>Email</i>: An e-mail address is entered. • <i>URI</i>: A uniform resource identifier is entered. • <i>DN</i>: A distinguished name (DN) name is entered. • <i>RID</i>: A registered identity (RID) is entered.

Fields in the Advanced Settings Options menu

Field	Description
Autosave Mode	<p>Select whether your device automatically stores the various steps of the enrolment internally. This is an advantage if enrolment cannot be concluded immediately. If the status has not been saved, the enrolment cannot be completed. As soon as the enrolment is completed and the certificate has been downloaded from the CA server, it is automatically saved in the device configuration.</p> <p>The function is activated with <i>Enabled</i>.</p> <p>The function is enabled by default.</p>

11.5.1.3 Import

Choose the **Import** button to import other certificates.

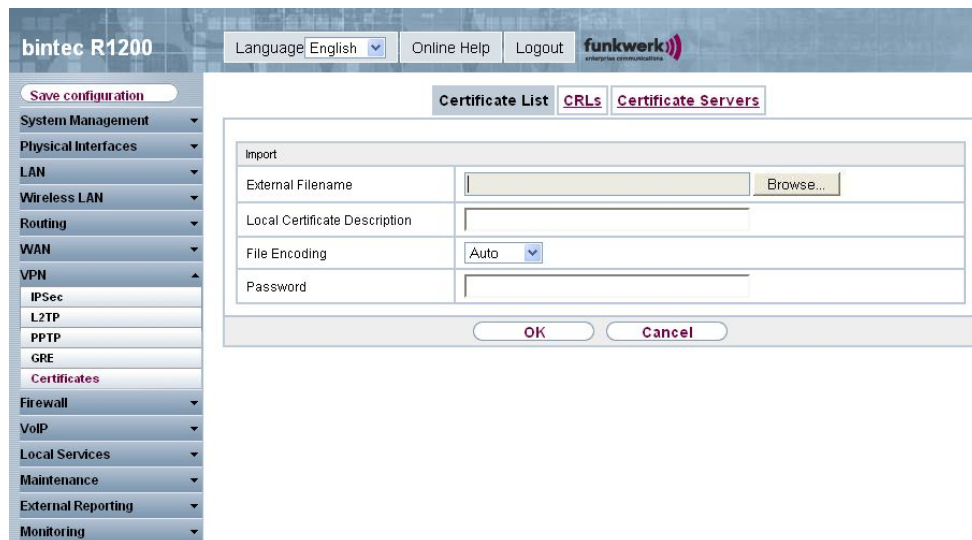

Fig. 144: VPN ->Certificates ->Certificate List -> Import

The VPN -> Certificates -> Certificate List -> Import menu consists of the following fields:

Fields in the Certificate List Import menu

Field	Description
External Filename	Enter the file path and name of the certificate to be imported, or use Browse... to select it from the file browser.
Local Certificate Description	Enter a unique description for the certificate.
File Encoding	Select the type of coding so that your device can decode the certificate. Possible values: <ul style="list-style-type: none"> • <i>auto</i> (default value) Activates automatic code recognition. If downloading the certificate in auto mode fails, try with a certain type of encoding. • <i>Base64</i> • <i>Binary</i>
Password	You may need a password to obtain certificates for your keys. Enter the password here.

11.5.2 CRLs

In the **VPN -> Certificates -> CRLs** menu a list of all CRLs is shown.

11.5.2.1 Import

Choose the **Import** button to import other CRLs.

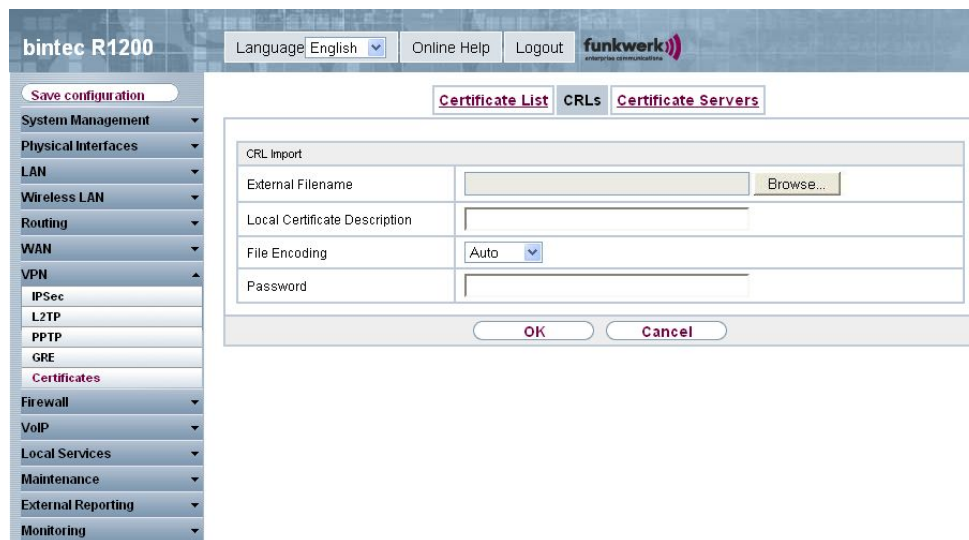

Fig. 145: **VPN -> Certificates -> CRLs-> Import**

The **VPN -> Certificates -> CRLs -> Import** menu consists of the following fields:

Fields in the CRLs CRL Import menu

Field	Description
External Filename	Enter the file path and name of the CRL to be imported, or use Browse... to select it from the file browser.
Local Certificate Description	Enter a unique description for the CRL.
File Encoding	Select the type of encoding, so that your device can decode the CRL. Possible values: <ul style="list-style-type: none"> <code>auto</code> (default value) Activates automatic code recognition. If

Field	Description
	<p>downloading the CRL in auto mode fails, try with a certain type of encoding.</p> <ul style="list-style-type: none"> • <i>Base64</i> • <i>Binary</i>
Password	Enter the password to be used for the import.

11.5.3 Certificate Servers

In the **VPN -> Certificates -> Certificate Servers** menu a list of all certificate servers is shown.

11.5.3.1 New

Choose the **New** button to set up new certificate servers.



Fig. 146: VPN -> Certificates -> Certificate Servers -> New

The **VPN -> Certificates -> Certificate Servers -> New** menu consists of the following fields:

Fields in the Certificate Servers Basic Parameters menu

Field	Description
Description	Enter a unique description for the certificate server.
LDAP URL Path	Enter the LDAP URL of the server.

Chapter 12 Firewall

The Stateful Inspection Firewall (SIF) provided for **bintec** gateways is a powerful security feature.

The SIF with dynamic packet filtering has a decisive advantage over static packet filtering: The decision whether or not to send a packet cannot be made solely on the basis of source and destination addresses or ports but also using dynamic packet filtering based on the state of the connection to a partner.

This means packets that belong to an already active connection can also be forwarded. The SIF also accepts packets that belong to an "affiliated connection". The negotiation of an FTP connection takes place over port 21, for example, but the actual data exchange can take place over a completely different port.

SIF and other security features

bintec's Stateful Inspection Firewall fits into the existing security architecture of **bintec** device very well due to its simple configuration. The configuration work for the SIF is comparatively straightforward with systems like Network Address Translation (NAT) and IP Access Lists (IPAL).

As SIF, NAT and IPAL are active in the system simultaneously, attention must be given to possible interaction: If any packet is rejected by one of the security instances, this is done immediately. This is irrelevant whether another instance would accept it or not. Your need for security features should therefore be accurately analysed.

The essential difference between SIF and NAT/IPAL is that the rules for the SIF are generally applied globally, i.e. not restricted to one interface.

In principle, the same filter criteria are applied to the data traffic as those used in NAT and IPAL:

- Source and destination address of the packet (with an associated netmask)
- Service (preconfigured, e.g. Echo, FTP, HTTP)
- Protocol
- Port number(s)

To illustrate the differences in packet filtering, a list of the individual security instances and their method of operation is given below:

NAT

One of the basic functions of NAT is the translation of the local IP addresses of your LAN into the global IP addresses you are assigned by your ISP and vice versa. All connections initiated externally are first blocked, i.e. every packet your device cannot assign to an existing connection is rejected. This means that a connection can only be set up from inside to outside. Without explicit permission, NAT rejects every access from the WAN to the LAN.

IP Access Lists

Here packets are permitted or rejected exclusively on the basis of the criteria listed above, i.e. the state of the connection is not considered (except where **Services** = *tcp*).

SIF

The SIF sorts out all packets that are not explicitly or implicitly allowed. The result can be a "deny", in which case no error message is sent to the sender of the rejected packet, or a "reject", where the sender is informed of the packet rejection.

The incoming packets are processed as follows:

- The SIF first checks if an incoming packet can be assigned to an existing connection. If so, it is forwarded. If the packet cannot be assigned to an existing connection, a check is made to see if a suitable connection is expected (e.g. as affiliated connection of an existing connection). If so, the packet is also accepted.
- If the packet cannot be assigned to any existing or expected connection, the SIF filter rules are applied: If a deny rule matches the packet, the packet is rejected without sending an error message to the sender of the packet; if a reject rule matches, the packet is rejected and an ICMP Host Unreachable message sent to the sender of the packet. The packet is only forwarded if an accept rule matches.
- All packets without matching rules are rejected without sending an error message to the sender when all the existing rules have been checked (=default behaviour).

12.1 Policies

12.1.1 Filter Rules

The default behaviour with **Action** = *Access* consists of two implicit filter rules: If an incoming packet can be assigned to an existing connection and if a suitable connection is expected (e.g. such as an affiliated connection of an existing connection), the packet is allowed.

The sequence of filter rules in the list is relevant: The filter rules are applied to each packet in succession until a rule matches. If overlapping occurs, i.e. more than one filter rule matches a packet, only the first rule is executed. This means that if the first rule denies a packet, whereas a later rule allows it, the packet is rejected. A deny rule also has no effect if a relevant packet has previously been allowed by another filter rule.

In the **Firewall -> Policies -> Filter Rules** menu, a list of all configured filter rules is shown. Select the show administrative access rules option to display existing filter rules for administrative access to your device (see **System Management -> Administrative Access -> Access**). These rules can also be edited here.

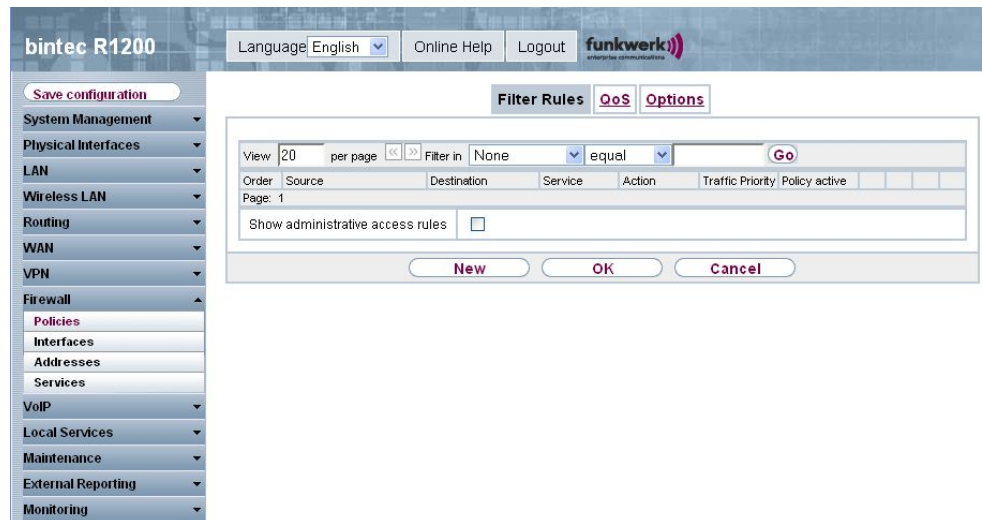



Fig. 147: Firewall -> Policies -> Filter Rules

You can use the  button to insert another policy above the list entry. The configuration menu for creating a new policy opens.

You can use the  button to move the list entry. A dialog box opens, in which you can select the position to which the policy is to be moved.

12.1.1.1 New

Choose the **New** button to set up new parameters.

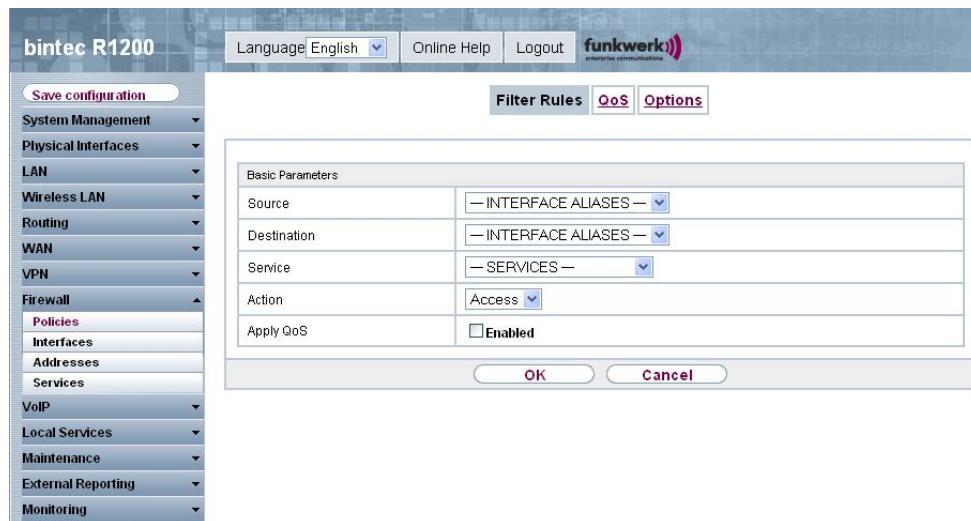

Fig. 148: Firewall -> Policies -> Filter Rules -> New

The **Firewall -> Policies -> Filter Rules -> New** menu consists of the following fields:

Fields in the Policies Basic Parameters menu

Field	Description
Source	<p>Select one of the preconfigured aliases for the source of the packet.</p> <p>The list includes all WAN-/LAN interfaces, interface groups (see Firewall -> Interfaces -> Groups), addresses (see Firewall -> Addresses -> Address List) and address groups (see Firewall -> Addresses -> Groups) for selection.</p> <p>The value <i>Any</i> means that neither the source interface nor the source address is checked.</p>
Destination	<p>Select one of the preconfigured aliases for the destination of the packet.</p> <p>The list includes all WAN-/LAN interfaces, interface groups (see Firewall -> Interfaces -> Groups), addresses (see Firewall -> Addresses -> Address List) and address groups (see Firewall -> Addresses -> Groups) for selection.</p>

Field	Description
	<p>The value <i>Any</i> means that neither the destination interface nor the destination address is checked.</p>
Service	<p>Select one of the preconfigured services to which the packet to be filtered must be assigned.</p> <p>The extensive range of services configured ex works includes the following:</p> <ul style="list-style-type: none"> • <i>FTP</i> • <i>TELNET</i> • <i>SMTP</i> • <i>DNS</i> • <i>HTTP</i> • <i>NNTP</i> • <i>Internet</i> • <i>Netmeeting</i> <p>Other services are set up in Firewall -> Services -> Service List.</p> <p>In addition, the service groups configured in Firewall -> Services -> Groups can be selected.</p>
Action	<p>Select the action to be applied to a filtered packet.</p> <p>Possible values:</p> <ul style="list-style-type: none"> • <i>Access</i> (default value): The packets are forwarded on the basis of the entries. • <i>Deny</i> : The packets are rejected. • <i>Reject</i> : The packets are rejected. An error message is issued to the sender of the packet.
Apply QoS	<p>Only for Action = <i>Access</i></p> <p>Select whether you want to enable QoS for this policy with the priority selected in Data Traffic Priority</p> <p>The function is activated with <i>Enabled</i>.</p> <p>The option is deactivated by default.</p>

Field	Description
	<p>If QoS is not activated for this policy, bear in mind that the data cannot be prioritised on the sender side either.</p> <p>A policy with QoS activated is not only used for QoS, but for the firewall, too. Bear in mind, that traffic that is not explicitly allowed, is blocked by the firewall!</p>
Traffic Priority	<p>Only for Apply QoS = <i>enabled</i></p> <p>Select the priority with which the data specified by the policy is handled on the send side.</p> <p>Possible values:</p> <ul style="list-style-type: none"> • <i>None</i> (default value): No priority. • <i>Low Latency</i>: Low Latency Transmission (LTT), i.e. handling of data with the lowest possible latency, e.g. suitable for VoIP data. • <i>High</i> • <i>Medium</i> • <i>Low</i>

12.1.2 QoS

More and more applications need increasingly larger bandwidths, which are not always available. Quality of Service (QoS) makes it possible to distribute the available bandwidths effectively and intelligently. Certain applications can be given preference and bandwidth reserved for them.

In the **Firewall** -> **Policies** -> **QoS** menu, a list of all QoS rules is shown.

12.1.2.1 New

Choose the **New** button to set up new QoS rules.

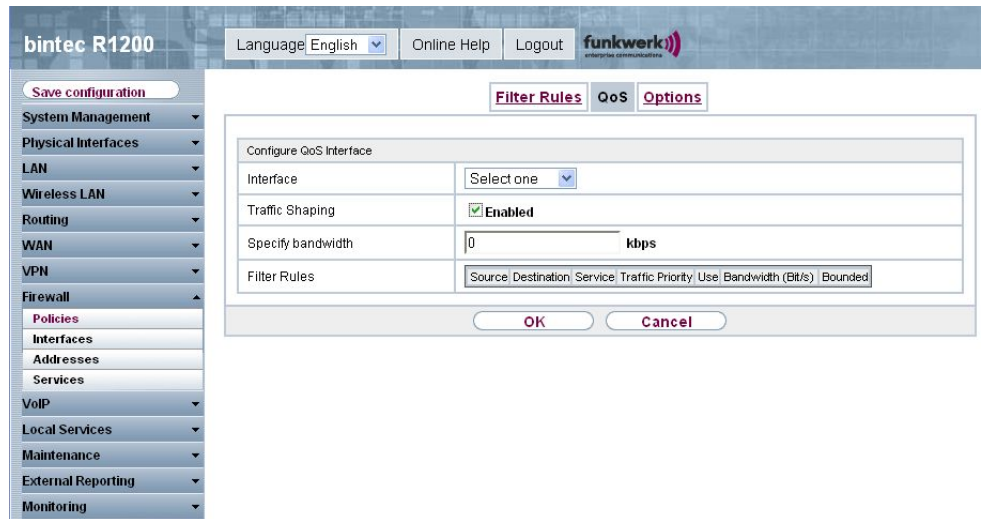

Fig. 149: Firewall -> Policies -> QoS -> New

The Firewall -> Policies -> QoS -> New menu consists of the following fields:

Fields in the QoS Configure QoS Interface menu

Field	Description
Interface	Select the interface on which bandwidth management is to be carried out.
Traffic Shaping	Select whether you want to activate bandwidth management for the selected interface. The function is activated with <i>Enabled</i> . The function is disabled by default.
Specify bandwidth	Only for Traffic Shaping = <i>Enabled</i> . Enter the maximum available bandwidth in kbps for the selected interface.
Filter Rules	This field contains a list of all configured firewall policies for which QoS was enabled (Apply QoS = <i>Enabled</i>). The following options are available for each list entry: <ul style="list-style-type: none"> • Use: Select whether this entry should be assigned to the QoS interface. The option is deactivated by default. • Bandwidth: Enter the maximum available bandwidth in kbps

Field	Description
	<p>for the service specified under Services. <i>0</i> is entered by default.</p> <ul style="list-style-type: none"> • Bounded: Select whether the bandwidth defined in Bandwidth can be exceeded in the longer term. By activating this field, you specify that it cannot be exceeded. If the option is deactivated, the bandwidth can be exceeded and the excess data rate is handled in accordance with the priority defined in the firewall policy. The option is deactivated by default.

12.1.3 Options

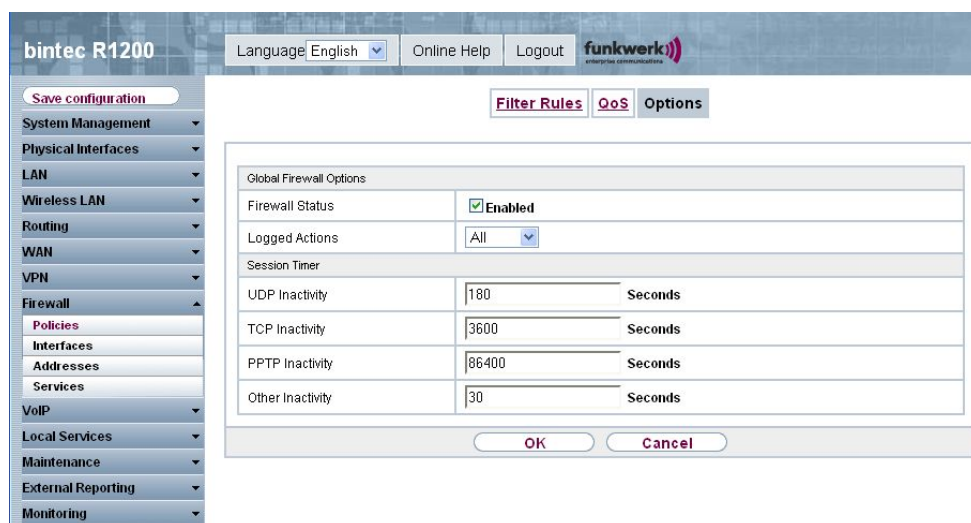

Fig. 150: Firewall -> Policies ->Options

The Firewall -> Policies -> Options menu consists of the following fields:

Fields in the Options Global Firewall Options menu

Field	Description
Firewall Status	<p>Enable or disable the firewall function.</p> <p>The function is activated with <i>Enabled</i>.</p> <p>The function is enabled by default.</p>
Logged Actions	Select the firewall syslog level.

Field	Description
	<p>The messages are output together with messages from other subsystems.</p> <p>Possible values:</p> <ul style="list-style-type: none"> • <i>All</i> (default value): All firewall activities are displayed. • <i>Deny</i>: Only reject and deny events are shown, see "Action". • <i>Accept</i>: Only accept events are shown. • <i>None</i>: Syslog messages are not generated.

Fields in the Options Session Timer menu

Field	Description
UDP Inactivity	<p>Enter the inactivity time after which a UDP session is to be regarded as expired (in seconds).</p> <p>Possible values are 30 to 86400.</p> <p>The default value is 180.</p>
TCP Inactivity	<p>Enter the inactivity time after which a TCP session is to be regarded as expired (in seconds).</p> <p>Possible values are 30 to 86400.</p> <p>The default value is 3600.</p>
PPTP Inactivity	<p>Enter the inactivity time after which a PPTP session is to be regarded as expired (in seconds).</p> <p>Possible values are 30 to 86400.</p> <p>The default value is 86400.</p>
Other Inactivity	<p>Enter the inactivity time after which a session of another type is to be regarded as expired (in seconds).</p> <p>Possible values are 30 to 86400.</p> <p>The default value is 30.</p>

12.2 Interfaces

12.2.1 Groups

In the **Firewall -> Interfaces -> Groups** menu, a list of all configured interface groups is shown.

You can group together the interfaces of your device. This makes it easier to configure fire-wall rules.

12.2.1.1 New

Choose the **New** button to set up new interface groups.

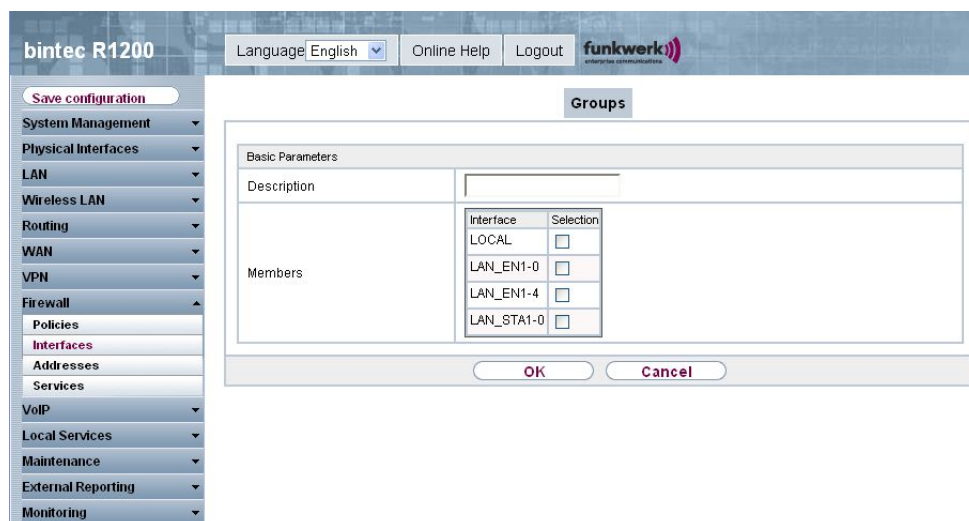

Fig. 151: Firewall -> Interfaces ->Groups-> New

The **Firewall -> Interfaces -> Groups-> New** menu consists of the following fields:

Fields in the Groups Basic Parameters menu

Field	Description
Description	Enter the desired description of the interface group.
Members	Select the members of the group from the available interfaces. To do this, enable the field in the Members column.

12.3 Addresses

12.3.1 Address list

In the **Firewall -> Addresses -> Address List** menu, a list of all configured addresses is shown.

12.3.1.1 New

Choose the **New** button to set up new addresses.

The screenshot shows the bintec R1200 web interface. The top navigation bar includes 'Language English', 'Online Help', 'Logout', and the 'funkwerk' logo. The left sidebar shows a menu with 'Firewall' expanded to 'Addresses'. The main content area displays the 'Address List' configuration window. The window has a 'Basic Parameters' section with the following fields:

- Description: A text input field.
- Address Type: Radio buttons for 'Address / Subnet' (selected) and 'Address Range'.
- Address / Subnet: Two input fields separated by a slash, for entering an IP address and subnet mask.

At the bottom of the window are 'OK' and 'Cancel' buttons.

Fig. 152: Firewall -> Addresses -> Address List-> New

The **Firewall -> Addresses -> Address List-> New** menu consists of the following fields:

Fields in the Address List Basic Parameters menu

Field	Description
Description	Enter the desired description of the address.
Address Type	Select the type of address you want to specify. Possible values: <ul style="list-style-type: none"> <i>Address / Subnet</i> (default value): Enter an IP address with subnet mask. <i>Address Range</i>: Enter an IP address range with a start and end address.

Field	Description
Address / Subnet	<p>Only if Address Type = <i>Address / Subnet</i></p> <p>Enter the IP address of the host or a network address and the related netmask.</p> <p>The default value is <i>0.0.0.0</i>.</p>
Address Range	<p>Only if Alias Type = <i>Address Range</i></p> <p>Enter the start and end IP address of the range.</p>

12.3.2 Groups

In the **Firewall -> Addresses -> Groups** menu, a list of all configured address groups is shown.

You can group together addresses. This makes it easier to configure firewall rules.

12.3.2.1 New

Choose the **New** button to set up new address groups.

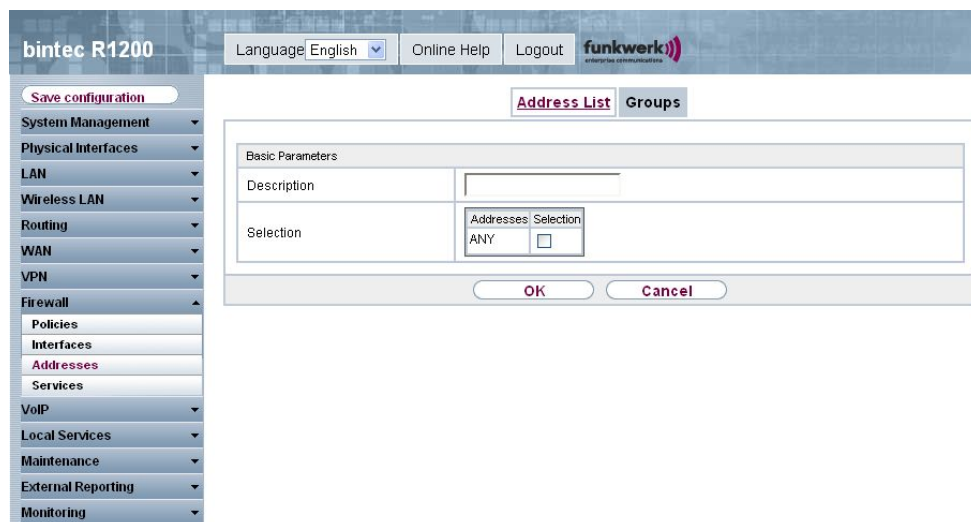

Fig. 153: Firewall -> Addresses -> Groups -> New

The **Firewall -> Addresses -> Groups -> New** menu consists of the following fields:

Fields in the Groups Basic Parameters menu

Field	Description
Description	Enter the desired description of the address group.
Selection	Select the members of the group from the available Addresses . To do this, enable the field in the Selection column.

12.4 Services

12.4.1 Service list

In the **Firewall** -> **Services** -> **Service List** menu, a list of all available services is shown.

12.4.1.1 New

Choose the **New** button to set up new services.

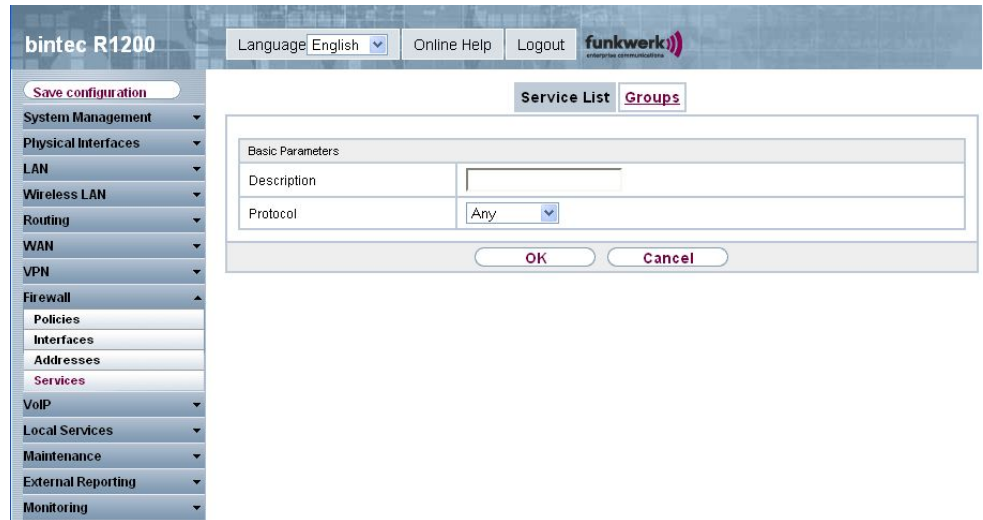

Fig. 154: Firewall -> Services -> Service List-> New

The **Firewall** -> **Services** -> **Service List**-> **New** menu consists of the following fields:

Fields in the Service List Basic Parameters menu

Field	Description
Description	Enter an alias for the service you want to configure.

Field	Description
Protocol	Select the protocol on which the service is to be based. The most important protocols are available for selection.
Destination Port Range	<p>Only if Protocol = <i>TCP</i> , <i>UDP/TCP</i> or <i>UDP</i></p> <p>In the first field, enter the destination port via which the service is to run.</p> <p>If a port number range is specified, in the second field enter the last port of the port range. By default the field does not contain an entry. If a value is displayed, this means that the previously specified port number is verified. If a port range is to be checked, enter the upper limit here.</p> <p>Possible values are <i>1</i> to <i>65535</i>.</p>
Source Port Range	<p>Only if Protocol = <i>TCP</i> , <i>UDP/TCP</i> or <i>UDP</i></p> <p>In the first field, enter the source port to be checked, if applicable.</p> <p>If a port number range is specified, in the second field enter the last port of the port range. By default the field does not contain an entry. If a value is displayed, this means that the previously specified port number is verified. If a port range is to be checked, enter the upper limit here.</p> <p>Possible values are <i>1</i> to <i>65535</i>.</p>
Type/Code	<p>Only if Protocol = <i>ICMP</i></p> <p>The Type field shows the class of ICMP messages, the Code field specifies the type of message in greater detail.</p> <p>Possible values:</p> <ul style="list-style-type: none"> • <i>Any</i> (default value) • <i>Echo Replay</i> • <i>Destination Unreachable</i> • <i>Source Quench</i> • <i>Redirect</i> • <i>Echo</i> • <i>Time Exceeded</i>

Field	Description
	<ul style="list-style-type: none"> • <i>Parameter Problem</i> • <i>Timestamp</i> • <i>Timestamp Reply</i> • <i>Information Request</i> • <i>Information Reply</i> • <i>Address Mask Request</i> • <i>Address Mask Reply</i>
Code	<p>ICMP code options can only be selected if Type = <i>Destination Unreachable</i>.</p> <p>Possible values:</p> <ul style="list-style-type: none"> • <i>Any (default value)</i> • <i>Net Unreachable</i> • <i>Host Unreachable</i> • <i>Protocol Unreachable</i> • <i>Port Unreachable</i> • <i>Fragmentation Needed</i> • <i>Communication with Destination Network is Administratively Prohibited</i> • <i>Communication with Destination Host is Administratively Prohibited</i>

12.4.2 Groups

In the **Firewall** -> **Services** -> **Groups** menu, a list of all configured service groups is shown.

You can group together services. This makes it easier to configure firewall rules.

12.4.2.1 New

Choose the **New** button to set up new service groups.

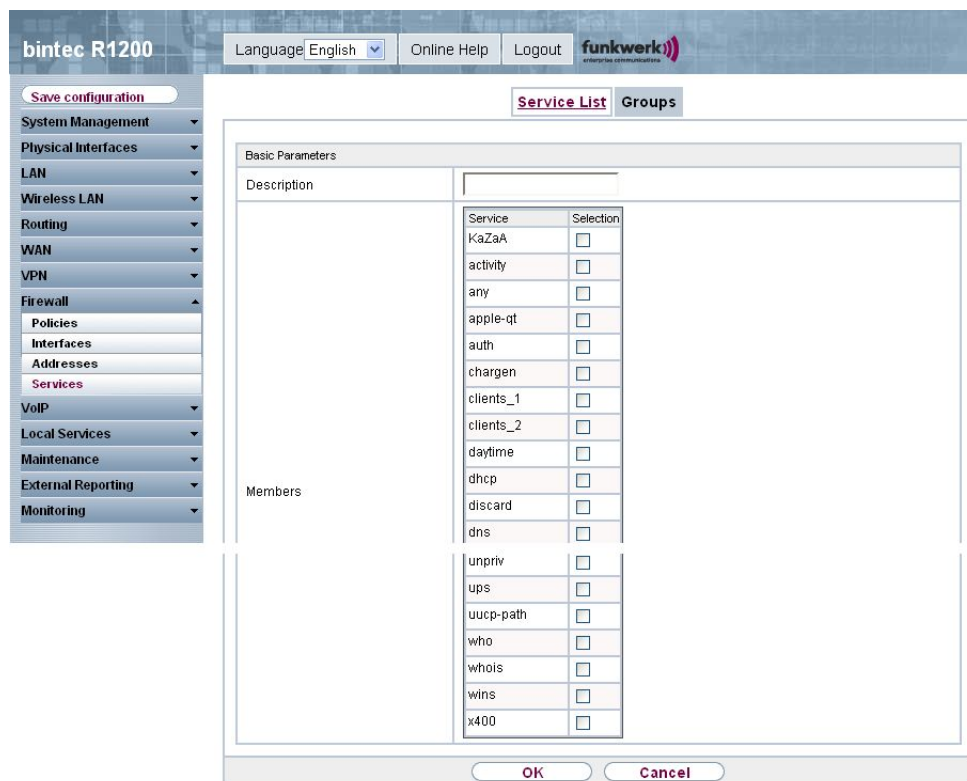

Fig. 155: Firewall -> Services -> Groups -> New

The Firewall -> Services -> Groups -> New menu consists of the following fields:

Fields in the Groups Basic Parameters menu

Field	Description
Description	Enter the desired description of the service group.
Members	Select the members of the group from the available service aliases. To do this, enable the field in the Members column.

Chapter 13 VoIP

Voice over IP (VoIP) uses the IP protocol for voice and video transmission.

The main difference compared with conventional telephony is that the voice information is not transmitted over a switched connection in a telephone network, but divided into data packets by the Internet protocol and these packets are then passed to the destination over undefined paths in a network. This technology uses the existing network infrastructure for voice transmission and shares this with other communication services.

13.1 Application Level Gateway

To enable IP telephones to connect by SIP to a VoIP Provider your device has an Application Level Gateway (ALG), i.e. an appropriate proxy that implements the necessary NAT and firewall releases.



Note

The Application Level Gateway must always be used if NAT is enabled on the interface that makes the connection to the Internet.

13.1.1 SIP Proxies

Here you can view a list of application level gateway entries that have already been configured. These entries enable the ALG. Each entry defines a particular TCP or UDP destination port that is to be supervised by the ALG. As normally delivered, there are two entries configured for the SIP Ports TCP 5060 and UDP 5060 in accordance with the IANA definition.

13.1.1.1 Edit/New

Choose the  icon to edit existing entries. Choose the **New** button to create application level gateway entries.

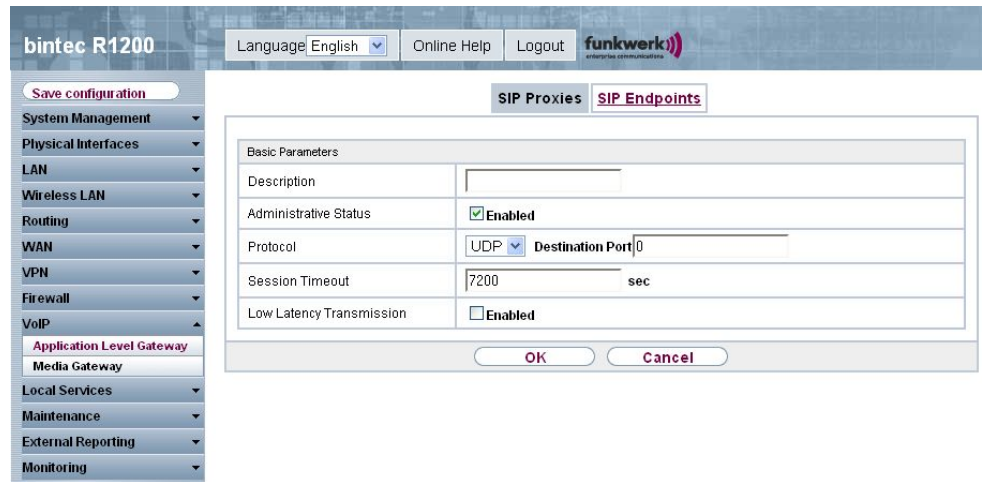

Fig. 156: VoIP -> Application Level Gateway -> SIP Proxies -> Edit/New

The VoIP->Application Level Gateway -> SIP Proxies -> Edit/New menu, consists of the following fields:

Fields in the SIP Proxies Basic Parameters menu

Field	Description
Description	Enter the name of the application level gateway.
Administrative Status	Select whether the SIP proxy should be enabled or disabled. The function is activated by choosing <i>Enabled</i> . The function is enabled by default.
Protocol	Select the protocol to be used. Possible values: <i>UDP</i> (default value) or <i>TCP</i> . Under Destination Port enter the port to be supervised by the proxy. or each destination port to which VoIP clients from the LAN can connect, you must configure a proxy.

Field	Description
	The ports can be provider-specific.
Session Timeout	<p>Enter the time in seconds for which a session stays up if no data packets are sent or received.</p> <p>This value must be greater than the SIP Expire Time of the connected SIP client (SIP telephone, terminal adapter etc.)</p> <p>The default value is <i>1800</i>.</p>
Low Latency Transmission	<p>Specify whether a mechanism should be used to minimise the transit time of VoIP data packets between two subscribers. This guarantees good voice quality with high line load.</p> <p>Note that Low Latency Transmission does not have to be switched on if the media gateway supervises the VoIP connection.</p> <p>The function is activated by choosing <i>Enabled</i>.</p> <p>The function is disabled by default.</p>

13.1.2 SIP Endpoints

Shows the sessions that are currently being managed by ALG.



Note

All clients that are not used for longer than 24 hours are automatically deleted from the table.

13.1.2.1 Edit/New

Choose the  icon to edit existing entries. Choose the **New** button to add static entries for SIP servers / proxies in the LAN that are to be accessible across the NAPT barrier.

Only if terminals are to be logged into externally on an internal server, you must enter values for the SIP server.

The screenshot shows the configuration interface for a bintec R1200 device. The left sidebar contains a navigation menu with categories like System Management, Physical Interfaces, LAN, Wireless LAN, Routing, WAN, VPN, Firewall, VoIP, Application Level Gateway, Media Gateway, Local Services, Maintenance, External Reporting, and Monitoring. The top bar includes 'Language English', 'Online Help', 'Logout', and the 'funkwerk' logo. The main content area has two tabs: 'SIP Proxies' and 'SIP Endpoints'. The 'SIP Endpoints' tab is selected, displaying a 'Basic Parameters' form. The form contains the following fields:

- Type of Endpoint: Radio buttons for Client and Server.
- Protocol: A dropdown menu showing 'UDP'.
- Internal IP Address: An empty text input field.
- Remote Port: A text input field containing '0'.
- External Port: A text input field containing '0'.

At the bottom of the form are 'OK' and 'Cancel' buttons.

Fig. 157: VoIP -> Application Level Gateway -> SIP Endpoints->Edit/New

The **VoIP->Application Level Gateway -> SIP Endpoints-> Edit/New** menu, consists of the following fields:

Fields in the SIP Endpoints Basic Parameters menu

Field	Description
Type of Endpoint	Select the SIP terminal to be used. Possible values: <i>Client</i> (default value): internal terminals (e.g. telephones) are used. <i>Server</i> : a server is used so that terminals can register from outside.
Protocol	Select the protocol to be used for data transmission. Possible values: <i>UDP</i> (default value) or <i>TCP</i> . If a protocol has been automatically recognised, it should not be changed.
Internal IP Address	Enter the internal IP address of the terminal.
Remote Port	Only for Type of Endpoint = <i>Client</i> . Enter the remote port.
Internal Port	Only for Type of Endpoint = <i>Server</i> . Enter the internal port.

Field	Description
External Port	External port that is to be bound to the internal port. For clients, the external port is recognised automatically and should not be changed.

13.2 Media Gateway

13.2.1 Extensions

Here you can configure the subscriber numbers of the terminal devices connected to the media gateway, i.e. the subscriber numbers of the SIP terminals and the subscriber numbers of the ISDN or analogue terminals, depending on the available PSTN interfaces.

In the **VoIP** -> **Media Gateway** -> **Extensions** menu, a list of all existing extensions is shown.

13.2.1.1 Edit/New

Choose the  icon to edit existing entries. Select the **New** button to create a new extension for terminals.

bintec R1200 Language English Online Help Logout **funkwerk**
enterprise communications

Save configuration

Extensions SIP Accounts Call Routing CLID Translation Call Translation Options

Basic Parameters

Description	<input type="text"/>
Extension / User Name	<input type="text"/>
Interface Type	<input checked="" type="radio"/> SIP
Registration	<input type="checkbox"/> Enabled
SIP Endpoint IP Address	<input type="text"/>
Authentication ID	<input type="text"/>
Password	<input type="text"/>
Protocol	UDP

Advanced Settings

Codec Settings

Codec Proposal Sequence Default Quality Lowest Highest

Sort Order	<input checked="" type="checkbox"/> G.711 uLaw	<input checked="" type="checkbox"/> G.711 aLaw	<input checked="" type="checkbox"/> G.729	<input type="checkbox"/> G.726-40
	<input type="checkbox"/> G.726-32	<input type="checkbox"/> G.726-24	<input type="checkbox"/> G.726-16	<input type="checkbox"/> DTMF Outband

Voice Quality Settings

Echo Cancellation	<input checked="" type="checkbox"/> Enabled
Comfort Noise Generation	<input checked="" type="checkbox"/> Enabled
Packet Size	30 ms

OK Cancel

Fig. 158: VoIP -> Media Gateway -> Extensions -> Edit/New

The VoIP -> Media Gateway -> Extensions -> Edit/New menu consists of the following fields:

Fields in the Extensions Basic Parameters menu

Field	Description
Description	Enter the name of the terminal.
Extension / User Name	Enter the subscriber number. A maximum of 40 characters can be entered.
Interface Type	Select the interface type to be used. The selection depends on the interfaces available.
Select ISDN interface	Only for Interface Type = ISDN. Select an ISDN interface. The ISDN interfaces you can select depends on the device used.

Field	Description
Select analogue interface	<p>Only for Interface Type = <i>Analogue</i>.</p> <p>Select an analogue interface. The analogue interfaces you can select depends on the device used.</p>
Registration	<p>Only for Interface Type = <i>SIP</i>.</p> <p>Specify whether the registration mechanism is to be used by SIP REGISTER. Normally, every SIP client (user) sends its current position to a REGISTRAR server by means of a REGISTER message. This information about the user and his current address is held by the REGISTRAR server and queried by other proxies to find the user.</p> <p>The function is activated with <i>Enabled</i>.</p> <p>The function is disabled by default.</p>
Expire Time	<p>Only if Registration is enabled.</p> <p>Enter the time in seconds after which the current registration becomes invalid and a new registration request is therefore sent.</p> <p>For clients, the external port is recognised automatically and should not be changed.</p> <p>Possible values are <i>0</i> to <i>38400</i>.</p> <p>The default value is <i>60</i>.</p>
SIP Endpoint IP Address	<p>Only if Registration is disabled.</p> <p>For configurations with no registration (e.g. connection to a Microsoft Exchange Communication Server) the connection can be set up as a static host. This requires you to specify the static IP address of the terminal.</p>
Authentication ID	<p>Only for Interface Type = <i>SIP</i></p> <p>Enter a name that is to be used for authentication. A maximum of 20 characters can be entered.</p> <p>The name given here must also be entered on the SIP telephone.</p> <p>If you do not enter a name, the name in the Extension / User</p>

Field	Description
	Name field is used.
Password	<p>Only for Interface Type = <i>SIP</i></p> <p>Enter a password here. A maximum of 20 characters can be entered.</p> <p>The password given here must also be entered on the SIP telephone.</p>
Protocol	<p>Select the protocol to be used for data transmission.</p> <p>Possible values: <i>udp</i> (default value) or <i>tcp</i>.</p> <p>If a protocol has been automatically recognised, it should not be changed.</p>

Fields in the Advanced Settings Codec Settings menu

Field	Description
Codec Proposal Sequence	<p>Choose the order in which the codecs are offered for use by the media gateway. If the first codec cannot be used, the second is tried and so on.</p> <p>Possible values:</p> <ul style="list-style-type: none"> • <i>Standard</i> (default value): the codec in the first position in the menu shown will be used if possible. • <i>Quality</i>: the codecs are sorted by quality. If possible, the codec with the best quality is used. • <i>Lowest</i>: the codecs are sorted by required bandwidth. If possible, the codec with the lowest bandwidth requirement is used. • <i>Highest</i>: the codecs are sorted by required bandwidth. If possible, the codec with the highest bandwidth requirement is used.
Sort Order	<p>Shows the codecs in the order in which the system will attempt to use them depending on the setting in the Codec Proposal Sequence field. The first codec in the sequence is always used if possible.</p> <p>By default, all codecs shown are enabled. You can disable codecs.</p>

Fields in the Advanced Settings Voice Quality Settings menu

Field	Description
Echo Cancellation	<p>Select whether echo cancellation should be used.</p> <p>Echo cancellation is a technique to suppress echo feedback in voice communication on full duplex lines.</p> <p>The function is activated with <i>Enabled</i>.</p> <p>The function is enabled by default.</p>
Comfort Noise Generation	<p>Specify whether Comfort Noise Generation should be used.</p> <p>For digital voice transmission, Comfort Noise Generation introduces a low level of background noise to avoid the impression that, during pauses at the other end, the connection is lost.</p> <p>The function is activated with <i>Enabled</i>.</p> <p>The function is enabled by default.</p>
Packet Size	<p>Enter the transmission time of an RTP data packet in milliseconds.</p> <p>Possible values are <i>10</i> to <i>210</i>.</p> <p>The default value is <i>30</i>.</p>

13.2.2 SIP Accounts

In the **VoIP** -> **Media Gateway** -> **SIP Accounts** menu, a list of all existing SIP accounts is shown.

13.2.2.1 Edit/New

Choose the  icon to edit existing entries. Select the **New** button to create new SIP accounts.

bintec R1200 Language English Online Help Logout **funkwerk**

Save configuration

System Management
Physical Interfaces
LAN
Wireless LAN
Routing
WAN
VPN
Firewall
VoIP
Application Level Gateway
Media Gateway
Local Services
Maintenance
External Reporting
Monitoring

Extensions SIP Accounts Call Routing CLID Translation Call Translation Options

Basic Parameters

Description

Administrative Status Enabled

Trunk Mode Off Client Server

Registrar

Outbound Proxy

Realm

Protocol UDP Port: 5060

User Name

Authentication ID

Password

Registration Enabled

Expire Time 600 sec

Advanced Settings

Codec Settings

Codec Proposal Sequence Default Quality Low Bandwidth High Bandwidth

Sort Order G.711 uLaw G.711 aLaw G.729 G.726-40
 G.726-32 G.726-24 G.726-16 DTMF Outband

Voice Quality Settings

Echo Cancellation Enabled

Comfort Noise Generation Enabled

Packet Size 20 ms

OK Cancel

Fig. 159: VoIP -> Media Gateway -> SIP Accounts -> Edit/New

The VoIP ->Media Gateway ->SIP Accounts-> Edit/New menu consists of the following fields:

Fields in the SIP Accounts Basic Parameters menu

Field	Description
Description	Enter the name of the account.
Administrative Status	Select whether the administrative status of the account should be enabled or disabled. The function is activated with <i>Enabled</i> . The function is enabled by default.

Field	Description
Trunk Mode	<p>Select the trunk mode to be used.</p> <p>Possible values:</p> <ul style="list-style-type: none"> • <i>Off</i> (default value) The trunk mode is not used. • <i>Client</i>: the media gateway is operated as SIP client. • <i>Server</i>: the media gateway is operated as SIP server.
Registrar	<p>Only for Trunk Mode = <i>Off</i> or Trunk Mode = <i>Client</i>.</p> <p>Enter the IP address or domain name (FQDN) of the SIP registrar or the SIP proxy server. The maximum number of characters is 40.</p>
Outbound Proxy	<p>Only for Trunk Mode = <i>Server</i>.</p> <p>Enter the name or IP address of the SIP outbound proxy server.</p> <p>A maximum of 32 characters can be entered.</p> <p>Here you must enter a name only if, for all SIP sessions, the communication is not to be direct but via a further proxy.</p> <p>Enter a name or IP address only if this is explicitly specified by the provider.</p>
Realm	<p>Enter a new domain name or a new IP address for the SIP proxy server.</p> <p>If you do not enter a domain name, the name in the Registrar field is used.</p> <p>Enter a name only if this is explicitly specified by the provider.</p>
Protocol	<p>Select the protocol to be used for data transport.</p> <p>Possible values: <i>udp</i> (default value) or <i>tcp</i>.</p> <p>Enter the Port via which the data is to be transported.</p> <p>The ports can be provider-specific.</p> <p>The default value is <i>5060</i>.</p>
User Name	<p>Enter the username for authentication if your VoIP provider has</p>

Field	Description
	assigned one for you.
Authentication ID	<p>Enter a name that is to be used for authentication.</p> <p>If you do not enter a name, the name in the User Name field is used.</p> <p>Enter a name only if this is explicitly specified by the provider.</p>
Password	<p>The VoIP provider gives you a password for authentication. You must enter this value here.</p> <p>A maximum of 40 characters can be entered.</p>
Registration	<p>Specify whether the registration mechanism is to be used by SIP REGISTER. Normally, every SIP client (user) sends its current position to a REGISTRAR server by means of a REGISTER message. This information about the user and his current address is held by the REGISTRAR server and queried by other proxies to find the user.</p> <p>The function is activated with <i>Enabled</i>.</p> <p>The function is enabled by default.</p>
Expire Time	<p>Only if Registration is enabled.</p> <p>Enter the time in seconds after which the current registration becomes invalid and a new registration request is therefore sent.</p> <p>Possible values are 0 to 99999.</p> <p>The default value is 600.</p> <p>In answer to a REGISTER request, a server can set another Expire Time which overwrites the setting here.</p>

Fields in the SIP Accounts Trunk Settings menu

Field	Description
SIP Header Field(s) for Caller Address	<p>Only for Trunk Mode = <i>Client</i> or Trunk Mode = <i>Server</i>.</p> <p>Specify where and how the DDI sender (caller) address is sent for outgoing calls. (For incoming calls, the subscriber number is sought automatically.)</p>

Field	Description
	<p>Possible values:</p> <ul style="list-style-type: none"> • <i>Disabled</i> (default value): the DDI sender address is not sent. • <i>Display and User Name</i>: the sender address is placed in both "Display" and "User" fields of the SIP header. • <i>Display only</i>: the sender address is placed in the "Display" field of the SIP header. • <i>User only</i>: the sender address is placed in the "User" field of the SIP header. • <i>P-Preferred</i>: The so-called "p-preferred-identity" field is added to the SIP header and contains the sender address. • <i>P-Asserted</i>: The so-called "p-asserted-identity" field is added to the SIP header and contains the sender address.
Extension	<p>Only for Trunk Mode = <i>Server</i>.</p> <p>You can set a number that is added as a prefix for outgoing calls and is removed from the sender address for incoming calls. This corresponds to the trunk (exchange) number of an exchange.</p>

Fields in the Advanced Settings Codec Settings menu

Field	Description
Codec Proposal Sequence	<p>Choose the order in which the codecs are offered for use by the media gateway. If the first codec cannot be used, the second is tried and so on.</p> <p>Possible values:</p> <ul style="list-style-type: none"> • <i>Standard</i> (default value): the codec in the first position in the menu shown will be used if possible. • <i>Quality</i>: the codecs are sorted by quality. If possible, the codec with the best quality is used. • <i>Low Bandwidth</i>: the codecs are sorted by required bandwidth. If possible, the codec with the lowest bandwidth requirement is used. • <i>High Bandwidth</i>: the codecs are sorted by required bandwidth. If possible, the codec with the highest bandwidth requirement is used.

Field	Description
Sort Order	<p>Select the codecs to be proposed for the connection. The codecs chosen here are proposed in a certain order depending on the setting in the Codec Proposal Sequence field.</p> <p>Possible values:</p> <ul style="list-style-type: none"> • <i>G.711 uLaw</i>: ISDN codec with US law • <i>G.711 aLaw</i>: ISDN codec with EU law • <i>G0.729</i>: Compressed from 31 to 8 kbps; good voice quality • <i>G.726-40</i>: Compressed from 63 to 40 kbps • <i>G.726-32</i>: Compressed from 55 to 32 kbps • <i>G.726-24</i>: Compressed from 47 to 24 kbps • <i>G.726-16</i>: Compressed from 39 to 16 kbps • <i>DTMF outb.</i>: DTMF Outband. First the system attempts to use RFC 2833. If the remote terminal does not use this standard, SIP Info is used. <p><i>G.711 uLaw</i>, <i>G.711 aLaw</i> and <i>G.729</i> are enabled by default.</p>

Fields in the Advanced Settings Voice Quality Settings menu

Field	Description
Echo cancellation	<p>Select whether echo cancellation should be used.</p> <p>Echo cancellation is a technique to suppress echo feedback in voice communication on full duplex lines.</p> <p>The function is activated with <i>Enabled</i>.</p> <p>The function is enabled by default.</p>
Comfort Noise Generation	<p>Specify whether Comfort Noise Generation should be used.</p> <p>For digital voice transmission, Comfort Noise Generation introduces a low level of background noise to avoid the impression that, during pauses at the other end, the connection is lost.</p> <p>The function is activated with <i>Enabled</i>.</p> <p>The function is enabled by default.</p>
Packet Size	Enter the transmission time of an RTP data packet in milli-

Field	Description
	seconds.
	Possible values are 10 to 210.
	The default value is 20.

13.2.3 Call Routing

Here you can define the conditions for the routing of calls.

In the **VoIP -> Media Gateway -> Call Routing** menu, a list of all existing entries is shown.

13.2.3.1 Edit/New

Choose the  icon to edit existing entries. Select the **New** button to create new entries.

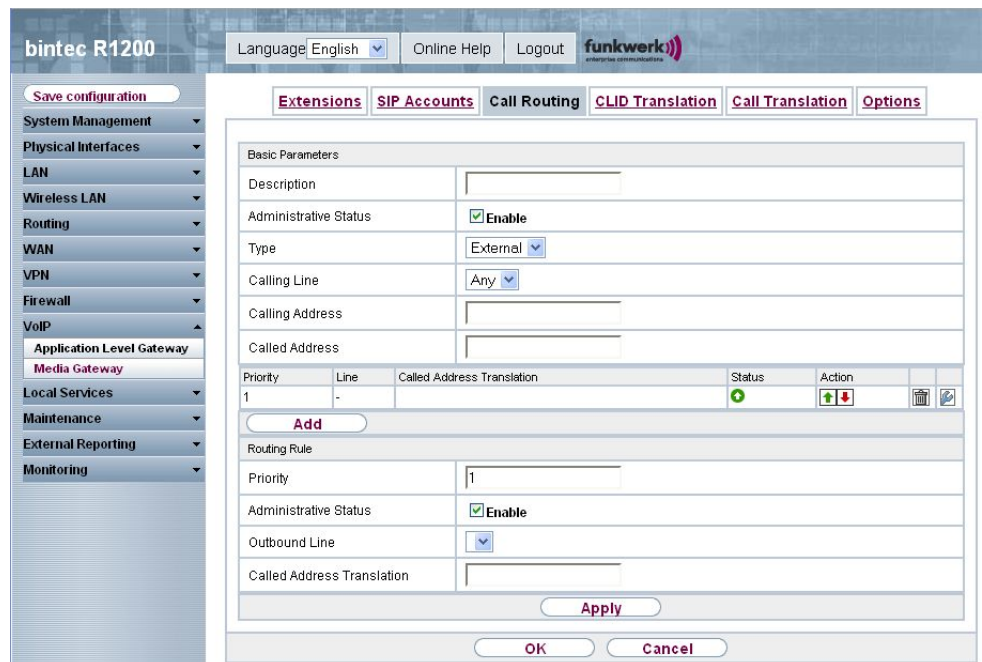

The screenshot shows the web interface for configuring Call Routing. The left sidebar contains a navigation menu with categories like System Management, Physical Interfaces, LAN, Wireless LAN, Routing, WAN, VPN, Firewall, VoIP, Application Level Gateway, Media Gateway, Local Services, Maintenance, External Reporting, and Monitoring. The main content area is titled 'bintec R1200' and includes a language dropdown (English), online help, and logout options. The 'Call Routing' tab is selected, showing a configuration form with the following fields:

- Basic Parameters:**
 - Description: [Text Field]
 - Administrative Status: Enable
 - Type: External (Dropdown)
 - Calling Line: Any (Dropdown)
 - Calling Address: [Text Field]
 - Called Address: [Text Field]
- Table:**

Priority	Line	Called Address Translation	Status	Action
1	-			
- Routing Rule:**
 - Priority: 1 (Text Field)
 - Administrative Status: Enable
 - Outbound Line: [Dropdown]
 - Called Address Translation: [Text Field]

Buttons for 'Add', 'Apply', 'OK', and 'Cancel' are located at the bottom of the configuration area.

Fig. 160: VoIP -> Media Gateway -> Call Routing->Edit/New

The **VoIP ->Media Gateway ->Call Routing-> Edit/New** menu consists of the following fields:

Fields in the Call Routing Basic Parameters menu

Field	Description
Description	Enter the name of the call routing entry.
Administrative Status	<p>Select whether the call routing entry should be enabled or disabled.</p> <p>The function is activated with <i>Enabled</i>.</p> <p>The function is enabled by default.</p>
Type	<p>Specify how calls are to be routed.</p> <p>Possible values:</p> <ul style="list-style-type: none"> • <i>External</i> (default value): For calls that are to be routed as outgoing, external calls. This can be done using standard SIP accounts or SIP trunking accounts in DDI client mode. • <i>Trunk</i>: for calls to be routed to a PBX behind the Media Gateway that is connected by a PSTN line. For this, the following can be used: PRI interfaces in NT mode, BRI interfaces in NT mode, FXS interfaces, SIP trunking accounts in DDI server mode. • <i>Deny</i>: For calls that are not to be routed (to be blocked).
Calling Line	<p>You can restrict the routing entry to the line on which the call comes in.</p> <p>The selection depends on the interfaces available and on the SIP accounts that have been created.</p> <p>Possible values:</p> <ul style="list-style-type: none"> • <i>PRI</i>: restricts the routing entry to the selected PRI interface. • <i>BRI</i>: restricts the routing entry to the selected BRI interface. • <i>FXO</i>: restricts the routing entry to the selected FXO interface. • <i><SIP Account></i>: restricts the routing entry to the selected SIP account. • <i>Any</i>: no restriction of the routing entry.
Calling Address	You can restrict the routing entry to a particular caller. To do this, you must specify the subscriber number exactly (no wild-cards).

Field	Description
Called Address	<p>You can enter an address numerically (e.g. a subscriber number) or alphanumerically (e.g. for a trunk) that is to be compared with a dialled address.</p> <p>The following wildcards can be used:</p> <ul style="list-style-type: none"> • * means that at the end of a character string an arbitrary number of any characters can follow, • ? is a placeholder for an arbitrary character. <p>If the configured address agrees with the signalled address, the routing entry is used.</p>

Add and configure routing entries under **Routing Rules**. You can also delete routing entries.

Use **Add** to create entries.

Fields in the Call Routing Routing Rules menu (only if Type is not Deny)

Field	Description
Priority	<p>Enter a whole number starting with 1 in ascending order to define the order of filter rules.</p> <p>The rules are worked through in the order given in the list.</p> <p>If a line or SIP account is not available, the next rule is automatically used.</p>
Administrative Status	<p>Select whether the filter rule should be activated.</p> <p>The rule is activated with <i>Enabled</i>.</p> <p>The rule is active by default.</p>
Outbound Line	<p>Choose the PSTN line (PRI, BRI, FXO) used for the outgoing call.</p>
Trunk Line	<p>Only for Type = <i>Trunk</i>.</p> <p>Choose the PSTN SIP account used for the outgoing call.</p>
Called Address Translation	<p>Enter how the subscriber number is manipulated before it is used for dialling.</p>

Field	Description
	<p>Notation: <a:b>, i.e. a is replaced by b. A number of rules can be chained together using semicolons as separators, e.g. <a:b>;<c:d>;<e:f>. After confirmation of entry, the rule chain is automatically sorted by the "best match" method.</p> <p>Numerical and alphanumerical values are permissible.</p> <p>? is a placeholder for an arbitrary character.</p> <hr/> <p>Example 13.1. Example of a rule</p> <ul style="list-style-type: none"> • rule: <:+49911> • number dialled: 96731234 • manipulated number: +4991196731234

13.2.4 CLID Translation

Here you define the processing of the calling party number for incoming calls. You can, for example, add a prefix to a received call number in order to route corresponding outgoing calls via a particular account.

In the **VoIP -> Media Gateway ->CLID Translation** menu, a list of all existing entries is shown on which the received number is edited.

13.2.4.1 Edit/New

Choose the  icon to edit existing entries. Select the **New** button to create entries for CLID translation.

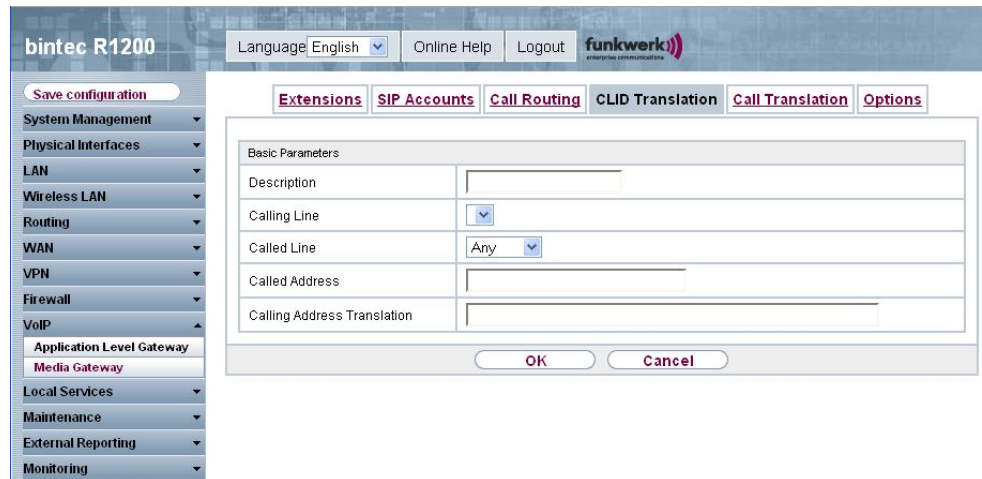

Fig. 161: VoIP -> Media Gateway -> CLID Translation ->Edit/New

The VoIP ->Media Gateway -> CLID Translation-> Edit/New menu consists of the following fields:

Fields in the CLID Translation Basic Parameters menu

Field	Description
Description	Enter the name of the CLID translation entry.
Calling Line	<p>Select the PSTN line or SIP account from which the call comes.</p> <p>The selection depends on the interfaces available and on the SIP accounts that have been created.</p> <p>Possible values:</p> <ul style="list-style-type: none"> • <i>PRI</i>: Restricts the entry to the selected PRI interface. • <i>BRI</i>: Restricts the entry to the selected BRI interface. • <i>FXO</i>: Restricts the entry to the selected FXO interface. • <i><SIP Account></i>: Restricts the entry to the selected SIP account. • <i>ALL</i>: No restriction of the entry.
Called Line	<p>Here you have the option of entering the destination line of the call.</p> <p>Possible values:</p> <ul style="list-style-type: none"> • <i>PRI</i>: Restricts the entry to the selected PRI interface.

Field	Description
	<ul style="list-style-type: none"> • <i>BRI</i>: Restricts the entry to the selected BRI interface. • <i>FXO</i>: Restricts the entry to the selected FXO interface. • <i><SIP Account></i>: Restricts the entry to the selected SIP account. • <i>Any</i>: No restriction of the entry. <p>Enter Called Line or Called Address.</p> <p>If a value other than <i>Any</i> is chosen, the Called Address should not be used. If you set Called Line = <i>Any</i> and Called Address is not used, all calls on the Calling Line are processed.</p>
Called Address	<p>Here you have the option of entering the destination address of the call.</p> <p>Enter Called Line or Called Address. If the Called Address is used, Called Line = <i>Any</i> should be set.</p>
Calling Address Translation	<p>Enter the transformation rule applied to the call numbers.</p> <p>Notation: <a:b>, i.e. a is replaced by b. A number of rules can be chained together using semicolons as separators, e.g. <a:b>;<c:d>;<e:f>. After confirmation of entry, the rule chain is automatically sorted by the "best match" method.</p> <p>? is a placeholder for an arbitrary digit.</p> <hr/> <p>Example 13.2. Example of a rule</p> <ul style="list-style-type: none"> • rule: <:+49911> • number dialled: 96731234 • manipulated number: +4991196731234

13.2.5 Call Translation

You can create a list for the translation of subscriber numbers, i.e. this list associates internal and external numbers.



Note

Which number (called party number or calling party number) is translated depends on the direction (incoming or outgoing) of the call in question. For incoming calls it is the called party number, for outgoing calls the calling party number that is translated.

For example, the internal number 340 can be shown externally as 09119673900 or a call from outside for the number 09119673200 can be routed internally to the number 340.

In the **VoIP -> Media Gateway -> Call Translation** menu, a list of all existing entries is shown on which the received number is edited.

13.2.5.1 Edit/New

Choose the  icon to edit existing entries. Select the **New** button to create entries for call translation.

Fig. 162: VoIP -> Media Gateway -> Call Translation ->Edit/New

The **VoIP ->Media Gateway ->Call Translation-> Edit/New** menu consists of the following fields:

Fields in the Call Translation Basic Parameters menu

Field	Description
Description	Enter the name of the call translation.
Direction	Select the direction for the entry.

Field	Description
	<p>Possible values:</p> <ul style="list-style-type: none"> • <i>Both</i> (default value): For incoming and outgoing calls (bidirectional). • <i>Incoming</i>: For incoming calls. • <i>Outgoing</i>: For outgoing calls.
Associated Line	<p>Select the line or SIP account via which the calls are to be routed.</p> <p>Possible values:</p> <ul style="list-style-type: none"> • <i>PRI</i>: Restricts the call to the selected PRI interface. • <i>BRI</i>: Restricts the call to the selected BRI interface. • <i>FXO</i>: Restricts the call to the selected FXO interface. • <i>FXS</i>: Restricts the call to the selected FXS interface. • <i><SIP Account></i>: Restricts the call to the selected SIP account.
Local Address	<p>Enter the internal number (e.g. extension or PABX number). For incoming calls, the signalled Called Party Number (corresponds in the menu to the External Address field) is translated to the Local Address. For outgoing calls, the signalled Calling Party Number (corresponds in the menu to the Local Address field) is translated to the External Address.</p> <p>Numerical and alphanumerical characters are permissible.</p> <p>? is a placeholder for an arbitrary digit.</p> <p>Note Local Address and External Address must contain the same number of wildcards.</p>
External Address	<p>The External Address is not shown if the field Associated Line = <i><SIP Account></i>.</p> <p>Enter the external number (e.g. ISDN MSN or SIP account subscriber number). For incoming calls, the signalled Called Party Number (corresponds in the menu to the External Address field) is translated to the Local Address. For outgoing calls, the signalled Calling Party Number (corresponds in the menu to the Local Address field) is translated to the External Address.</p>

13.2.6 Options

In the **VoIP -> Media Gateway -> Options** menu, you can make global settings for the media gateway.

Fig. 163: **VoIP -> Media Gateway -> Options**

The **VoIP ->Media Gateway -> Options** menu consists of the following fields:

Fields in the Options Basic Parameters menu

Field	Description
Session Border Controller Mode	<p>Specify how the media gateway should behave in conjunction with a session border controller mode.</p> <p>Possible values:</p> <ul style="list-style-type: none"> • <i>OFF</i>: Call routing is handled exclusively by the media gateway in accordance with the configured call routing and the local extensions. For calls that are to be routed via a particular provider (account), you must configure a corresponding call routing entry. Internal calls (from internal extension to internal extension) that are only to be routed internally do not require an additional call routing entry. • <i>Auto</i>: For all extensions that exactly agree with an existing account, the call routing is handled by the session border controller, i.e. all SIP messages configured for the corresponding account are forwarded to the session border controller. For all

Field	Description
	<p>other extensions, the call routing is handled by the media gateway in accordance with the configured call routing entries. Note that the call routing is handled by the media gateway if the provider is not available (backup).</p> <ul style="list-style-type: none"> • <i><SIP Trunk></i>: A SIP trunk account is configured and selected for the session border controller under VoIP -> Media Gateway -> SIP Accounts. In this case, the call routing for all extensions is handled by the session border controller, all SIP messages configured for the selected account are forwarded to the session border controller. Note that the call routing is handled by the media gateway if the provider is not available (backup).
Media Stream Termination	<p>Choose how RTP sessions are controlled by the system.</p> <p>The function is activated with <i>Enabled</i>.</p> <p>The function is enabled by default.</p> <p>If the function is enabled, RTP sessions are terminated on the media gateway, i.e. all RTP streams are controlled by the media gateway and routed via the media gateway. The participating terminal devices (e.g. SIP telephones) are not connected directly with one another. Note that, for VoIP to VoIP connections, there is no code translation for different VoIP terminal codecs. The codecs of media gateway and VoIP terminals must therefore agree.</p> <p>If the function is disabled, RTP sessions are not terminated on the media gateway, i.e. all RTP streams are routed by the media gateway without termination. The RTP data packets can be routed in complex networks and thus also via other gateways.</p>
Default Drop Extension	<p>You can nominate an extension to receive calls that cannot be routed because there is no valid routing entry for them.</p>
Dial Latency	<p>Enter the maximum delay time before the system assumes the call number entered is complete and starts the SIP dialling process (sends the SIP INVITE message). This timeout is reset each time that a button is pressed.</p> <p>The default value is 5.</p> <p>If you terminate the number entered with #, dialling is immedi-</p>

Field	Description
	ate.

Fields in the Advanced Settings menu

Field	Description
Speed Dialing	Click Add to configure new speeddial numbers.

Chapter 14 Local services

14.1 DNS

Each device in a TCP/IP network is usually located by its IP address. Because host names are often used in networks to reach different devices, it is necessary for the associated IP address to be known. This task can be performed by a DNS server, which resolves the host names into IP addresses. Alternatively, name resolution can also take place over the HOSTS file, which is available on all PCs.

Your device offers the following options for name resolution:

- DNS Proxy, for forwarding DNS requests sent to your device to a suitable DNS server. This also includes specific forwarding of defined domains (Forwarded Domains).
- DNS cache, for saving the positive and negative results of DNS requests.
- Static entries (Static Hosts), for manually defining or preventing assignments of IP addresses to names.
- DNS monitoring, for providing an overview of DNS requests on your device.

Global Name Server

The IP addresses of global name servers that are queried if your device is unable to answer requests itself or by forwarding entries are entered in **Local Services -> DNS -> Global Settings -> Basic Parameters**.

For local applications, the IP address of your device or the general loopback address (127.0.0.1) can be entered as the global name server.

Your device can also receive the global name servers dynamically and transfer them dynamically if necessary.

Strategy for name resolution on your device

A DNS request is handled by your device as follows:

- (1) If possible, the request is answered directly from the static or dynamic cache with IP address or negative response.
- (2) Otherwise, if a suitable forwarding entry exists, the relevant DNS server is asked, depending on the configuration of the Internet or dialin connections, if necessary by setting up a WAN connection at extra cost. If the DNS server can resolve the name, the

information is forwarded and a dynamic entry created in the cache.

- (3) Otherwise, if global name servers are entered, the primary DNS server then the secondary DNS server are asked. If the IP address of your device or the loopback address is entered for local applications, these are ignored here. If one of the DNS servers can resolve the name, the information is forwarded and a dynamic entry created in the cache.
- (4) Otherwise, if a suitable Internet or dialin connection is selected as the standard interface, the relevant DNS server is asked, depending on the configuration of the Internet or dialin connections, if necessary by setting up a WAN connection at extra cost. If one of the DNS servers can resolve the name, the information is forwarded and a dynamic entry created in the cache.
- (5) Otherwise, if overwriting the addresses of the global name servers is allowed (**DNS Server Configuration** = *Dynamic*), a connection is set up – in some cases at extra cost – that is configured to enable DNS server addresses to be requested from DNS servers (**DNS Negotiation** = *Enabled*), if this has not been attempted previously. If name server negotiation is successful, these are entered as global name servers and are therefore available for further requests.
- (6) Otherwise the initial request is answered with a server error.

If one of the DNS servers answers with `non-existent domain`, the initial request is immediately answered accordingly and a corresponding negative entry is made in the DNS cache of your device.

14.1.1 Global Settings

The screenshot shows the web interface for a bintec R1200 device. The top bar includes 'Language English', 'Online Help', 'Logout', and the 'funkwerk' logo. The left navigation menu lists various system management options, with 'Local Services' expanded to show 'DNS'. The main content area has tabs for 'Global Settings', 'Static Hosts', 'Domain Forwarding', 'Cache', and 'Statistics'. The 'Global Settings' tab is selected, displaying the following configuration fields:

Basic Parameters

- Domain Name: [Text Input]
- DNS Server Configuration: Dynamic Static
- WINS Server:
 - Primary: [0.0.0.0]
 - Secondary: [0.0.0.0]

Advanced Settings:

- Positive Cache: Enabled
- Negative Cache: Enabled
- Cache Size: [100]
- Maximum TTL for Positive Cache Entries: [86400]
- Maximum TTL for Negative Cache Entries: [86400]
- Fallback interface to get DNS server: [Automatic]
- IP address to use for DNS/WINS server assignment:
 - As DHCP Server: None Setting Own IP Address Global DNS
 - As IPCP Server: None Setting Own IP Address Global DNS

Buttons for 'OK' and 'Cancel' are located at the bottom of the form.

Fig. 164: Local Services -> DNS -> Global Settings

The menu **Lokale Dienste -> DNS -> Global Settings** consists of the following fields:

Fields in the Global Settings Basic Parameters menu

Field	Description
Domain Name	Enter the standard domain name of your device.
DNS Server Configuration	<p>Select whether the addresses of the global name server on your device can be overwritten by transferred name server addresses.</p> <p>Possible values:</p> <ul style="list-style-type: none"> <i>Dynamic</i> (default value) The name server addresses can be automatically overwritten. <i>Static</i>: The name server addresses are not overwritten.

Field	Description
DNS Server	Only for DNS Server Configuration = <i>Static</i>
Primary	Enter the IP address of the first and, if necessary, second global DNS server.
Secondary	
WINS Server	Enter the IP address of the first and, if necessary, alternative global Windows Internet Name Server (=WINS) or NetBIOS Name Server (=NBNS).
Primary	
Secondary	

The **Advanced Settings** menu consists of the following fields:

Fields in the Advanced Settings menu

Field	Description
Positive Cache	<p>Select whether the positive dynamic cache is to be activated, i.e. successfully resolved names and IP addresses are to be stored in the cache.</p> <p>The function is activated by choosing <i>Enabled</i>.</p> <p>The function is enabled by default.</p>
Negative Cache	<p>Select whether the negative dynamic cache is to be activated, i.e. whether queried names for which a DNS server has sent a negative response are stored as negative entries in the cache.</p> <p>The function is activated by choosing <i>Enabled</i>.</p> <p>The function is enabled by default.</p>
Cache Size	<p>Enter the maximum total number of static and dynamic entries.</p> <p>Once this value is reached, the dynamic entry not requested for the longest period of time is deleted when a new entry is added. If the Cache Size is reduced by the user, dynamic entries are deleted if necessary. Static entries are not deleted. Cache Size cannot be set to smaller than the current number of static entries.</p> <p>Possible values: <i>0 .. 1000</i> .</p> <p>The default value is <i>100</i>.</p>

Field	Description
Maximum TTL for Positive Cache Entries	<p>Enter the value to which the TTL is to be set for a positive dynamic DNS entry in the cache if its TTL is 0 or its TTL exceeds the value for Maximum TTL for Positive Cache Entries.</p> <p>The default value is <i>86400</i>.</p>
Maximum TTL for Negative Cache Entries	<p>Enter the value set to which the TTL is to be set in the case of a negative dynamic entry in the cache.</p> <p>The default value is <i>86400</i>.</p>
Fallback Interface to get DNS Servers	<p>Select the interface to which a connection is set up for name server negotiation if other name resolution attempts were not successful.</p> <p>The default value is <i>Automatic</i> i.e. a one-time connection is set up to the first suitable connection partner configured in the system.</p>
IP Address to use for DNS/WINS Server Assignment	<p>As DHCP Server</p> <p>Select which name server addresses are sent to the DHCP client if your device is used as DHCP server.</p> <p>Possible values:</p> <ul style="list-style-type: none"> • <i>None</i>: No name server address is sent. • <i>Own IP Address</i> (default value): The address of your device is transferred as the name server address. • <i>Global DNS Setting</i>: The addresses of the global name servers entered on your device are sent. <p>As IPCP Server</p> <p>Select which name server addresses are to be transmitted by your device in the event of dynamic server name negotiation if your device is used as the IPCP server for PPP connections.</p> <p>Possible values:</p> <ul style="list-style-type: none"> • <i>None</i>: No name server address is sent. • <i>Own IP address</i>: The address of your device is transferred as the name server address. • <i>Global DNS Setting</i> (default value): The addresses of the

Field	Description
	global name servers entered on your device are sent.

14.1.2 Static Hosts

In the **Local Services -> DNS -> Static Hosts** menu, a list of all configured static hosts is shown.

14.1.2.1 New

Choose the **New** button to set up new static hosts.

The screenshot shows the web interface for a bintec R1200 device. The top navigation bar includes 'Language English', 'Online Help', 'Logout', and the 'funkwerk' logo. The left sidebar menu is expanded to 'Local Services', with 'Static Hosts' selected. The main content area displays the 'Static Hosts' configuration page, which has tabs for 'Global Settings', 'Static Hosts', 'Domain Forwarding', 'Cache', and 'Statistics'. The 'Basic Parameters' section contains the following fields:

- Description: [Empty text box]
- Response: [Positive (dropdown menu)]
- IP Address: [0.0.0.0]
- TTL: [86400] Seconds

At the bottom of the form are 'OK' and 'Cancel' buttons.

Fig. 165: Local Services -> DNS ->Static Hosts -> New

The **Local Services -> DNS -> Static Hosts-> New** menu consists of the following fields:

Fields in the Static Hosts Basic Parameters menu

Field	Description
Description	Enter the host name to which the IP Address defined in this menu is to be assigned if a positive response is received to a DNS request. If a negative response is received to a DNS request, no address is specified.

Field	Description
	<p>The entry can also start with the wildcard *, e.g. *.funkwerk.de.</p> <p>If a name is entered without a dot, this is completed with <Name>. after confirming with OK " is added.</p>
Response	<p>In this entry, select the type of response to DNS requests.</p> <p>Possible values:</p> <ul style="list-style-type: none"> • <i>Negative</i> : A DNS request for Name is answered with a negative response. • <i>Positive</i> (default value): A DNS request for Name is answered with the associated IP address. • <i>None</i>: A DNS request is ignored; no answer is given.
IP Address	<p>Only if Response = <i>Positive</i>.</p> <p>Enter the IP address assigned to Name.</p>
TTL	<p>Enter the the time for which the assignment of Name to IP Address is to be valid in seconds (only relevant if Response = <i>Positive</i>) that is transferred to requesting hosts.</p> <p>The default value is <i>86400</i> (= 24 h).</p>

14.1.3 Domain Forwarding

In the **Local Services** -> **DNS** -> **Domain Forwarding** menu, a list of all configured forwarding for defined domains is shown.

14.1.3.1 New

Choose the **New** button to set up new forwardings.

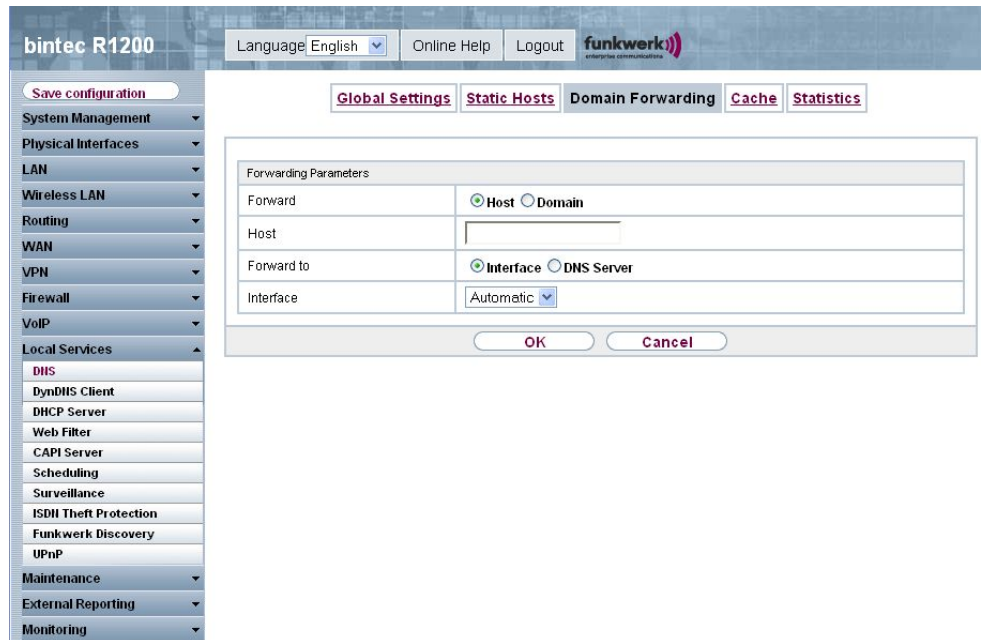

Fig. 166: Local Services -> DNS ->Domain Forwarding -> New

The **Local Services -> DNS ->Domain Forwarding -> New** menu consists of the following fields:

Fields in the Domain Forwarding Forwarding Parameters menu

Field	Description
Forwarding	Select whether a host or domain is to be forwarded. Possible values: <ul style="list-style-type: none"> • <i>Host</i> (default value) • <i>Domain</i>
Host	Only for Forward = <i>Host</i> Enter the name of the host to be forwarded. The entry can also start with the wildcard *, e.g. *.funkwerk.com. If a name is entered without a full stop, once you confirm with OK " <Default Domain>." is added.
Domain	Only for Forward = <i>Domain</i> Enter the name of the domain to be forwarded.

Field	Description
	The entry can also start with the wildcard *, e.g. *.funkwerk.com. If a name is entered without a full stop, once you confirm with OK " <Default Domain>." is added.
Forward to	Select the forwarding destination requests to the name defined in Host or Domain . Possible values: <ul style="list-style-type: none"> • <i>Interface</i> (default setting) The request is forwarded to the defined Interface. • <i>DNS Server</i>: The request is forwarded to the defined DNS server.
Interface	Only for Forward to = <i>Interface</i> Select the interface via which the requests for the defined Domain are to be received and forwarded to the DNS server.
DNS Server	Only for Forward to = <i>DNS server</i> Enter the IP address of the primary and secondary DNS server.

14.1.4 Cache

In the **Local Services** -> **DNS** -> **Cache** menu, a list of all available cache entries is shown.

The screenshot shows the web interface for a bintec R1200 device. The top navigation bar includes 'Language English', 'Online Help', 'Logout', and the 'funkwerk' logo. The left sidebar contains a tree view of system management options, with 'Local Services' expanded to show 'DNS' selected. The main content area displays the 'Cache' configuration page, which includes a table of DNS entries. The table has columns for 'Description', 'IP Address', 'Response', 'TTL', 'Reference Counter', and actions: 'Select all / Deselect all' and 'Make static'. The table is currently empty, and the page number is 1. There are 'OK' and 'Cancel' buttons at the bottom of the table area.

Fig. 167: Local Services -> DNS ->Cache

You can select individual entries using the checkbox in the corresponding line, or select them all using the **Select All** button.

A dynamic entry can be converted to a static entry by marking the entry and confirming with **Set to Static**. This entry then disappears from the list and is included in the list in the **Static Hosts** menu. The TTL is transferred in this operation.

14.1.5 Statistics

The screenshot shows the web interface for a bintec R1200 device. The top navigation bar includes 'Language English', 'Online Help', 'Logout', and the 'funkwerk' logo. The left sidebar contains a menu with categories like 'System Management', 'Physical Interfaces', 'LAN', 'Wireless LAN', 'Routing', 'WAN', 'VPN', 'Firewall', 'VoIP', 'Local Services', 'Maintenance', 'External Reporting', and 'Monitoring'. The 'Local Services' menu is expanded, showing 'DNS', 'DynDNS Client', 'DHCP Server', 'Web Filter', 'CAPI Server', 'Scheduling', 'Surveillance', 'ISDN Theft Protection', 'Funkwerk Discovery', and 'UPnP'. The main content area has tabs for 'Global Settings', 'Static Hosts', 'Domain Forwarding', 'Cache', and 'Statistics'. The 'Statistics' tab is active, displaying a table of DNS statistics. Above the table, there is an 'Automatic Refresh Interval' set to 60 seconds and an 'Apply' button.

DNS Statistics	
Received DNS Packets	0
Invalid DNS Packets	0
DNS Requests	0
Cache Hits	0
Forwarded Requests	0
Cache Hitrate (%)	0
Successfully Answered Queries	0
Server Failures	0

Fig. 168: Local Services -> DNS -> Statistics

In the menu **Lokale Dienste** -> **DNS** -> **Statistics**, the following statistical values are shown:

Fields in the Statistics DNS Statistics menu

Field	Description
Received DNS Packets	Shows the number of received DNS packets addressed direct to your device, including the response packets for forwarded requests.
Invalid DNS Packets	Shows the number of invalid DNS packets received and addressed direct to your device.
DNS Requests	Shows the number of valid DNS requests received and addressed direct to your device.
Cache Hits	Shows the number of requests that were answered with static or dynamic entries from the cache.
Forwarded Requests	Shows the number of requests forwarded to other name servers.
Cache Hitrate (%)	Displays the number of Cache Hits per DNS Request in %.

Field	Description
Successfully Answered Queries	Shows the number of successfully answered requests (positive and negative).
Server Failures	Shows the number of requests that were not answered by any name server (either positively or negatively).

14.2 DynDNS Client

The use of dynamic IP addresses has the disadvantage that a host in the network can no longer be found once its IP address has changed. DynDNS ensures that your device can still be reached after a change to the IP address.

The following configuration steps are necessary:

- Registration of a host name at a DynDNS provider
- Configuration of your device

Enrolment

The registration of a host name means that you define an individual user name for the DynDNS service, e.g. *dyn_client*. The service providers offer various domain names for this, so that a unique host name results for your device, e.g. *dyn_client.provider.com*. The DynDNS provider relieves you of the task of answering all DNS requests concerning the host *dyn_client.provider.com* with the dynamic IP address of your device.

To ensure that the provider always knows the current IP address of your device, your device contacts the provider when setting up a new connection and propagates its present IP address.

14.2.1 DynDNS Update

In the **Local Services** -> **DynDNS Client** -> **DynDNS Update** menu, a list of all configured DynDNS registrations is shown that are to be updated.

14.2.1.1 New

Choose the **New** button to set up further DynDNS registrations to be updated.

The screenshot shows the configuration interface for a DynDNS client on a bintec R1200 device. The left sidebar contains a menu with categories like System Management, Physical Interfaces, LAN, Wireless LAN, Routing, WAN, VPN, Firewall, VoIP, Local Services, Maintenance, External Reporting, and Monitoring. Under 'Local Services', 'DynDNS Client' is selected, leading to the 'DynDNS Update' page. The page has a header with 'Language English', 'Online Help', 'Logout', and the 'funkwerk' logo. The main content area is titled 'DynDNS Update' and 'DynDNS Provider'. It is divided into two sections: 'Basic Parameters' and 'Advanced Settings'. The 'Basic Parameters' section includes fields for Host Name, Interface (a dropdown menu), User Name, Password (masked with dots), Provider (a dropdown menu), and an 'Enable update' checkbox. The 'Advanced Settings' section includes fields for Mail Exchanger (MX) and Wildcard, with an 'Enabled' checkbox. At the bottom are 'OK' and 'Cancel' buttons.

Fig. 169: Local Services -> DynDNS Client -> DynDNS Update -> New

The **Local Services -> DynDNS Client -> DynDNS Update -> New** menu consists of the following fields:

Fields in the DynDNS Update Basic Parameters menu

Field	Description
Host Name	Enter the complete host name as registered with the DynDNS provider.
Interface	Select the WAN interface whose IP address is to be propagated over the DynDNS service (e.g. the interface of the Internet Service Provider).
User Name	Enter the user name as registered with the DynDNS provider.
Password	Enter the password as registered with the DynDNS provider.
Provider	Select the DynDNS provider with which the above data is registered. A choice of DynDNS providers is already available in the unconfigured state and their protocols are supported.

Field	Description
	<p>Other DynDNS providers can be configured in the Local Services -> DynDNS Client-> DynDNS Providers menu.</p> <p>The default value is <i>DynDNS</i> .</p>
Enable Update	<p>Select whether the DynDNS entry configured here is to be activated.</p> <p>The function is activated by choosing <i>Enabled</i>.</p> <p>The function is disabled by default.</p>

The **Advanced Settings** menu consists of the following fields:

Fields in the Advanced Settings menu

Field	Description
Mail Exchanger (MX)	<p>Enter the full host name of a mail server to which e-mails are to be forwarded if the host currently configured is not to receive mail.</p> <p>Ask your provider about this forwarding service and make sure e-mails can be received from the host entered as MX.</p>
Wildcard	<p>Select whether the forwarding of all subdomains of the Host Name are to be enabled for the current IP address of the Interface (advanced name resolution).</p> <p>The function is activated by choosing <i>Enabled</i>.</p> <p>The function is disabled by default.</p>

14.2.2 DynDNS Provider

In the **Local Services -> DynDNS Client -> DynDNS Providers** menu, a list of all configured DynDNS providers is shown.

14.2.2.1 New

Choose the **New** button to set up new DynDNS providers.

The screenshot shows the configuration page for a DynDNS Provider. The interface includes a navigation menu on the left with categories like System Management, Physical Interfaces, LAN, Wireless LAN, Routing, WAN, VPN, Firewall, VoIP, Local Services, and Maintenance. The 'Local Services' menu is expanded to show 'DynDNS Client'. The main content area is titled 'DynDNS Update' and 'DynDNS Provider'. It features a 'Basic Parameters' table with the following fields:

Basic Parameters	
Provider Name	<input type="text"/>
Server	<input type="text"/>
Update Path	<input type="text"/>
Port	80
Protocol	DynDNS
Update Interval	300 Seconds

At the bottom of the form are 'OK' and 'Cancel' buttons.

Fig. 170: Local Services -> DynDNS Client -> DynDNS Providers -> New

The **Local Services -> DynDNS Client -> DynDNS Provider -> New** menu consists of the following fields:

Fields in the DynDNS Provider Basic Parameters menu

Field	Description
Provider Name	Enter a name for this entry.
Server	Enter the host name or IP address of the server on which the provider's DynDNS service runs.
Update Path	Enter enter the path on the provider's server that contains the script for managing the IP address of your device. Ask your provider for the path to be used.
Port	Enter the port at which your device is to reach your provider's server. Ask your provider for the relevant port. The default value is 80.

Field	Description
Protocol	<p>Select one of the protocols implemented.</p> <p>Possible values:</p> <ul style="list-style-type: none"> • <i>DynDNS</i> (default value) • <i>Static DynDNS</i> • <i>ODS</i> • <i>HN</i> • <i>DYNS</i> • <i>Gnudip-HTML</i> • <i>Gnudip-TCP</i> • <i>Custom DynDNS</i>
Update Interval	<p>Enter the minimum time (in seconds) that your device must wait before it is allowed to propagate its current IP address to the DynDNS provider again.</p> <p>The default value is 300 seconds.</p>

14.3 DHCP Server

You can configure your device as a DHCP (Dynamic Host Configuration Protocol) server.

Your device and each PC in your LAN requires its own IP address. One option for allocating IP addresses in your LAN is the Dynamic Host Configuration Protocol (DHCP). If you configure your device as a DHCP server, the device automatically assigns IP addresses to requesting PCs in the LAN from a predefined IP address pool. A PC sends out an ARP request and in turn receives its IP address assigned by your device. You therefore do not need to allocate fixed IP addresses to PCs, which reduces the amount of configuration work in your network. To do this, you set up a pool of IP addresses, from which your device assigns IP addresses to hosts in the LAN for a defined period of time. A DHCP server also transfers the addresses of the domain name server entered statically or by PPP negotiation (DNS), NetBIOS name server (WINS) and default gateway.

14.3.1 DHCP Pool

To activate your device as a DHCP server, you must first define IP address pools from which the IP addresses are distributed to the requesting clients.

In the **Local Services** -> **DHCP Server** -> **DHCP Pool** menu, a list of all configured IP ad-

dress pools is shown.

In the list, for each entry, you have the possibility under **Pool** of enabling or disabling the configured DHCP pools.

14.3.1.1 New

Choose the **New** button to set up new IP address pools. Choose the  icon to edit existing entries.

Fig. 171: Local Services -> DHCP Server -> DHCP Pool -> New

The **Local Services -> DHCP Server ->DHCP Pool -> New** menu consists of the following fields:

Fields in the DHCP Pool Basic Parameters menu

Field	Description
Interface	Select the interface over which the addresses defined in IP Range are to be assigned to DHCP clients. When a DHCP request is received over this Interface , one of the addresses from the address pool is assigned.
IP Address Range	Enter the first (first field) and last (second field) IP address of

Field	Description
	the IP address pool.
Pool Usage	<p>Specify whether the IP pool is used for DHCP requests in the same subnet or for DHCP requests that have been forwarded to your device from another subnet. In this case it is possible to define IP addresses from another network.</p> <p>Possible values:</p> <ul style="list-style-type: none"> • <i>Local</i> (default value): The DHCP pool is only used for DHCP requests in the same subnet. • <i>Local/Relay</i>: The DHCP pool is used for DHCP requests in the same subnet and from other subnets. • <i>Relay</i>: The DHCP pool is only used for DHCP requests forwarded from other subnets.

The **Advanced Settings** menu consists of the following fields:

Fields in the Advanced Settings menu

Field	Description
Gateway	<p>Select which IP address is to be transferred to the DHCP client as gateway.</p> <p>Possible values:</p> <ul style="list-style-type: none"> • <i>Use router as gateway</i>: The IP address defined for the Interface is transferred. • <i>No gateway</i> (default value): No IP address is sent. • <i>Specify</i>: Enter the corresponding IP address.
Lease Time	<p>Enter the length of time (in minutes) for which an address from the pool is to be assigned to a host.</p> <p>After the Lease Time (Minutes) expires, the address can be re-assigned by the server.</p> <p>The default value is <i>120</i>.</p>
DHCP Options	<p>Specify thwhich additional data is forwarded to the DHCP client.</p> <p>Possible values for Option:</p> <ul style="list-style-type: none"> • <i>Time Server</i> (default value): Enter the IP address of the

Field	Description
	<p>time server to be sent to the client.</p> <ul style="list-style-type: none"> • <i>DNS Server</i>: Enter the IP address of the DNS server to be sent to the client. • <i>DNS Domain Name</i>: Enter the DNS domain to be sent to the client. • <i>WINS/NBNS Server</i>: Enter the IP address of the WINS/NBNS server to be sent to the client. • <i>WINS/NBT Node Type</i>: Enter the type of the WINS/NBT node to be sent to the client. • <i>TFTP Server</i>: Enter the IP address of the TFTP server to be sent to the client. <p>Several entries are possible. Add new entries with the Add button.</p>

14.3.2 IP/MAC Binding

In the **Local Services** -> **DHCP Server** -> **IP/MAC Binding** menu a list is shown of all clients that have received an IP address from your device via DHCP.

You can now allocate an IP address from a defined IP address pool to specific MAC addresses. You can do this by selecting the **Static Binding** option in the list to convert a list entry as a fixed binding, or you manually create a fixed IP/MAC binding by configuring this in the **New** sub-menu.



Note

You can only create new static IP/MAC bindings if IP address ranges have been configured in **Local Services** -> **DHCP Server** -> **DHCP Pool**.

14.3.2.1 New

Choose the **New** button to set up new IP/MAC bindings.

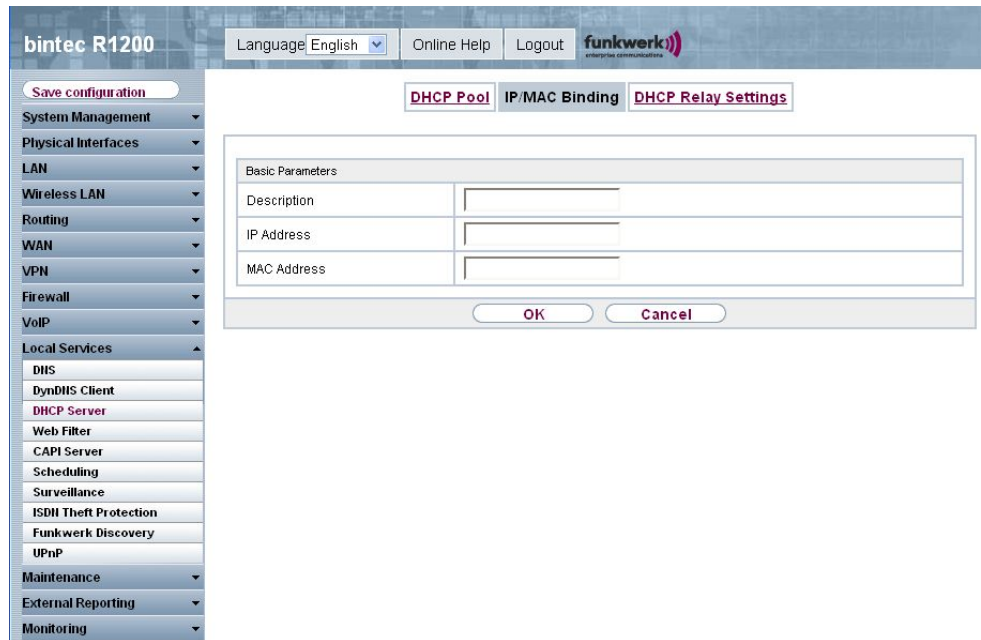

Fig. 172: Local Services -> DHCP Server -> IP/MAC Binding -> New

The **Local Services -> DHCP Server ->DHCP Binding -> New** menu consists of the following fields:

Fields in the IP/MAC Binding Basic Parameters menu

Field	Description
Description	Enter the name of the host to the MAC Address of which the IP Address is to be bound. A character string of up to 256 characters is possible.
IP Address	Enter the IP address to be assigned to the MAC address specified in MAC Address .
MAC Address	Enter the MAC address to which the IP address specified in IP Address is to be assigned.

14.3.3 DHCP Relay Setting

If your device for the local network does not distribute any IP addresses to the clients by DHCP, it can still forward the DHCP requests on behalf of the local network to a remote DHCP server. The DHCP server then assigns the your device an IP address from its pool, which in turn sends this to the client in the local network.

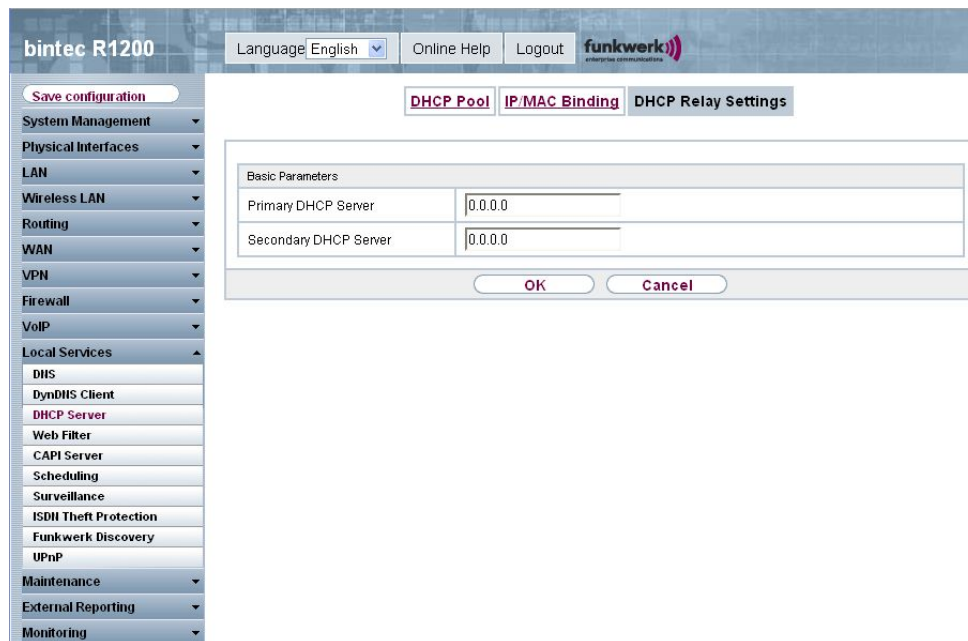

Fig. 173: Local Services -> DHCP Server -> DHCP Relay Settings

The **Local Services -> DHCP Server -> DHCP Relay Settings** menu consists of the following fields:

Fields in the DHCP Relay Settings Basic Parameters menu

Field	Description
Primary DHCP Server	Enter the IP address of a server to which BootP or DHCP requests are to be forwarded.
Secondary DHCP Server	Enter the IP address of an alternative BootP or DHCP server.

14.4 Web Filter

In the **Local Services** -> **Web Filters** menu, you can configure a URL-based Web filter service, which accesses the Proventia Web Filter from the company Internet Security Systems (www.iss.net) and checks how a requested Internet page is categorised by the Proventia Web Filter. The action resulting from the classification is configured on your device.

14.4.1 Global Settings

This menu contains the configuration of basic parameters for using the Proventia Web Filter.

The screenshot displays the configuration page for the Web Filter on a bintec R1200 device. The left sidebar shows the navigation menu with 'Local Services' expanded to 'Web Filter'. The top bar includes 'Language English', 'Online Help', 'Logout', and the 'funkwerk' logo. The main content area has four tabs: 'Global Settings' (selected), 'Filter List', 'Black / White List', and 'History'.

Web Filter Options

Enable Web Filter	<input checked="" type="checkbox"/>
Filtered Input Interface(s):	<input type="text"/> <input type="button" value="Add"/>
Maximum Number of History Entries	<input type="text" value="64"/>
URL Path Depth	<input type="text" value="1"/>
Action if server not reachable	<input checked="" type="radio"/> Allow all <input type="radio"/> Block all <input type="radio"/> Log all
Action if license not registered	<input checked="" type="radio"/> Allow all <input type="radio"/> Block all <input type="radio"/> Log all

License Information

Licence Key	<input type="text" value="B1BT"/> <input type="button" value="[Activate 30 days demo licence]"/>
Licence Status	<div style="border: 1px solid gray; height: 100px; width: 100%;"></div>
Licence valid until	<input type="text" value="Not activated"/>

Fig. 174: Local Services -> Web Filters -> Global Settings

The menu **Lokale Dienste** -> **Web Filters** -> **Global Settings** consists of the following fields:

Fields in the Global Settings Web Filter Options menu

Field	Description
Enable Web Filter	<p>Activate or deactivate the filter.</p> <p>The function is activated by choosing <i>Enabled</i>.</p> <p>The function is disabled by default.</p>
Filtered input interface(s)	<p>Select for which of the existing Ethernet interfaces web filtering is to be activated.</p> <p>Press the Add button to add more interfaces. The requests from http Internet pages that reach your device via these interfaces are then monitored by web filtering.</p>
Maximum number of history entries	<p>Define the number of entries to be saved in the web filtering history (History menu).</p> <p>Possible values are 1 to 512.</p> <p>The default value is 64.</p>
URL Path Depth	<p>Select the path length to which a URL is to be checked by the Cobion Orange Filter.</p>
Action if Server not reachable	<p>Select which is to be done with URL requests if the web filtering server cannot be reached.</p> <p>Possible values:</p> <ul style="list-style-type: none"> • <i>Allow all</i> (default value): The download is permitted. • <i>Block all</i>: The download of the requested page is blocked. • <i>Log all</i>: The download is permitted, but logged.
Action if license not registered	<p>Select what is to be done with URL requests if the licence key status is <i>Not Valid</i>.</p> <p>Possible values:</p> <ul style="list-style-type: none"> • <i>Allow all</i> (default value): The download is permitted. • <i>Block all</i>: The download of the requested page is blocked. • <i>Log all</i>: The download is permitted, but logged.

The **License Information** menu consists of the following fields:

Fields in the Global SettingsLicense Information menu

Field	Description
Licence Key	<p>Enter the number of your Proventia Web Filter licence. The pre-set code assigned by ISS designates the device type.</p> <p>In the ex works state, you can activate a 30-day demo version of the Proventia Web Filter. Click here on the link [Activate 30-day demo license]</p>
License Status	Shows the result of the last validity check of the licence. The validity of the licence is checked every 23 hours.
License valid until	This shows the expiry date of the licence (relative to the time set on your device) and cannot be edited.

14.4.2 Filter List

In the **Local Services -> Web Filters -> Filter List** menu, configure which categories of Internet pages are to be handled and how.

You configure the relevant filters for this purpose. A list of filters already configured is displayed.

There are basically different approaches for configuring the filters:

- First a filter list can be created that only contains entries for those addresses that are to be blocked. In this case it is necessary to make an entry at the end of the filter list that allows all accesses that do not match a filter. (Setting for this: **Category** = *Default Behavior*, **Action** = *Permit* or *Permit and Log*)
- If you only create entries for those addresses that are to be allowed or logged, it is not necessary to change the default behaviour (= all other calls are blocked).

14.4.2.1 New

Choose the **New** button to set up new filters.

The screenshot shows the bintec R1200 web interface. At the top, there is a header with 'bintec R1200', a language dropdown set to 'English', 'Online Help', 'Logout', and the 'funkwerk' logo. Below the header is a navigation bar with tabs for 'Global Settings', 'Filter List', 'Black / White List', and 'History'. The 'Filter List' tab is active. On the left, a sidebar menu shows 'Local Services' expanded to 'Web Filter'. The main content area displays the 'Filter Parameters' form with the following fields:

- Category: Pornography / Nudity (dropdown)
- Day: Everyday (dropdown)
- Schedule (Start / Stop Time): From 00:00 to 00:00
- Action: Allow Allow and Log Block and Log

At the bottom of the form are 'OK' and 'Cancel' buttons.

Fig. 175: Local Services -> Web Filters -> Filter List

The **Local Services -> Web Filter -> Filter List** menu consists of the following fields:

Fields in the Filter List Filter Parameters menu

Field	Description
Category	<p>Select which category of addresses/URLs the filter is to be used on.</p> <p>The options are first the standard categories of the Proventia Web Filter (default value: <i>Pornography/Nudity</i>). Actions can also be defined for the following special cases, e.g.:</p> <ul style="list-style-type: none"> • <i>Default behaviour</i>: This category applies to all Internet addresses. • <i>Other Category</i>: Some addresses are already known to the Proventia Web Filter, but not yet classified. The action associated with this category is used for such addresses. • <i>Unknown URL</i>: If an address is not known to the Proventia

Field	Description
	Web Filter, the action associated with this category is used.
Day	<p>Select the days on which the filter is to be active.</p> <p>Possible settings:</p> <ul style="list-style-type: none"> • <i>Daily</i> (default value): The filter is used every day of the week. • <i><Weekday></i>: The filter is used on a certain day of the week. Only one day can be selected per filter; several filters must be configured if several individual days are to be covered. • <i>Monday-Friday</i>: The filter is used from Monday to Friday. The default value is <i>Daily</i>.
Schedule (Start/Stop Time)	<p>In from, enter from which time the the filter is to be activated. The time is entered in the form hh:mm. The default value is 00:00. In to, enter the time at which the filter is to be deactivated. The time is entered in the form hh:mm. The default value is 00:00.</p>
Action	<p>Select the action to be executed if the filter matches a call.</p> <p>Possible values:</p> <ul style="list-style-type: none"> • <i>Block and Log</i> (default value): The call of the requested page is prevented and logged. • <i>Allow and Log</i>: The download is permitted, but logged. The events log can be viewed in the Local Services -> Web Filters -> Filter List menu. • <i>Allow</i>: The call is allowed and not logged.

14.4.3 Black / White list

The menu **Local Services -> Web Filters -> Black / White List** contains a list of URLs and IP addresses that can be downloaded even if they were blocked as a result of the filter configuration and classification in the Proventia Web Filter (no entries are contained in the default configuration).

14.4.3.1 Add

Use the **Add** button to add further URLs or IP addresses to the list.

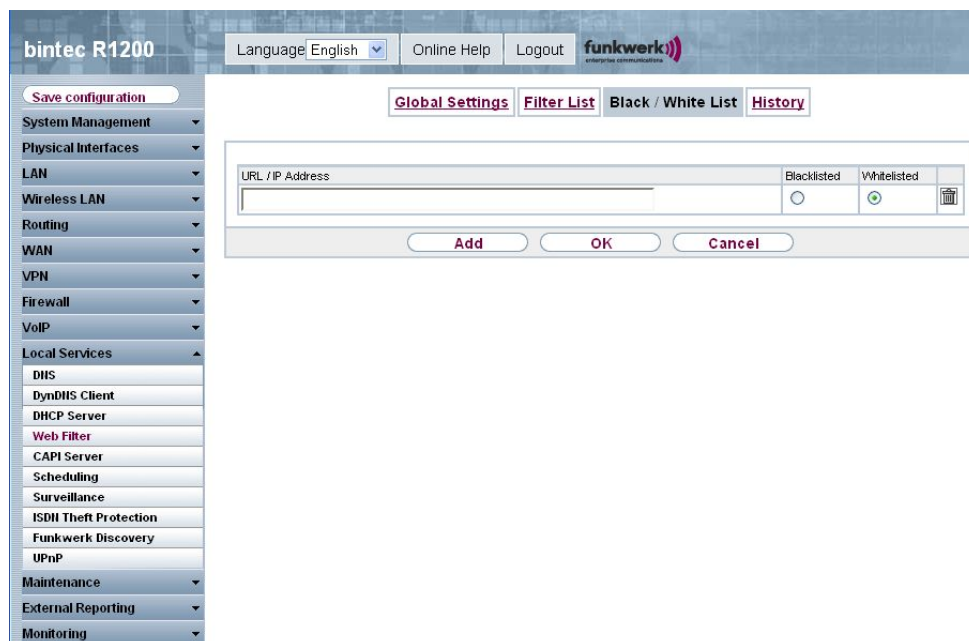

Fig. 176: Local Services -> Web Filters -> Black / White List-> Add

The **Local Services -> Web Filter -> Black / White List->Add** menu consists of the following fields:

Fields in the Black / White List menu

Field	Description
URL/IP-Address	You enter a URL or IP address. The length of the entry is limited to 60 characters.
Blacklisted Whitelisted	<p>You can select whether a URL or IP address can always (<i>in the White List</i>) or never (<i>in the Black List</i>) be downloaded.</p> <p><i>Whitelisted</i> is enabled by default.</p> <p>Addresses listed in the White List are allowed automatically. It is not necessary to configure a suitable filter.</p>

14.4.4 History

In the **Local Services** -> **Web Filter** -> **History** menu, you can view the recorded history of the web filter. The history logs all requests that are marked for logging by a relevant filter (**Action** = *Log*), likewise all rejected requests.

The screenshot shows the web interface for a bintec R1200 device. The top header includes 'bintec R1200', 'Language English', 'Online Help', 'Logout', and the 'funkwerk' logo. The left navigation menu is expanded to 'Local Services', with 'Web Filter' selected. The main content area has tabs for 'Global Settings', 'Filter List', 'Black / White List', and 'History'. Below the tabs is a search bar with 'View 20 per page' and 'Filter in None equal'. A table with columns '#', 'Date', 'Time', 'Source', 'URL', 'Category', and 'Result' is visible, with 'Page: 1' at the bottom left.

Fig. 177: Local Services -> Web Filters -> History

14.5 CAPI Server

You can use the CAPI Server function to assign user names and passwords to users of the CAPI applications on your device. This makes sure that only authorised users can receive incoming calls and make outgoing calls via CAPI.

The CAPI service allows connection of incoming and outgoing data and voice calls to communications applications on hosts in the LAN that access the Remote CAPI interface of your device. This enables, for example, hosts connected to your device to receive and send faxes.



Note

In the ex works state, a user with the user name *default* and no password is always entered for the CAPI subsystem. All calls to the CAPI are offered to all CAPI applications in the LAN.

Use the Settings menu to distribute incoming calls for the CAPI subsystem to defined users with password. You should then delete the user *default* without password.

14.5.1 User

In the **Local Services -> CAPI Server -> Users** menu, a list of all configured CAPI users is shown.

14.5.1.1 New

Choose the **New** button to set up new CAPI users.

The screenshot shows the web interface for a bintec R1200 device. The top navigation bar includes 'Language English', 'Online Help', 'Logout', and the 'funkwerk' logo. A left sidebar menu is expanded to 'Local Services', with 'CAPI Server' selected. The main content area shows a 'User Options' dialog box with the following fields:

Basic Parameters	
User Name	<input type="text"/>
Password	<input type="password"/>
Access	<input checked="" type="checkbox"/> Enabled

At the bottom of the dialog are 'OK' and 'Cancel' buttons.

Fig. 178: Local Services -> CAPI Server -> Users -> New

The **Local Services -> CAPI Server ->Users -> New** menu consists of the following fields:

Fields in the Users Basic Parameters menu

Field	Description
User name	Enter the user name for which access to the CAPI service is to be allowed or denied.
Password	Enter the password with which the user Username has to use for identification purposes to gain access to the CAPI service.
Access	Select whether access to the CAPI service is to be permitted or denied for the user. The function is activated by choosing <i>Enable</i> . The function is enabled by default.

14.5.2 Options

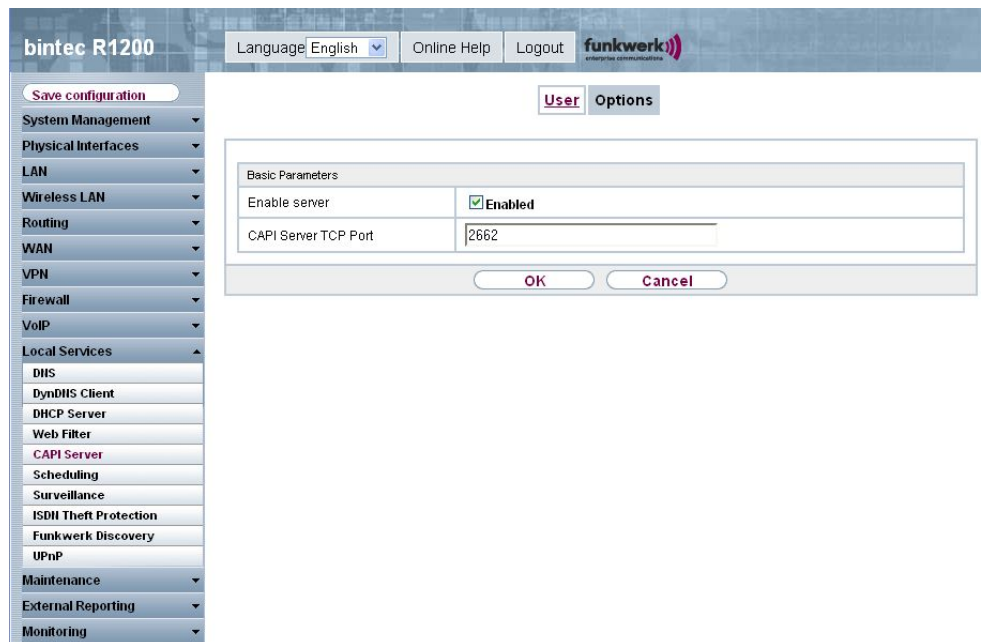

Fig. 179: Local Services -> CAPI Server ->Options

The **Local Services -> CAPI Server ->Options** menu consists of the following fields:

Fields in the Options Basic Parameters menu

Field	Description
Enable Server	Select whether your device is to be enabled as a CAPI server. The function is activated by choosing <i>Enabled</i> . The function is enabled by default.
CAPI Server TCP Port	The field can only be edited if Server Enable is enabled. Enter the TCP port number for remote CAPI connections. The default value is <i>2662</i> .

14.6 Scheduling

Your device has a event scheduler, which enables certain standard actions (activation or deactivation of interfaces) to be carried out on a time-dependent basis.



Note

To run the event scheduler, the date configured on your device must be 1.1.2000 or later.

14.6.1 Schedule

In the **Local Services** -> **Scheduling** -> **Schedule** menu, a list of all scheduled tasks is shown.

14.6.1.1 New

Choose the **New** button to set up new tasks.

Fig. 180: Local Services -> Scheduling -> Time Schedule -> New

The **Local Services -> Scheduling -> Schedule-> New** menu consists of the following fields:

Fields in the Time Schedule Basic Parameters menu

Field	Description
Description	Enter the desired name for the scheduled task.

Fields in the Time Schedule Action menu

Field	Description
Select Action	<p>Select the desired action.</p> <p>Possible values:</p> <ul style="list-style-type: none"> • <i>Reboot Device</i> (default value): Your device is rebooted. • <i>Activate Interface</i> : The interface defined in the Select Interface field is activated. • <i>Deactivate Interface</i> : The interface defined in the Select Interface field is deactivated. • <i>Activate WLAN</i>: The WLAN interface defined in the Select Interface field is activated.

Field	Description
	<ul style="list-style-type: none"> • <i>Deactivate WLAN</i>: The WLAN interface defined in the Select Interface field is deactivated. • <i>Initiate 5 GHz WLAN Bandscan</i>: The wireless module selected in Select Wireless Module is scanned in the 5-GHz frequency band. During the scan, all wireless connections are interrupted. • <i>Trigger software update</i>: A software update is initiated. • <i>Trigger configuration backup</i>: The backup of the device configuration to a TFTP server is initiated.
Select radio	<p>Only if Select Action = <i>Initiate 5 GHz WLAN Bandscan</i></p> <p>Select the radio module to be used for the scan.</p>
Select Interface	<p>Only if Select Action = <i>Activate Interface</i> or <i>Deactivate Interface</i></p> <p>or if</p> <p>Select Action = <i>Activate WLAN</i> or <i>Deactivate WLAN</i></p> <p>Select which interface is to be activated or deactivated.</p>
Source Location	<p>Only if Select action = <i>Trigger software update</i></p> <p>Select the desired source.</p> <p>Possible values:</p> <ul style="list-style-type: none"> • <i>Current software from Funkwerk server</i>: The latest software will be downloaded from the Funkwerk server. • <i>HTTP server</i>: The latest software will be downloaded from an HTTP server that you define in <i>Update URL</i>.
Update URL	<p>Only if Select Action = <i>Trigger software update</i> and Source = <i>HTTP Server</i></p> <p>Enter the name of the HTTP server from which you wish to download a configuration file.</p>
TFTP server	<p>Only if Select action = <i>Trigger configuration backup</i></p> <p>Enter the IP address of the TFTP server to which you wish to transfer a configuration file.</p>

Field	Description
TFTP File Name	<p>Only if Select action = <i>Trigger configuration backup</i></p> <p>Enter the name with which configuration file is to be transferred to the TFTP server.</p>

Fields in the Time Schedule Select time interval menu

Field	Description
Time Condition	<p>First select the type of time entry in Condition Type.</p> <p>Possible values:</p> <ul style="list-style-type: none"> • <i>Weekday</i> (default value): In Condition Settings , select a weekday. • <i>Periods</i>: In Condition Settings , select a particular period. • <i>Day of Month</i>: In Condition Settings , select a particular day of the month. <p>Possible values for Condition Settings with Condition Type = <i>Weekday</i>:</p> <p><i>Monday</i> (default value) ... <i>Sunday</i>.</p> <p>Possible values for Condition Settings with Condition Type = <i>Periods</i>:</p> <ul style="list-style-type: none"> • <i>Daily</i>: The initiator becomes active daily (default value). • <i>Monday-Friday</i>: The initiator becomes active daily from Monday to Friday. • <i>Monday-Saturday</i> : The initiator becomes active daily from Monday to Saturday. • <i>Saturday - Sunday</i> : The initiator becomes active on Saturdays and Sundays. <p>Possible values for Condition Settings with Condition Type = <i>Day of the month</i>:</p> <p><i>1</i> ... <i>31</i>.</p>
Start Time	<p>Enter the time from which the initiator is to be activated. Activation is carried on the next scheduling interval. the default value of this interval is 55 seconds.</p>

Field	Description
Stop Time	Enter the time from which the initiator is to be deactivated. Deactivation is carried on the next scheduling interval. If you do not enter a Stop Time or set Stop Time = Start Time , the initiator is activated and deactivated after 10 seconds.

14.6.2 Options

In the **Local Services** -> **Scheduling** -> **Options** menu, you configure the schedule interval.

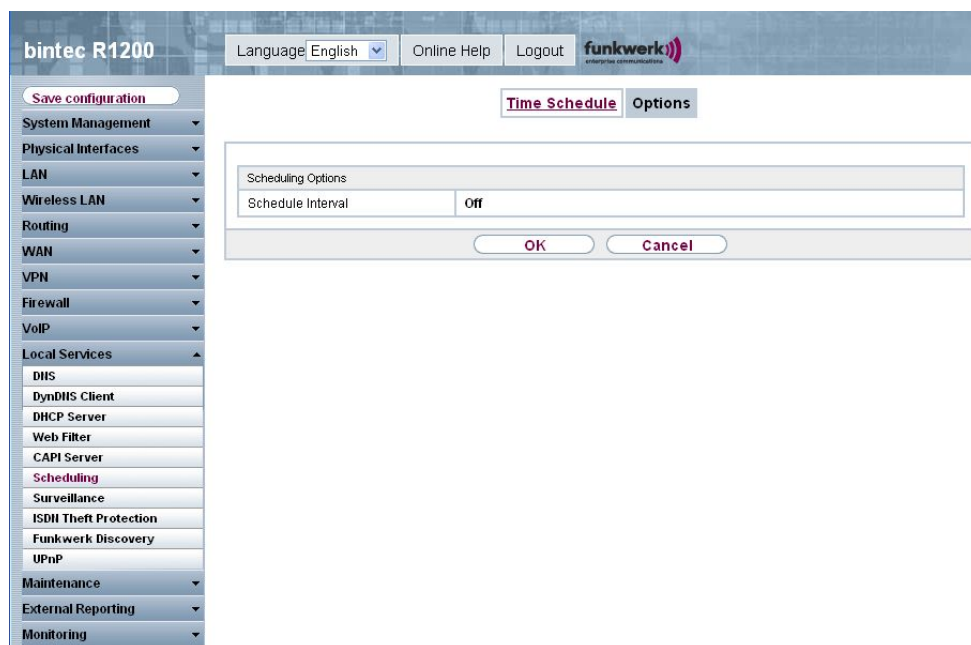

Fig. 181: Local Services -> Scheduling-> Options

The **Local Services** -> **Scheduling** -> **Options** menu consists of the following fields:

Fields in the Options Scheduling Options menu

Field	Description
Schedule Interval	Enter the interval in seconds during which the system checks whether there are planned tasks. Possible values are 0 to 65535.

Field	Description
	<p>The value <code>300</code> is recommended (5 minute accuracy). Values lower than <code>60</code> are generally pointless and are an unnecessary use of system resources.</p> <p>If <code>0</code> is displayed in this field, the scheduler is deactivated.</p>

14.7 Surveillance

In this menu, you can configure an automatic availability check for hosts or interfaces and automatic ping tests.



Note

This function cannot be configured on your device for connections that are authenticated via a RADIUS server.

14.7.1 Hosts

In the **Local Services** -> **Surveillance** -> **Hosts** menu, a list of all monitored hosts is shown.

The screenshot shows the web interface for bintec R1200. The top bar includes 'Language English', 'Online Help', 'Logout', and the 'funkwerk' logo. The left navigation menu is expanded to 'Local Services' -> 'Surveillance' -> 'Hosts'. The main content area has tabs for 'Hosts', 'Interfaces', and 'Ping Generator'. Below the tabs is a table with the following data:

Group ID	Monitored IP Address	Status	Interface Action	Interface		
0	0.0.0.0		Disable	en1-0		

Below the table is a 'New' button.

Fig. 182: Local Services -> Surveillance -> Hosts

Values in the list Hosts

Field	Description
Group ID	Shows the chosen group ID.
Monitored IP Address	Shows the IP address to be monitored.
Status	Displays the operating state of the monitored IP address.
Interface Action	Shows the chosen interface action.
Interface	Shows the interface to which the chosen interface action should be applied.

14.7.1.1 Edit/New

Choose the icon to edit existing entries. Choose the **New** button to set up new surveillance tasks servers.

Fig. 183: **Local Services -> Monitoring -> Hosts -> New**

The **Local Services -> Monitoring -> Hosts -> New** menu consists of the following fields:

Fields in the Hosts Host Parameters menu

Field	Description
Group ID	<p>Select an ID for the group of hosts whose availability is to be monitored by your device.</p> <p>The group IDs are automatically created from 0 to 255. If an entry has not yet been created, a new group is created using the <i>New ID</i> option. If entries have been created, you can select one from the list of created groups.</p> <p>Each host to be monitored must be assigned to a group.</p> <p>The action configured in Interface Action is only executed if no other group member can be reached.</p>

Fields in the Hosts Trigger menu

Field	Description
Monitored IP Address	Enter the IP address of the host to be monitored.

Field	Description
Source IP Address	<p>Select how the IP address is to be determined that your device uses as the source address of the packet sent to the host to be monitored.</p> <p>Possible values:</p> <ul style="list-style-type: none">• <i>Automatic</i> (default value): The IP address is determined automatically.• <i>Specific</i>: Enter the IP address in the adjacent input field.
Interval	<p>Enter the time interval (in seconds) to be used for checking the availability of hosts.</p> <p>Possible values are 1 to 65536.</p> <p>The default value is 10.</p> <p>The smallest Interval of the group members is used within a group.</p>
Trials	<p>Enter the number of pings that must remain unanswered for the host to be regarded as unavailable.</p> <p>Possible values are 1 to 65536.</p> <p>The default value is 3.</p>
Controlled interfaces	<p>Select the interface(s) for which the action defined in Interface Action is to be performed.</p> <p>All physical and virtual interfaces can be selected.</p> <p>Each interface, select whether each interface is to be activated (<i>Enable</i>) or deactivated (<i>Disable</i>, default value).</p>

14.7.2 Interfaces

In the **Local Services** -> **Monitoring** -> **Interfaces** menu, a list of all monitored Interfaces is shown.

The screenshot shows the web interface for a bintec R1200 device. The top navigation bar includes 'Language English', 'Online Help', 'Logout', and the 'funkwerk' logo. The left sidebar menu is expanded to 'Local Services', with 'Surveillance' and 'Interfaces' highlighted. The main content area displays a table of monitored interfaces:

Monitored Interface	Status	Trigger	Interface Action	Interface		
en1-0	🟢	Interface goes up	Enable	en1-0	🗑️	🔗

Below the table is a 'New' button.

Fig. 184: Local Services -> Surveillance -> Interfaces

Values in the list Interfaces

Field	Description
Monitored Interface	Shows the interface to be monitored.
Status	Shows the operating status of the selected interface.
Trigger	Displays the chosen state transition.
Interface Action	Shows the interface action.
Interface	Shows the interface to which the chosen interface action should be applied.

14.7.2.1 Edit/New

Choose the  icon to edit existing entries. Choose the **New** button to set up monitoring for other interfaces.

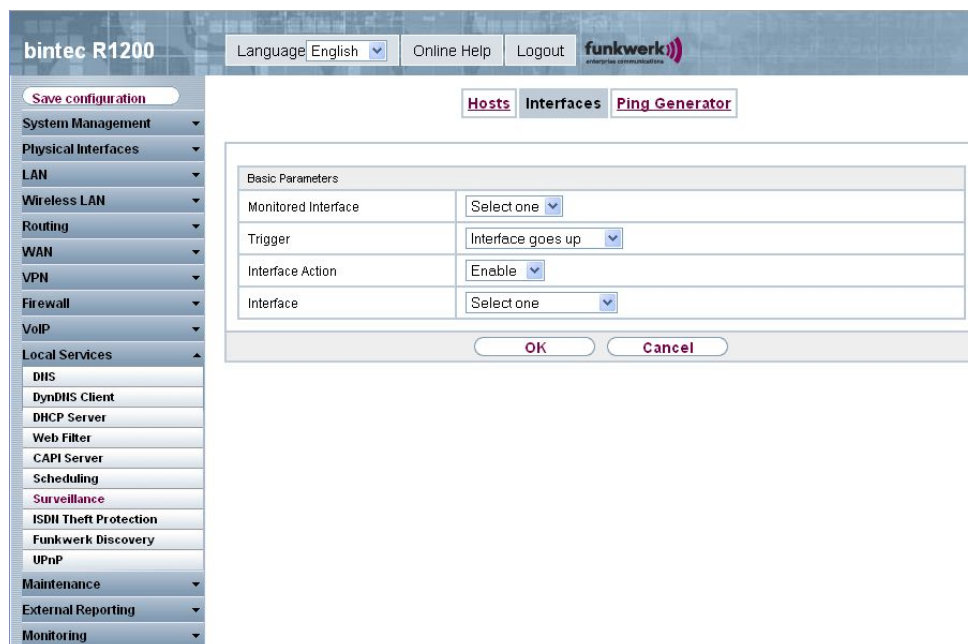

Fig. 185: **Local Services -> Monitoring -> Interfaces -> New**

The **Local Services -> Monitoring -> Interfaces -> New** menu consists of the following fields:

Fields in the Interfaces Basic Parameters menu

Field	Description
Monitored Interface	Select the interface on your device that is to be monitored.
Trigger	Select the state or state transition of Monitored Interfaces that is to trigger a particular Interface Action . Possible values: <ul style="list-style-type: none"> • <i>Interface goes up</i> (default setting) • <i>Interface goes down</i>
Interface Action	Select the action that is to follow the state or state transition defined in Trigger . The action is applied to the Interface(s) selected in Interface . Possible values: <ul style="list-style-type: none"> • <i>Enabled</i> (default value): Activation of interface(s)

Field	Description
	<ul style="list-style-type: none"> <i>Disabled</i> : Deactivation of interface(s)
Interface	<p>Select the interface(s) for which the action defined in Interface Action is to be performed.</p> <p>All the physical and virtual interfaces and the options <i>All PPP Interfaces</i> and <i>All IPSec Interfaces</i> can be selected.</p>

14.7.3 Ping Generator

In the **Local Services -> Monitoring -> Ping Generator** menu, a list is shown of all pings configured for automatic generation.

The screenshot shows the web interface for a bintec R1200 device. The top navigation bar includes 'Language English', 'Online Help', 'Logout', and the 'funkwerk' logo. The left sidebar menu is expanded to 'Local Services', with 'Surveillance' and 'Ping Generator' highlighted. The main content area has three tabs: 'Hosts', 'Interfaces', and 'Ping Generator'. Below the tabs is a table with the following structure:

Destination IP Address	Source IP Address	Interval	Status

Below the table is a 'New' button.

Fig. 186: Local Services -> Surveillance -> Ping Generator

Values in the list Ping Generator

Field	Description
Destination IP Address	Shows the IP address to which the ping is automatically sent.
Source IP Address	Shows the source IP address of the outgoing ICMP echo request packets.

Field	Description
Interval	Shows the interval in seconds during which the ping is sent to the specified address.
Status	Displays the operating state of the destination IP address.

14.7.3.1 Edit/New

Choose the  icon to edit existing entries. Choose the **New** button to set up further pings.

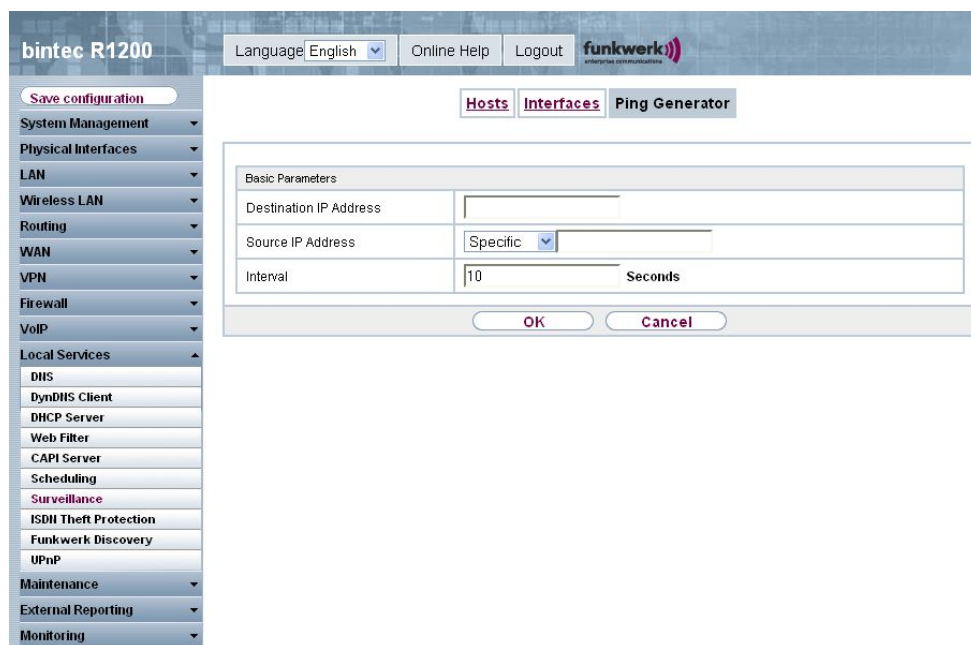

Fig. 187: Local Services -> Monitoring-> Ping Generator -> New

The **Local Services -> Monitoring -> Ping Generator -> New** menu consists of the following fields:

Fields in the Ping Generator Basic Parameters menu

Field	Description
Destination IP Address	Enter the IP address to which the ping is automatically sent.
Source IP Address	Enter the source IP address of the outgoing ICMP echo request packets. Possible values:

Field	Description
	<ul style="list-style-type: none"> • <i>Automatic</i>: The IP address is determined automatically. • <i>Specific</i> (default value): Enter the IP address in the adjacent input field e.g. to test a particular extended route.
Interval	<p>Enter the interval in seconds during which the ping is to be sent to the target IP address specified in Target IP Address.</p> <p>Possible values are 1 to 65536.</p> <p>The default value is 10.</p>

14.8 ISDN Theft Protection

With the ISDN theft protection function, you can prevent a thief who has stolen a gateway from gaining access to the gateway owner's LAN. (Without theft protection, he could dial in to the LAN by ISDN if, under **WAN-> Internet + Dialup->ISDN->**, the field **Always on** is enabled.)

14.8.1 Options

All interfaces for which the theft protection is enabled are administratively set to "down" when the gateway boots.

The gateway then calls itself by ISDN and checks its location. If the configured ISDN call numbers differ from the numbers dialled, the interfaces remain disabled.

If the numbers agree, the device assumes that it is at the original location and the interfaces are administratively set to "up".

To reduce cost, the function uses the ISDN D channel.



Note

Note that the ISDN theft protection function is not available for Ethernet interfaces.

The screenshot shows the 'bintec R1200' web interface. The top navigation bar includes 'Language English', 'Online Help', 'Logout', and the 'funkwerk' logo. The left sidebar contains a menu with 'Local Services' expanded to 'ISDN Theft Protection'. The main content area is titled 'Options' and contains two sections: 'Basic Parameters' and 'Advanced Settings'.

Basic Parameters:

- ISDN Theft Protection Service: Enabled
- Dialling Number:
- Incoming Number:
- Outgoing Number:
- Monitored Interfaces: Interface

Advanced Settings:

- Number of Dialling Retries:
- Timeout: Seconds

Buttons for 'OK' and 'Cancel' are located at the bottom of the 'Advanced Settings' section.

Fig. 188: **Local Services ->ISDN Theft Protection-> Options**

The menu **Local Services ->ISDN Theft Protection -> Options** consists of the following fields:

Fields in the Options Basic Parameters menu

Field	Description
ISDN Theft Protection Service	Enable or disable the ISDN theft protection function. The function is activated with <i>Enabled</i> . The function is disabled by default.
Dialling Number	Only if ISDN theft protection service is enabled. Enter the subscriber number that the gateway dials to call itself.
Incoming Number	Only if ISDN theft protection service is enabled. Enter the subscriber number to be compared with the current calling party number.
Number Called	Only if ISDN theft protection service is enabled. Enter the subscriber number to be set as calling party number.

Field	Description
Monitored interfaces	<p>Only if ISDN theft protection service is enabled.</p> <p>Use Add to add a new interface to the list.</p> <p>Select from the available interfaces those to which the ISDN theft protection function is to be applied.</p>

Fields in the Advanced Settings menu

Field	Description
Number of Dial Retries	<p>Enter the number of dial attempts that the gateway is to make to call itself by ISDN after a reboot.</p> <p>Possible values are <i>1</i> to <i>255</i>.</p> <p>The default value is <i>3</i>.</p>
Timeout	<p>Enter the time in seconds that the gateway is to wait before trying again after an unsuccessful attempt to call itself.</p> <p>Possible values are <i>2</i> to <i>20</i>.</p> <p>The default value is <i>5</i>.</p>

14.9 Funkwerk Discovery

14.9.1 Device discovery

The funkwerk Discovery protocol is used to identify and configure **bintec** access points that are in the same wired network as your device. Once an access point has been discovered, certain basic parameters (node name, IP address, netmask, and device address) can be configured on the access point (provided you know the administrator password).



Note

Any **bintec** access points that exist are determined by means of a multicast. The IP address of the access point is therefore irrelevant.

Please note that the discovered **bintec** access points are not stored in the flash, which means discovery must be repeated after you reboot your device.

In the **Local Services** -> **Funkwerk Discovery** -> **Device Discovery** menu, under **Results** a list is shown of all access points found on the network. In the **Ethernet interface** field, select the Ethernet interface of your device via which **bintec** access point discovery is to be carried out. You use the *-All-* option to query all Ethernet interfaces.

The current discovery status is displayed for each individual Ethernet interface under Discovery Status. *None* means that discovery is not active. *Discovery* is displayed when discovery is currently being carried out.

This discovery function also enables your device to be discovered and configured by other access points with a discovery function. You configure this in the **Options** sub-menu.

14.9.1.1 Discover

Choose the **Discover** button to start **bintec** access point discovery.

The screenshot shows the web interface for a bintec R1200 device. The top navigation bar includes 'Language English', 'Online Help', 'Logout', and the 'funkwerk' logo. The sidebar menu on the left is expanded to 'Local Services', which includes options like DHCP, DynDNS Client, DHCP Server, Web Filter, CAPI Server, Scheduling, Surveillance, ISDN Theft Protection, Funkwerk Discovery, UPnP, Maintenance, External Reporting, and Monitoring. The main content area is titled 'Device Discovery' and has an 'Options' sub-menu. It features an 'Automatic Refresh Interval' set to 60 seconds with an 'Apply' button. Below this, the 'Discovery Status' is shown as 'Discovery' for the 'en1-0' interface. There is a section to 'Initiate Funkwerk Discovery' with a dropdown menu set to '-All-'. The 'Results' section contains a table with the following data:

Interface	Node Name	IP Address / Mask	MAC Address	Last Write Result	
en1-0	wl3040	192.168.0.253 / 255.255.255.0	00:01:cd:06:1c:9e	No error	
en1-0	w1002	192.168.0.254 / 255.255.255.0	00:01:cd:0e:14:de	No error	
en1-0	w1002n	192.168.0.255 / 255.255.255.0	00:01:cd:0e:58:3e	No error	

At the bottom of the results section, there is a 'Discover' button.

Fig. 189: Local Services -> Funkwerk Discovery -> Device Discovery

If access points were discovered in the network, they are displayed in the list. You use the button to go to the configuration menu for the access point.

The screenshot shows the bintec R1200 web interface. The top navigation bar includes 'Language English', 'Online Help', 'Logout', and the 'funkwerk' logo. The left sidebar contains a menu with 'Local Services' expanded, showing options like 'DHIS', 'DynDHIS Client', 'DHCP Server', 'Web Filter', 'CAPI Server', 'Scheduling', 'Surveillance', 'ISDIH Theft Protection', 'Funkwerk Discovery', and 'UPnP'. The 'Funkwerk Discovery' menu is open, showing 'Device Discovery' and 'Options'. The 'Device Discovery' window displays the following configuration:

Basic Parameters	
Interface	en1-0
MAC Address	00:01:cd:06:1c:9e
Node Name	wi3040
IP Address	192.168.0.253
Netmask	255.255.255.0
Gateway	0.0.0.0
Authentication Password	
LastWrite Result	No error

Buttons for 'OK' and 'Cancel' are visible at the bottom of the window.

Fig. 190: Local Services -> Funkwerk Discovery -> Device Discovery->

The **Local Services -> Funkwerk Discovery -> Device Discovery->** menu consists of the following fields:

Fields in the Funkwerk Discovery Basic Parameters menu

Field	Description
Interface	The value of this field can only be read. Shows the interface of your device on which discovery is carried out.
MAC Address	The value of this field can only be read. Shows the MAC address of the discovered access point.
Node Name	You can change the name of the discovered access point.
IP Address	You can change the IP address of the discovered access point.
Netmask	You can change the related netmask.
Gateway	You can change the gateway address of the discovered access

Field	Description
	point.
Authentication Password	You must enter the administrator password for the access point, otherwise you cannot carry out the configuration operation.
Last Write Result	<p>The value of this field can only be read.</p> <p>Displays the result of the last configuration operation.</p> <p>Possible values:</p> <ul style="list-style-type: none">• <i>No Error</i>: The access point reported a successful operation or a configuration change has not yet been made with OK.• <i>No Response</i>: The access point has not responded.• <i>Access Denied</i>: The access point reported an authorisation error. Check the authentication password.• <i>Invalid IP Parameters</i>: There is a problem with the intended IP parameters (IP address, netmask, or gateway address).• <i>Destination Unreachable</i>: The access point cannot be reached for internal reasons (e.g. the interface to which the access point is connected is down). A configuration request cannot be sent to the access point.• <i>Other AP Error</i>: The access point responds to the configuration request with an unexpected or non-specific error.• <i>Internal Error</i>: An internal device problem prevented the configuration option from being carried out.

14.9.2 Options

In this menu, you can grant permission for your device to be discovered by other **bintec** devices using the funkwerk Discovery protocol and to be configured by means of this.

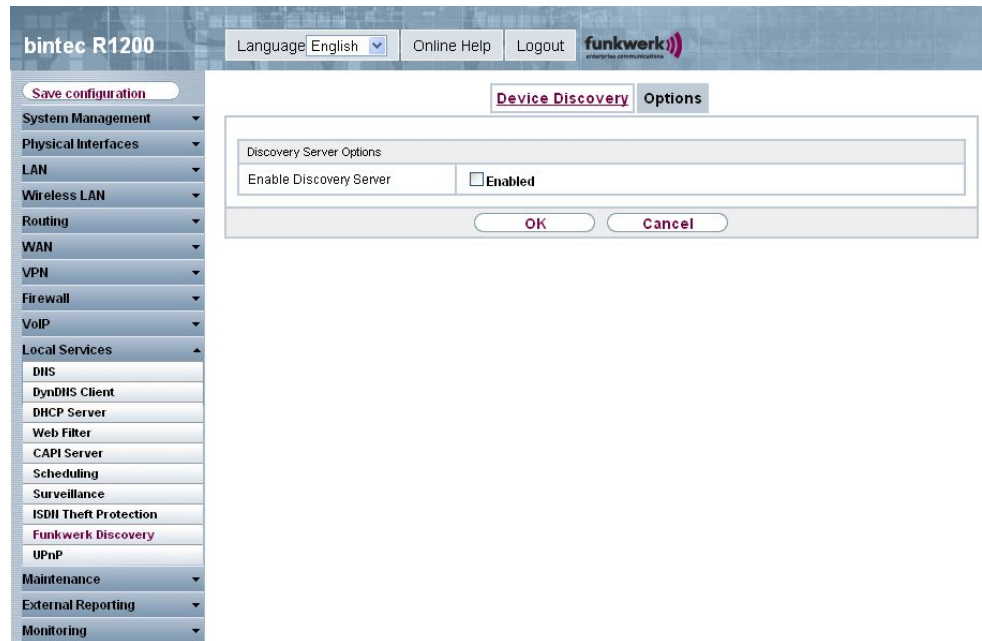

Fig. 191: Local Services -> Funkwerk Discovery -> Options

The **Local Services -> Funkwerk Discovery -> Options** menu consists of the following fields:

Fields in the Options Discovery Server Options menu

Field	Description
Enable Discovery Server	Select whether your device is to be discovered and configured by other bintec devices in the network. The function is activated with <i>Enabled</i> . The function is disabled by default.

14.10 UPnP

Universal Plug and Play (UPnP) makes it possible to use current messenger services (e.g. real time video/audion conferencing) as peer-to-peer communication where one of the peers lies behind a NAT-enabled gateway.

UPnP enables (mostly) Windows-based operating systems to take control of other devices with UPnP functionality on the local network. These include gateways, access points and print servers. No special device drivers are needed as known common protocols are used, such as TCP/IP, HTTP and XML.

Your gateway makes it possible to use the subsystem of the Internet Gateway Device (IGD) from the UPnP function range.

In a network behind a NAT-enabled gateway, the UPnP-configured computers act as LAN UPnP clients. To do this, the UPnP function on the PC must be enabled.

The pre-configured port used for UPnP communication between LAN UPnP clients and the gateway is `5678`. The LAN UPnP client acts as a so-called service control point, i.e. it recognizes and controls the UPnP devices on the network.

The ports assigned dynamically by, for example, MSN Messenger, lie in the range from `5004` to `65535`. The ports are released internally to the gateway on demand, i.e. when an audio/video transfer is started in Messenger. When the application is closed, the ports are immediately closed again.

The peer-to-peer-communication is initiated via public SIP servers with only the information from the two clients being forwarded. The clients then communicate directly with one another.

For further information about UPnP, see www.upnp.org.

14.10.1 Interfaces

In this menu, you configure the UPnP settings individually for each interface of your gateway.

You can determine whether UPnP requests from clients are accepted by each interface (for requests from the local network) and/or whether the interface can be controlled via UPnP requests.

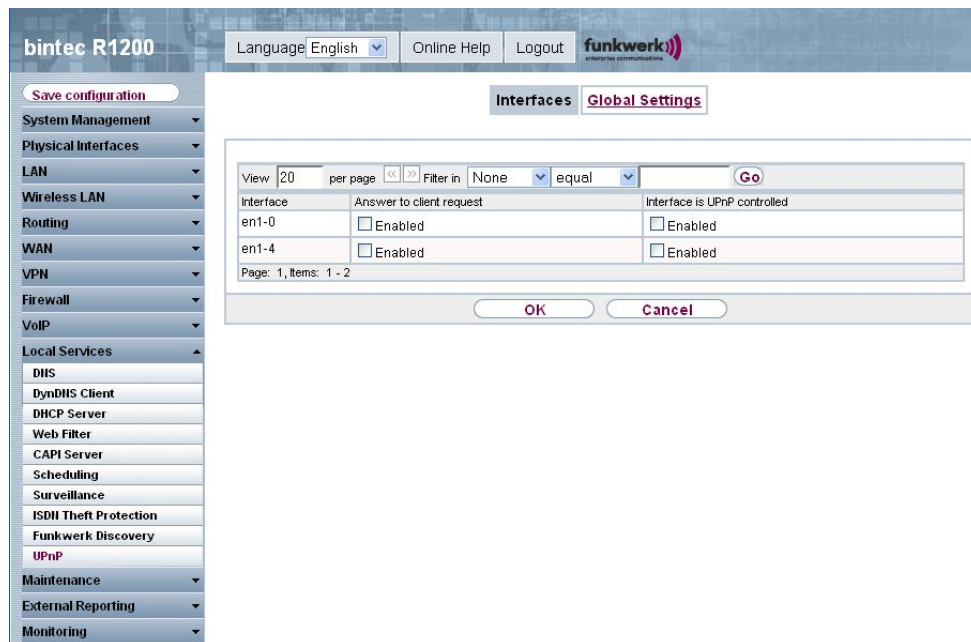

Fig. 192: Local Services -> UPnP -> Interfaces

The menu **Local Services ->UPnP-> Interfaces** consists of the following fields:

Fields in the Interfaces menu

Field	Description
Answer to client request	Determine whether UPnP requests from clients are to be answered via the particular interface (from the local network). The function is activated with <i>Enabled</i> . The function is disabled by default.
Interface is UPnP controlled	Determine whether the NAT configuration of this interface is controlled by UPnP. The function is activated with <i>Enabled</i> . The function is enabled by default.

14.10.2 Global Settings

In this menu, you make the basic UPnP settings.

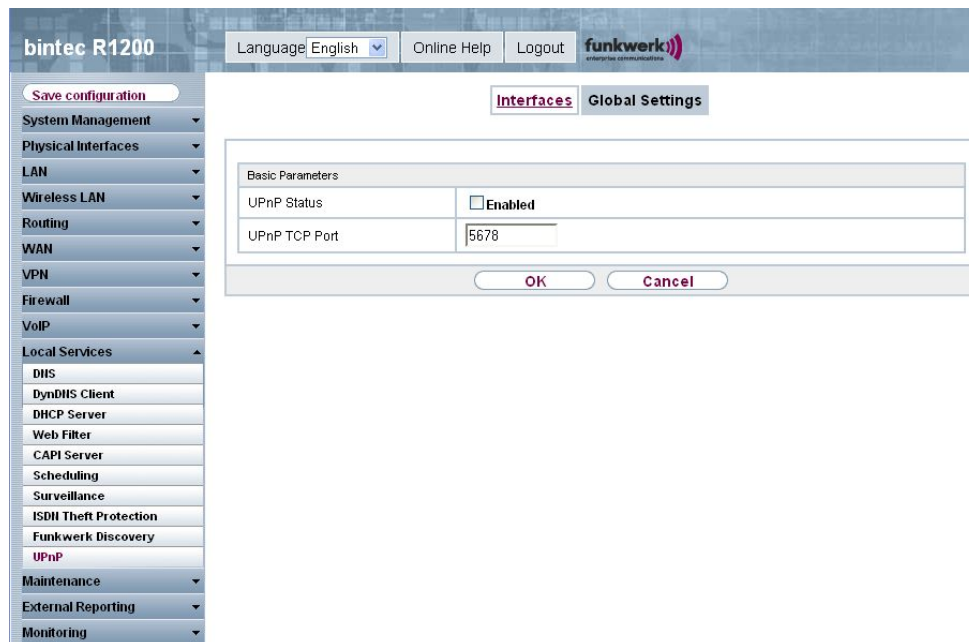

Fig. 193: Local Services -> UPnP -> Global Settings

The menu **Local Services ->UPnP-> Global Settings** consists of the following fields:

Fields in the Global Settings menu

Field	Description
UPnP Status	<p>Decide how the gateway processes UPnP requests from the LAN.</p> <p>The function is activated with <i>Enabled</i>. The gateway proceeds with UPnP releases in accordance with the parameters contained in the request from the LAN UPnP client, independently of the IP address of the requesting LAN UPnP client.</p> <p>The function is disabled by default. The gateway rejects UPnP requests, NAT releases are not made.</p>
UPnP TCP Port	<p>Enter the number of the port on which the gateway listens for UPnP requests.</p> <p>The possible values are 1 to 65535, the default value is 5678.</p>

Chapter 15 Maintenance

This menu provides you with numerous functions for maintaining your device. It firstly provides a menu for testing availability within the network. You can manage your system configuration files. If more recent system software is available, you can use this menu to install it. If you need other languages for the configuration interface, you can import these. You can also trigger a system reboot in this menu.

15.1 Diagnostics

In the **Maintenance** -> **Diagnosis** menu, you can test the accessibility of individual hosts, the resolution of domain names and certain routes.

15.1.1 Ping Test

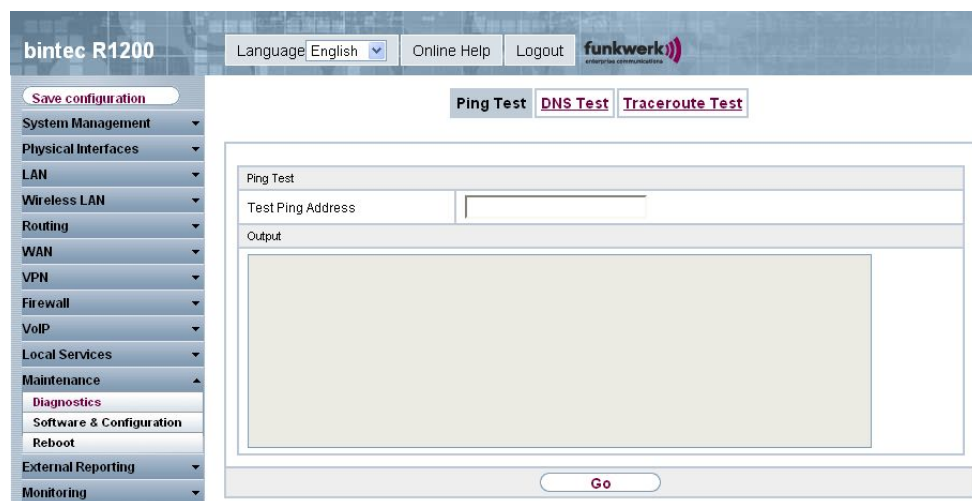

The screenshot displays the web interface for a bintec R1200 device. The top navigation bar includes the device name 'bintec R1200', a language dropdown set to 'English', and links for 'Online Help' and 'Logout'. The 'funkwerk' logo is also present. A left-hand sidebar menu lists various system management options, with 'Maintenance' expanded to show 'Diagnostics', 'Software & Configuration', and 'Reboot'. The main content area features three buttons: 'Ping Test' (highlighted), 'DNS Test', and 'Traceroute Test'. Below these buttons is a form titled 'Ping Test' with a 'Test Ping Address' input field and a large 'Output' text area. A 'Go' button is located at the bottom right of the form.

Fig. 194: **Maintenance** -> **Diagnosis** -> **Ping Test**

You can use the ping test to check whether a certain host in the LAN or an internet address can be reached. The **Output** field shows the ping test messages. The ping test is started by entering the IP address to be tested in **Send Ping Request to Address** and clicking on the **Go** button.

15.1.2 DNS Test

The screenshot displays the web management interface for a bintec R1200 device. The top navigation bar includes the device name 'bintec R1200', a language dropdown set to 'English', and links for 'Online Help' and 'Logout'. The 'funkwerk' logo is also present. A left-hand menu lists various system management categories, with 'Maintenance' expanded to show 'Diagnostics', 'Software & Configuration', and 'Reboot'. The 'Diagnostics' section is active, showing three test options: 'Ping Test', 'DNS Test', and 'Traceroute Test'. The 'DNS Test' page features a 'DNS Address' input field and a large 'Output' area for test results. A 'Go' button is located at the bottom of the form.

Fig. 195: Maintenance -> Diagnosis ->DNS Test

The DNS test is used to check whether the domain name of a particular host is correctly resolved. The **Output Results** field shows the DNS test messages. The DNS test is started by entering the domain name to be tested in **DNS Address** and clicking on the **Go** button.

15.1.3 Traceroute Test

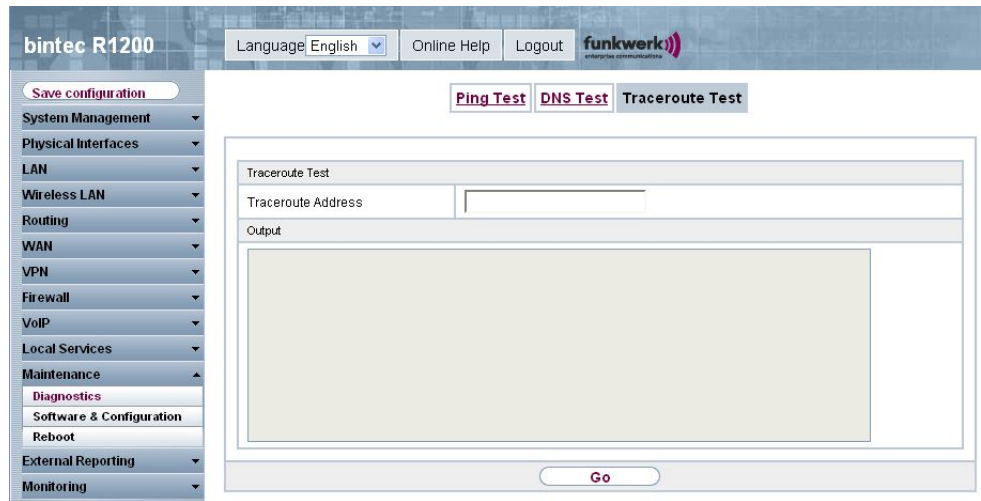

Fig. 196: Maintenance -> Diagnosis ->Traceroute Test

You use the traceroute test to display the route to a particular address (IP address or domain name), if this can be reached. The **Output** field shows the traceroute test messages. The traceroute test is started by entering the address to be tested in **Traceroute Address** and clicking on the **Go** button.

15.2 Software & Configuration

15.2.1 Options

You can use this menu to manage the software version of your device, your configuration files and the language of the **Funkwerk Configuration Interface**.

Your device contains the version of the system software available at the time of production. More recent versions may have since been released. You may therefore need to carry out a software update.

Every new system software includes new features, better performance and any necessary bugfixes from the previous version. You can find the current system software at www.funkwerk-ec.com. The current documentation is also available here.



Important

If you want to update your software, make sure you consider the corresponding release notes. These describe the changes implemented in the new system software.

The result of an interrupted update (e.g. power failure during the update) could be that your gateway no longer boots. Do not turn your device off during the update.

An update of BOOTmonitor and/or Logic is recommended in a few cases. In this case, the release notes refer expressly to this fact. Only update BOOTmonitor or Logic if Funkwerk Enterprise Communications GmbH explicitly recommends this.

Flash

Your device saves its configuration in configuration files in the flash EEPROM (Electrically Erasable Programmable Read Only Memory). The data even remains stored in the flash when your device is switched off.

RAM

The current configuration and all changes you set on your device during operation are stored in the working memory (RAM). The contents of the RAM are lost if the device is switched off. So if you modify your configuration and want to keep these changes for the next time you start your device, you must save the modified configuration in the flash memory before switching off: **Save Configuration** button in the **Funkwerk Configuration Interface** navigation area. This configuration is then saved in the flash in a file with the name `boot`. When you start your device, the `boot` configuration file is used by default.

Operations

The files in the flash memory can be copied, moved, erased and newly created. It is also possible to transfer configuration files between your device and a host via HTTP.

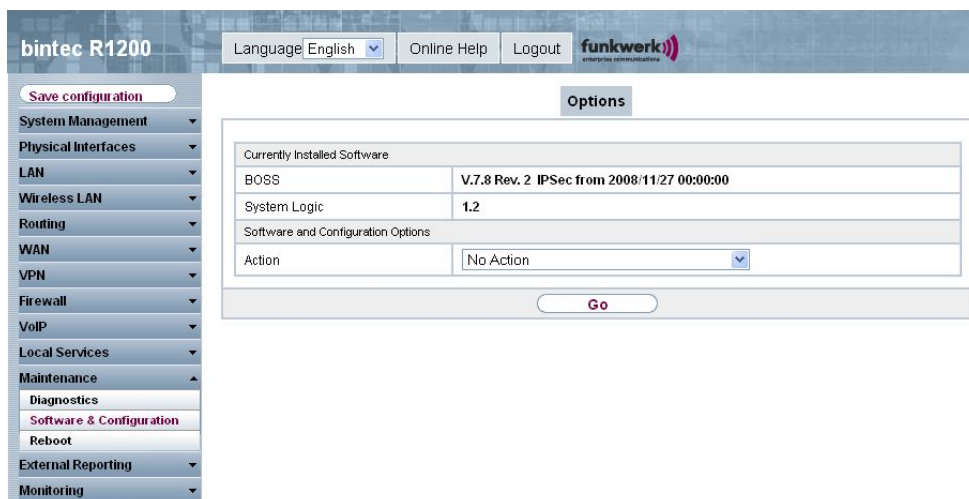

Fig. 197: Maintenance -> Software & Configuration -> Options

The **Maintenance -> Software & Configuration -> Options** menu consists of the following fields:

Fields in the Configuration Management Currently installed Software menu

Field	Description
BOSS	Shows the current software version loaded on your device.
System Logic	Shows the current system logic loaded on your device.
SHDSL Logic	Shows the current version of the SHDSL logic loaded on your device.
ADSL Logic	Shows the current version of the ADSL logic loaded on your device.

Fields in the Configuration Management Software and Configuration Options menu

Field	Description
Action	<p>Select the action you wish to execute.</p> <p>Possible values:</p> <ul style="list-style-type: none"> <i>No action</i> (default value): <i>Import configuration</i>: The configuration file that you select in Filename is transferred to the flash memory. Note: To activate, copy the configuration to the <i>boot</i> file or rename it

Field	Description
	<p>and reboot your device.</p> <ul style="list-style-type: none"> • <i>Import language</i>: You can import other language versions of the Funkwerk Configuration Interface into your device. You can download the files to your PC from the download area at www.funkwerk-ec.com and from there import them to your device. • <i>Update system software</i>: you can start an update of the system software, the ADSL logic and the BOOTmonitor. • <i>Export configuration</i>: The configuration file Current filename in flash memory is transferred to your local host. If you click on the Go button, a dialog box is shown, in which you can select the storage location on your PC and enter the desired file name. • <i>Export configuration with status information</i>: The active configuration from the RAM is transferred to your local host. If you click on the Go button, a dialog box is shown, in which you can select the storage location on your PC and enter the desired file name. • <i>Copy</i>: The configuration file in the Source File Name field is saved as Destination file name. • <i>Rename</i>: The configuration file in the Select File field is renamed as New Filename. • <i>Delete Configuration</i>: The configuration file in the Select File field is deleted. • <i>Delete File</i>: The file in the Select File field is deleted.
Configuration Encryption	<p>Only for Action = <i>Import configuration, Export configuration, Export configuration with status information</i>. Define whether the data of the selected Action are to be encrypted..</p> <p>The function is activated by choosing <i>Enabled</i>.</p> <p>The function is disabled by default.</p> <p>If the function is active, you can enter the Password in the text field.</p>
Filename	<p>Only for Action = <i>Import configuration, Import language, Update system software</i>. Enter the path and name of the file or select the file with Browse... via the explorer/finder.</p>

Field	Description
Source Location	<p>Only for Action = <i>Update system software</i></p> <p>Select the source for the update.</p> <p>Possible values:</p> <ul style="list-style-type: none"> • <i>Local File</i> (default value): The system software file is stored locally on your PC. • <i>HTTP server</i>: The file is stored on a remote server specified in the URL. • <i>Current software from Funkwerk server</i>: The file is on the official Funkwerk update server.
URL	<p>Only for Source = <i>HTTP server</i></p> <p>You enter the URL of the update server from which the system software file is loaded here.</p>
Current File Name in Flash	<p>For Action = <i>Export configuration</i> Choose the configuration file to be exported.</p>
Include Certificates and Keys	<p>For Action = <i>Export configuration, Export configuration with status information</i>, select whether the selected Action is also to apply for certificates and keys.</p> <p>The function is activated by choosing <i>Enabled</i>.</p> <p>The function is enabled by default.</p>
Source File Name	<p>Only for Action = <i>Copy</i> Select the source file to be copied.</p>
Destination File Name	<p>Only for Action = <i>Copy</i> Enter the name of the copy.</p>
Select File	<p>Only if Action = <i>Rename, Delete configuration</i> or <i>Delete file</i> Choose the file or configuration to be renamed or deleted.</p>
New File Name	<p>Only for Action = <i>Rename</i> Enter the new name of the configuration file.</p>

15.3 Reboot

15.3.1 System Reboot

In this menu, you can trigger an immediate reboot of your device. Once your system has restarted, you must call the **Funkwerk Configuration Interface** again and log in.

Pay attention to the LEDs on your device. For information on the meaning of the LEDs, see the **Technical Data** chapter of the manual.



Note

Before a reboot, make sure you confirm your configuration changes by clicking the **Save Configuration** button, so that these are not lost when you reboot.

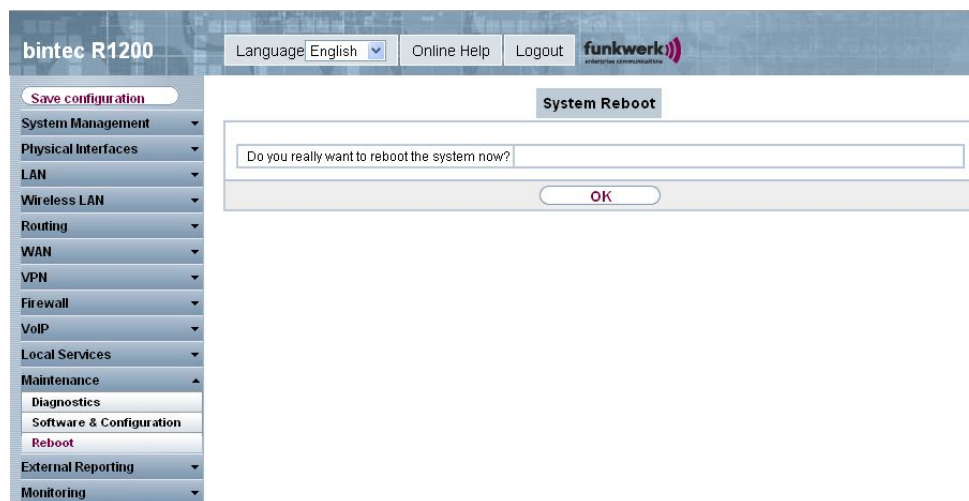

Fig. 198: Maintenance -> Reboot -> System Reboot

If you wish to reboot your device, enable the option **Yes** under **Do you really want to reboot the system now?** You press the **OK** button to start the reboot.

Chapter 16 External Reporting

16.1 Syslog

Events in various subsystems of your device (e.g. PPP) are logged in the form of syslog messages (system logging messages). The number of messages visible depends on the level set (eight levels from *Emergency* and *Information* to *Debug*).

In addition to the data logged internally on your device, all information can and should also be passed to one or more external PCs for storage and processing, e.g. to the system administrator's PC. The syslog messages saved internally on your device are lost when you reboot.



Warning

Make sure you only pass syslog messages to a safe computer. Check the data regularly and ensure that there is always enough spare capacity available on the hard disk of your PC.

Syslog Daemon

All Unix operating systems support the recording of syslog messages. For Windows PCs, the Syslog Demon included in the **DIME Tools** can record the data and distribute to various files depending on the contents (see **BRICKware** for Windows, which can be accessed at www.funkwerk-ec.com).

16.1.1 Syslog Servers

Configure your device as a syslog server so that defined system messages can be sent to suitable hosts in the LAN.

In this menu, you define which messages are sent to which hosts and with which conditions.

In the **External Reporting** -> **System Log** -> **Syslog Servers** menu, a list of all configured system log servers is shown.

16.1.1.1 New

Choose the **New** button to set up new syslog servers.

The screenshot shows the 'bintec R1200' web interface. At the top, there are links for 'Language English', 'Online Help', and 'Logout', along with the 'funkwerk' logo. The left sidebar contains a navigation menu with 'External Reporting' expanded to show 'Syslog', 'IP Accounting', 'E-mail Alert', 'SHMP', 'Activity Monitor', and 'Monitoring'. The main content area is titled 'Syslog Servers' and contains a 'Basic Parameters' form. The form fields are: IP Address (text input), Level (Information dropdown), Facility (local0 dropdown), Timestamp (radio buttons for None, Time, Date & Time, with None selected), Protocol (radio buttons for UDP, TCP, with UDP selected), and Type of Messages (radio buttons for System, Accounting, System & Accounting, with System & Accounting selected). At the bottom of the form are 'OK' and 'Cancel' buttons.

Fig. 199: External Reporting -> Syslog-> Syslog Servers -> New

The **External Reporting -> Syslog-> Syslog Servers -> New** menu consists of the following fields:

Fields in the Syslog Servers Basic Parameters menu

Field	Description
IP Address	Enter the IP address of the host to which syslog messages are passed.
Level	Select the priority of the syslog messages that are to be sent to the host. Possible values: <ul style="list-style-type: none"> • <i>Emergency</i> (highest priority) • <i>Alert</i> • <i>Critical</i> • <i>Error</i> • <i>Warning</i> • <i>Alert</i>

Field	Description
	<ul style="list-style-type: none"> • <i>Information</i> (default value) • <i>Debug</i> (lowest priority) <p>Syslog messages are only sent to the host if they have a higher or identical priority to that indicated, i.e. all messages generated are recorded at syslog level <i>Debug</i>.</p>
Facility	<p>Enter the syslog facility on the host.</p> <p>This is only required if the Log Host is a Unix computer.</p> <p>Possible values: <i>local0 - 7</i></p> <p>.</p> <p>The default value is <i>local0</i>.</p>
Timestamp	<p>Select the format of the time stamp in the syslog.</p> <p>Possible values:</p> <ul style="list-style-type: none"> • <i>None</i> (default value): No system time indicated. • <i>Time</i> : System time without date. • <i>Date & Time</i> : System time with date.
Protocol	<p>Select the protocol for the transfer of syslog messages. Note that the syslog server must support the protocol.</p> <p>Possible values:</p> <ul style="list-style-type: none"> • <i>UDP</i> (default value) • <i>TCP</i>
Type of Messages	<p>Select the message type.</p> <p>Possible values:</p> <ul style="list-style-type: none"> • <i>System & Accounting</i> (default value) • <i>System</i> • <i>Accounting</i>

16.2 IP Accounting

In modern networks, information about the type and number of data packets sent and received over the network connections is often collected for commercial reasons. This information is extremely important for Internet Service Providers that bill their customers by data volume.

However, there are also non-commercial reasons for detailed network accounting. If, for example, you manage a server that provides different kinds of network services, it is useful for you to know how much data is generated by the individual services.

Your device contains the IP Accounting function, which enables you to collect a lot of useful information about the IP network traffic (each individual IP session).

16.2.1 Interfaces

In this menu, you can configure the IP Accounting function individually for each interface.

The screenshot shows the web interface for a bintec R1200 device. The top navigation bar includes 'Language English', 'Online Help', 'Logout', and the 'funkwerk' logo. The left sidebar contains a menu with 'External Reporting' expanded to show 'IP Accounting' selected. The main content area is titled 'Interfaces' and contains a table with the following data:

#	Interface	IP Accounting Select all Deselect all
1	en1-0	<input type="checkbox"/>
2	en1-4	<input type="checkbox"/>

Below the table, there are 'OK' and 'Cancel' buttons. The interface also features a search and filter section at the top of the table area with 'View 20 per page', 'Filter in None', and 'equal' options.

Fig. 200: External Reporting -> IP Accounting-> Interfaces

In the **External Reporting -> IP Accounting -> Interfaces** menu, a list of all interfaces configured on your device is shown. For each entry, you can activate IP Accounting by setting the checkmark. In the **IP Accounting** column, you do not need to click each entry individually. Using the options **Select All** and **Disable All**, you can enable or disable the IP accounting function for all interfaces simultaneously.

16.2.2 Options

In this menu, you configure general settings for IP Accounting.



Fig. 201: External Reporting -> IP Accounting-> Options

In the **External Reporting -> IP Accounting -> Options** menu you can set the **Log Format** of the IP accounting messages. The messages can contain character strings in any order, sequences separated by a slash, e.g. \t or \n or defined tags.

Possible format tags:

Format tags for IP accounting messages

Field	Description
%d	Date of the session start in the format DD.MM.YY
%t	Time of the session start in the format HH:MM:SS
%a	Duration of the session in seconds
%c	Protocol
%i	Source IP Address
%r	Source Port
%f	Source interface index
%l	Destination IP Address
%R	Destination Port

Field	Description
%F	Destination interface index
%p	Packets sent
%o	Octets sent
%P	Packets received
%O	Octets received
%s	Sequential number for accounting message
%%	%

By default, the following format instructions are entered in the **Log Format** field. *INET* :
`%d%t%a%c%i:%r/%f -> %I:%R/%F%p%o%P%O[%s]`

16.3 E-mail Alert

It was previously possible to send syslog messages from the router to any syslog host. Depending on the configuration, E-mails are sent to the administrator as soon as relevant syslog messages occur.

16.3.1 E-mail Alert Server

The **E-mail Alert Server** menu consists of the following fields:

The screenshot shows the web interface for a bintec R1200 router. The top bar includes 'Language English', 'Online Help', 'Logout', and the 'funkwerk' logo. The left navigation menu is expanded to 'External Reporting', with 'E-mail Alert' selected. The main content area is titled 'E-mail Alert Server' and 'E-mail Alert Receiver'. The configuration form contains the following fields:

- Basic Parameters**
 - Alert Service: Enable
 - Sender E-Mail Address:
 - Maximum Messages per Minute: 6 (dropdown)
- SMTP Settings**
 - SMTP Server:
 - SMTP Authentication: None ESMTP SMTP after POP

At the bottom of the form are 'OK' and 'Cancel' buttons.

Fig. 202: External Reporting -> E-mail Alert-> E-mail Alert Server

The **External Reporting** -> **E-mail Alert**-> **E-mail Alert Server** menu consists of the following fields:

Fields in the E-mail Alert Server Basic Parameters menu

Field	Description
Alert service	Enable or disable the function.
Sender E-mail Address	Enter the mail address to be entered in the sender field of the E-mail.
Maximum Messages per Minute	Limit the number of outgoing mails per minute. Possible values are 1 to 15, the default value is 6.

Fields in the E-mail Alert Server SMTP Settings menu

Field	Description
SMTP Server	Enter the address (IP address or valid DNS name) of the mail server to be used for sending the mails. The entry is limited to 40 characters.
SMTP Authentication	Forward the incoming E-mails. Possible values: <ul style="list-style-type: none"> • <i>None</i> (default value): The E-mails are not forwarded. • <i>ESMTP</i>: The E-mails are forwarded to the destination over SMTP. • <i>SMTP after POP</i>: The E-mails are collected by the provider with POP and are forwarded to the destination over SMTP.
User name	Only if SMTP Authentication = <i>ESMTP</i> or <i>SMTP after POP</i> . Enter the name of the user.
Password	Only if SMTP Authentication = <i>ESMTP</i> or <i>SMTP after POP</i> . Enter the password of the user.
POP3 Server	Only if SMTP Authentication = <i>SMTP after POP</i> . Enter the address of the server from which the mails are to be retrieved. Appropriate POP3 server software must be installed so that the

Field	Description
	mailserver can answer the requests via POP3.
POP3 Timeout	<p>Only if SMTP Authentication = <i>SMTP after POP</i>.</p> <p>Enter how long the router must wait after a relevant event before it is forced to send the alert mail.</p> <p>The default value is 600 seconds.</p>

16.3.2 E-mail Alert Recipient

In the **E-mail Alert Recipient** menu, a list of syslog messages is displayed.

16.3.2.1 New

Choose the **New** button to create new E-mail Alert Recipients.

The screenshot shows the web interface for a bintec R1200 router. The top navigation bar includes 'Language English', 'Online Help', 'Logout', and the 'funkwerk' logo. A left sidebar menu is expanded to 'External Reporting', with sub-items like 'Syslog', 'IP Accounting', 'E-mail Alert', 'SHMP', 'Activity Monitor', and 'Monitoring'. The main content area is titled 'E-mail Alert Server' and 'E-mail Alert Receiver'. The 'Add / Edit E-mail Alert Receiver' form contains the following fields:

- Recipient: A text input field.
- Matching String: A text input field with a '(Wildcards)' label.
- Severity: A dropdown menu set to 'Emergency'.
- Message Timeout: A text input field with the value '60'.
- Number of Messages: A text input field with the value '1'.
- Message Compression: A checkbox labeled 'Enable' which is checked.
- Monitored Subsystems: A section with a 'Subsystem' dropdown and an 'Add' button.

At the bottom of the form are 'OK' and 'Cancel' buttons.

Fig. 203: External Reporting -> E-mail Alert-> E-mail Alert Recipient

The **External Reporting -> E-mail Alert-> E-mail Alert Recipient** menu consists of the following fields:

Fields in the E-mail Alert Recipient Add / Edit E-mail Alert Recipient menu

Field	Description
Recipient	Enter the E-mail address of the recipient. The entry is limited to 40 characters.

Field	Description
Matching String	<p>You must enter a "Matching String" here. This must occur in a syslog message as a necessary condition for triggering an alert.</p> <p>The entry is limited to 55 characters. Bear in mind that without the use of wildcards (e.g. "*"), only those strings that correspond exactly to the entry fulfill the condition. The "Matching String" entered therefore usually contains wildcards. To be informed of all syslog messages of the selected level, just enter "*".</p>
Severity	<p>Select the severity at which the string configured in the Matching String field must occur to trigger an E-mail alert.</p> <p>Possible values:</p> <p><i>Emergency (default value), Alert, Critical, Error, Warning, Notice, Information, Debug</i></p>
Message Timeout	<p>Enter how long the router must wait after a relevant event before it is forced to send the alert mail.</p> <p>Possible values are 0 to 86400. The value 0 disables the timeout.</p>
Number of Messages	<p>Enter the number of syslog messages that must be reached before an E-mail can be sent for this case. If timeout is configured, the mail is sent when this expires, even if the number of messages has not been reached.</p> <p>Possible values are 0 to 99; the default value is 0.</p>
Message Compression	<p>Select whether the text in the alert E-mail is to be shortened. The E-mail then contains the syslog message only once plus the number of relevant events.</p> <p>Enable or disable the field.</p> <p>The function is enabled by default.</p>

Fields in the E-mail Alert Recipient Monitored Subsystems menu

Field	Description
Subsystem	<p>HSelect the subsystems to be monitored.</p> <p>Add a new system with Add.</p>

16.4 SNMP

SNMP (Simple Network Management Protocol) is a protocol from the IP protocol family for transporting management information about network components.

Every SNMP management system contains an MIB. SNMP can be used to configure, control and administrate various network components from one system. Such an SNMP tool is included on your device: the Configuration Manager. As SNMP is a standard protocol, you can use any other SNMP managers, e.g. HPOpenView.

For more information on the SNMP versions, see the relevant RFCs and drafts:

- SNMP V. 1: RFC 1157
- SNMP V. 2c: RFC 1901 - 1908
- SNMP V. 3: RFC 3410 - 3418

16.4.1 SNMP Trap Options

In the event of errors, a message - known as a trap packet - is sent unrequested to monitor the system.

In the **External Reporting -> SNMP -> SNMP Trap Options** menu, you can configure the sending of traps.

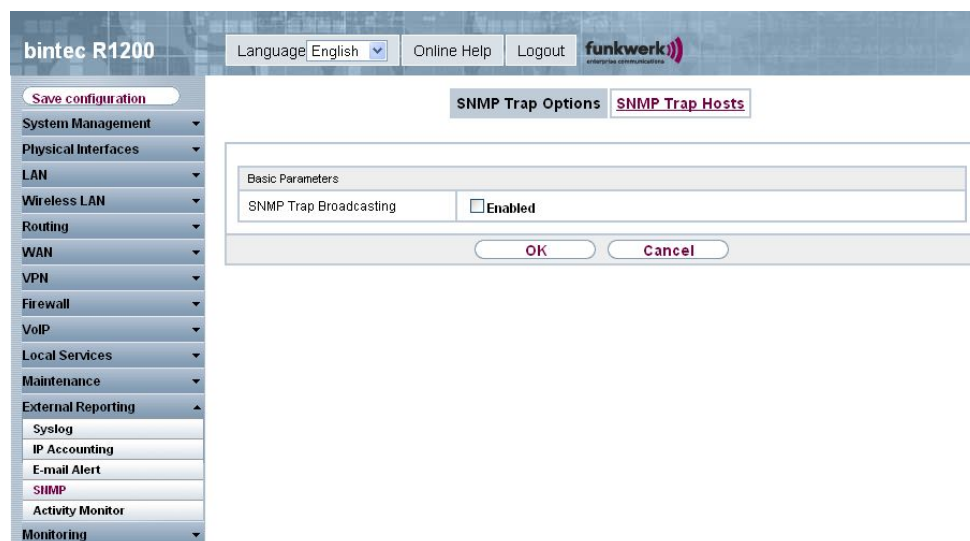

Fig. 204: External Reporting -> SNMP-> SNMP Trap Options

The **External Reporting** -> **SNMP** -> **SNMP Trap Options** menu consists of the following fields:

Fields in the SNMP Trap Options Basic Parameters menu

Field	Description
SNMP Trap Broadcasting	<p>Select whether the transfer of SNMP traps is to be activated.</p> <p>Your device then sends SNMP traps to the LAN's broadcast address.</p> <p>The function is activated by choosing <i>Enabled</i>.</p> <p>The function is disabled by default.</p>
SNMP Trap UDP Port	<p>Only if SNMP Trap Broadcasting is enabled.</p> <p>Enter the number of the UDP port to which your device is to send SNMP traps.</p> <p>Any whole number is possible.</p> <p>The default value is <i>162</i>.</p>
SNMP Trap Community	<p>Only if SNMP Trap Broadcasting is enabled.</p> <p>Enter a new SNMP code. This must be sent by the SNMP Manager with every SNMP request so that this is accepted by your device.</p> <p>A character string of between <i>0</i> and <i>255</i> characters is possible here.</p> <p>The default value is <i>snmp-Trap</i>.</p>

16.4.2 SNMP Trap Hosts

In this menu, you specify the IP addresses to which your device is to send the SNMP traps.

In the **External Reporting** -> **SNMP** -> **SNMP Trap Hosts** menu, a list of all configured SNMP trap hosts is shown.

16.4.2.1 New

Choose the **New** button to set up new SNMP trap hosts.

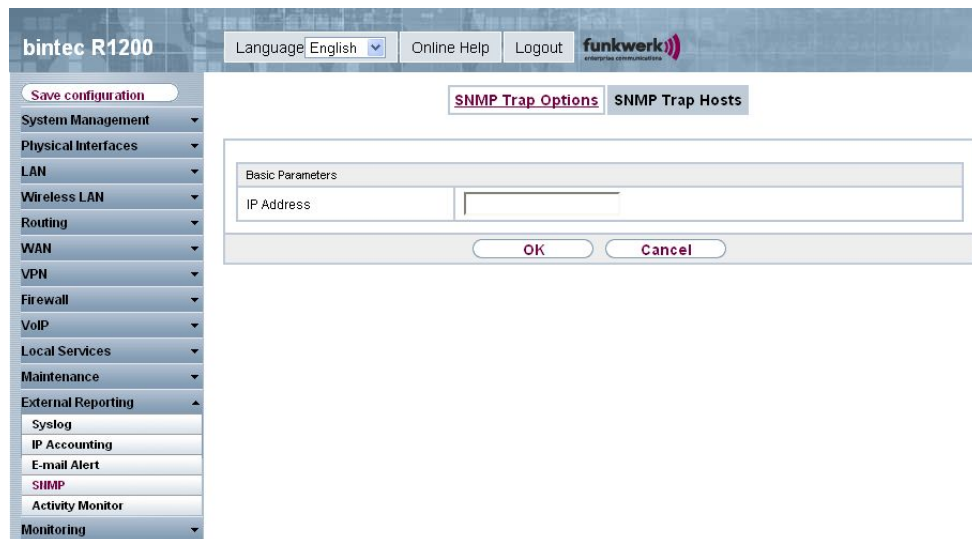

Fig. 205: External Reporting -> SNMP-> SNMP Trap Hosts -> New

The **External Reporting -> SNMP -> SNMP Trap Hosts -> New** menu consists of the following fields:

Fields in the SNMP Trap Hosts Basic Parameters menu

Field	Description
IP Address	Enter the IP address of the SNMP trap host.

16.5 Activity Monitor

This menu contains the settings needed to monitor your device with the Windows tool **Activity Monitor** (part of **BRICKware for Windows**).

Purpose

The **Activity Monitor** enables Windows users to monitor the activities of your device. Important information about the status of physical interfaces (e.g. ISDN line) and virtual interfaces is easily obtained with one tool. A permanent overview of the utilisation of your device is possible.

Method of operation

A Status Daemon collects information about your device and transfers it as UDP packets to

the broadcast address of the first LAN interface (default setting) or to an explicitly entered IP address. One packet is sent per time interval, which can be adjusted individually to values from 1 - 60 seconds. Up to 100 physical and virtual interfaces can be monitored, provided the packet size of 4096 bytes is not exceeded. The **Activity Monitor** on your PC receives the packets and can display the information contained in them in various ways according to the configuration.

Activate the **Activity Monitor** as follows:

- configure the relevant device(s) to be monitored.
- Start and configure the Windows application on your PC (see **BRICKware for Windows**).

16.5.1 Options

The screenshot shows the web interface for a bintec R1200 device. The top navigation bar includes 'Language English', 'Online Help', 'Logout', and the 'funkwerk' logo. The left sidebar lists various configuration categories, with 'External Reporting' expanded to show 'Activity Monitor'. The main content area is titled 'Options' and contains a 'Basic Parameters' section with the following fields:

- Monitored Interfaces:** Radio buttons for None, Physical, and Physical/WAN/VPN.
- Send information to:** A dropdown menu set to 'All IP Addresses (Broadcast)'. Other options include 'All IP Addresses (Unicast)' and 'Selected IP Addresses'.
- Update Interval:** A text input field containing '5' followed by the label 'Seconds'.
- UDP Destination Port:** A text input field containing '2107'.
- Password:** A text input field with masked characters (dots).

At the bottom of the configuration area are 'OK' and 'Cancel' buttons.

Fig. 206: **External Reporting -> Activity Monitor-> Options**

The **External Reporting -> Activity Monitor-> Options** menu consists of the following fields:

Fields in the Options Basic Parameters menu

Field	Description
Monitored interfaces	Select the type of information to be sent in the UDP packets to the Windows application. Possible values:

Field	Description
	<ul style="list-style-type: none"> • <i>Off</i> (default value) Deactivates the sending of information to the Activity Monitor. • <i>Physical</i>: Only information about the physical interfaces is sent. • <i>Physical/WAN/VPN</i>: Information about physical and virtual interfaces is sent
Send Information to	<p>Select where your device sends the UDP packets.</p> <p>Possible values:</p> <ul style="list-style-type: none"> • <i>All IP Addresses (broadcast)</i> (default value): The default value <i>255.255.255.255</i> means that the broadcast address of the first LAN interface is used. • <i>Single Host</i>: The UDP packets are sent to the IP address entered in the adjacent input field.
Update Interval	<p>Enter the update interval (in seconds).</p> <p>Possible values are <i>0</i> to <i>60</i>.</p> <p>The default value is <i>5</i>.</p>
UDP Destination Port	<p>Enter the port number for the Windows application Activity Monitor.</p> <p>The default value is <i>2107</i> (registered by IANA - Internet Assigned Numbers Authority).</p>
Password	<p>Enter the password for the Activity Monitor.</p>

Chapter 17 Monitoring

This menu includes information that enable you to locate problems in your network and monitor activities, e.g. at your device's WAN interface.

17.1 Internal Log

17.1.1 System messages

In the **Monitoring -> Internal Log -> System Messages** menu, a list of all internally stored system messages is shown. Above the table you will find the configured **Maximum Number of Syslog Entries** and the configured **Maximum Message Level of Syslog Entries**. These values can be changed in the **System Management -> Global Settings -> System** menu.

bintec R1200 Language English Online Help Logout 

Save configuration

System Management
Physical Interfaces
LAN
Wireless LAN
Routing
WAN
VPN
Firewall
VoIP
Local Services
Maintenance
External Reporting
Monitoring
Internal Log
IPSec
ISDIUModem
Interfaces
WLAN

System Messages

Automatic Refresh Interval 300 Seconds

Maximum Number of Syslog Entries 50

Maximum Message Level of Syslog Entries Information

View 20 per page Filter in None equal

#	Date	Time	Level	Subsystem	Message
1	2005-02-05	01:57:13	Information	INET	APDISCD: 3 access points found on interface 1000
2	2005-02-05	01:57:03	Information	INET	APDISCD: discovery initiated on interface 1000
3	2005-02-05	01:43:31	Alert	Configuration	NCI Alert: context.cpp-866: NCI-Page can not be found
4	2005-02-05	01:43:31	Alert	Configuration	NCI Alert: context.cpp-1043: Can not find
5	2005-02-05	01:42:43	Error	TTY	UMTS Ctl urmtsctl_open0: can't open urmts device!
6	2005-02-05	01:42:42	Error	TTY	Modem answer to <AT+CPIN?> is 'SIM busy'
7	2005-02-05	01:42:42	Information	IPSec	init: starting...
8	2005-02-05	01:42:42	Information	IPSec	BinTec ipsecd version 3.0 Copyright (c) 1996-2008 by Funkwerk Enterprise Communications GmbH
9	2005-02-05	01:42:42	Information	IPSec	init: running
10	2005-02-05	01:42:42	Information	INET	sshd: pid 56 - listening on 0.0.0.0 port 22.
11	2005-02-05	01:42:41	Information	Configuration	system r1200 started at Sat Feb 5 1:42:41 2005
12	2005-02-05	01:42:41	Information	USB	usb6-0-2: Sierra Wireless, Incorporated AirCard, rev 1.10/0.02
13	2005-02-05	01:42:38	Debug	USB	usb_create_dev: new unit addr 1, rev 100, class 9
14	2005-02-05	01:42:38	Debug	USB	subclass 0, proto 0, maxpkt 64, speed 2
15	2005-02-05	01:42:38	Debug	USB	usb_d_create_dev: setting device address=1
16	2005-02-05	01:42:38	Information	USB	usb6-0-1: NEC OHCI root hub, class 9/0, rev 1.00/1.00
17	2005-02-05	01:42:38	Information	USB	usb6-0-1: HUB with 1 port (1 removable), self-powered
18	2005-02-05	01:42:38	Debug	USB	usb_d_trap: rowno 1 - ev 0xffff
19	2005-02-05	01:42:38	Debug	USB	USB6-1-1: port=0 depth=0 (full-speed)
20	2005-02-05	01:42:38	Debug	USB	usb_create_dev: new unit addr 1, rev 100, class 9

Page: 1, Items: 1 - 20 , total items: 28

Fig. 207: Monitoring -> Internal Log->System Messages

Values in the list System Messages

Field	Description
#	Displays the serial number of the system message.
Date	Displays the date of the record.
Time	Displays the time of the record.
Level	Displays the hierarchy level of the message.
Subsystem	Displays which subsystem of the device generated the message.
Message	Displays the message text.

17.2 IPSec

17.2.1 IPSec Tunnels



In the **Monitoring -> IPSec -> IPSec Tunnel** menu, a list of all configured IPSec peers is shown.

The screenshot shows the web interface for a bintec R1200 device. The left sidebar contains a navigation menu with categories like System Management, Physical Interfaces, LAN, Wireless LAN, Routing, WAN, VPN, Firewall, VoIP, Local Services, Maintenance, External Reporting, and Monitoring. The Monitoring section is expanded, showing options for Internal Log, IPSec, ISDN/Modem, Interfaces, and WLAN. The main content area is titled 'IPSec Tunnels' and includes a table with the following columns: #, Description, Remote IP, Remote Networks, Security Algorithm, Status, and Action. The Status column contains up and down arrow icons. The table is currently empty, and the page indicates 'Page: 1'.

Fig. 208: **Monitoring -> IPSec -> IPSec Tunnel**

Values in the list IPSec Tunnels

Field	Description
#	Displays the serial number of the IPSec connection.
Description	Displays the name of the IPSec connection.
Remote IP Address	Displays the IP address of the remote IPSec peer.
Remote Networks	Displays the currently negotiated subnets of the remote terminal.
Security Algorithm	Displays the encryption algorithm of the IPSec connection.
Status	Displays the operating state of the IPSec connection.
Action	Enables you to change the status of the IPSec connection as displayed.
Details	Opens a detailed statistics window.

You change the status of the IPSec tunnel by pressing the  button or  button in the **Action** column.

By pressing the  button, you display detailed statistics on the IPsec connection.

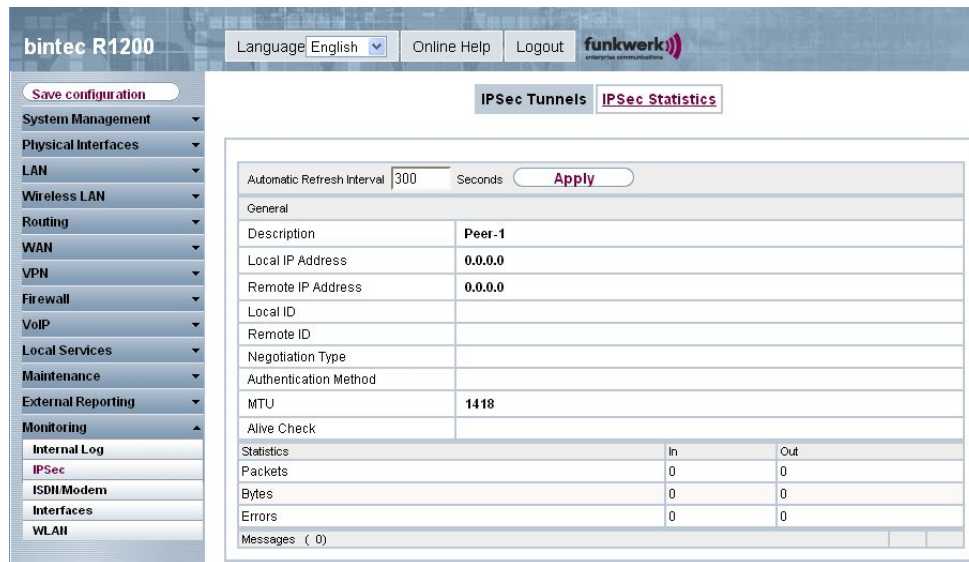

The screenshot shows the bintec R1200 web interface. The left sidebar contains a navigation menu with categories like System Management, Physical Interfaces, LAN, Wireless LAN, Routing, WAN, VPN, Firewall, VoIP, Local Services, Maintenance, External Reporting, and Monitoring. The Monitoring section is expanded, showing options for Internal Log, IPsec, ISDN Modem, Interfaces, and WLAN. The main content area displays the IPsec Tunnels configuration page, with the IPsec Statistics tab selected. At the top, there is a language dropdown set to English, an Online Help link, a Logout button, and the Funkwerk logo. Below this, there are tabs for IPsec Tunnels and IPsec Statistics. A form for Automatic Refresh Interval is set to 300 seconds with an Apply button. The main table shows the following details for a tunnel named Peer-1:

General		
Description	Peer-1	
Local IP Address	0.0.0.0	
Remote IP Address	0.0.0.0	
Local ID		
Remote ID		
Negotiation Type		
Authentication Method		
MTU	1418	
Alive Check		
Statistics		
	In	Out
Packets	0	0
Bytes	0	0
Errors	0	0
Messages (0)		

Fig. 209: Monitoring -> IPsec ->IPsec Tunnel->

Values in the list IPsec Tunnels

Field	Description
Description	The description of the peer is displayed here.
Local IP Address	The WAN IP address of your device is entered here.
Remote IP Address	The WAN IP address of the connection partner is entered here.
Local ID	The ID of your device for this IPsec connection is displayed here.
Remote ID	The peer ID is displayed here.
Negotiation Type	The exchange type is entered here.
Authentication Method	The authentication method is displayed here.
MTU	The current MTU (Maximum Transfer Unit) is displayed here.
Alive Check	The alive check method is displayed here.
Statistics (Packets, Bytes, Errors)	The parameters of the IKE (Phase 1) SAs are displayed here.
Messages	The system messages for this IPsec tunnel are displayed here.

17.2.2 IPSec Statistics

In the **Monitoring -> IPSec -> IPSec Statistics** menu, statistical values for all IPSec connections are shown.

The screenshot shows the bintec R1200 web interface. The left sidebar contains a navigation menu with categories like System Management, Physical Interfaces, LAN, Wireless LAN, Routing, WAN, VPN, Firewall, VoIP, Local Services, Maintenance, External Reporting, and Monitoring. The Monitoring section is expanded, showing options for Internal Log, IPSec, ISDN Modem, Interfaces, and WLAN. The main content area displays the 'IPSec Statistics' page. At the top, there is a 'Save configuration' button and a 'Language English' dropdown. Below that, there are 'Online Help' and 'Logout' links, and the 'funkwerk' logo. The main content area has a title bar with 'IPSec Tunnels' and 'IPSec Statistics' tabs. Below the title bar, there is an 'Automatic Refresh Interval' set to 300 seconds and an 'Apply' button. The main content area contains a table with the following data:

Licences		In Use	Maximum			
IPSec Tunnels		0	110			
Peers		Up	Going up	Blocked	Dormant	Configured
Status	0	0	0	1	1	
SAs		Established	Total			
IKE (Phase-1)		0	0			
IPSec (Phase-2)		0	0			
Packet Statistics		In	Out			
Total	137	294				
Passed	137	294				
Dropped	0	0				
Encrypted	0	0				
Errors	0	0				

Fig. 210: **Monitoring -> IPSec -> IPSec Statistics**

The **Monitoring -> IPSec -> IPSec Statistics** menu consists of the following fields:

Field in the menu IPSec Statistics Licenses

Field	Description
IPSec Tunnels	Shows the IPSec licenses currently in use (In use) and the maximum number of licenses usable (Maximum).

Field in the IPSec Statistics Peers menu

Field	Description
Status	Displays the number of IPSec connections by their current status. <ul style="list-style-type: none"> • Up: Currently active IPSec connections. • Going up: IPSec connections currently in the tunnel setup phase. • Blocked: IPSec connections that are blocked. • Dormant: Currently inactive IPSec connections.

Field	Description
	<ul style="list-style-type: none"> • Configured: Configured IPsec connections.

Field in the IPsec Statistics SAs menu

Field	Description
IKE (Phase1)	Shows the number of active phase 1 SAs (Established) from the total number of phase 1 SAs (Total).
IPsec (Phase2)	Shows the number of active phase 2 SAs (Established) from the total number of phase 2 SAs (Total).

Field in the IPsec Statistics Packet Statistics menu

Field	Description
Total	Shows the number of all processed incoming (Incoming) or outgoing (Outgoing) packets.
Passed	Shows the number of incoming (Incoming) or outgoing (Outgoing) packets forwarded in plain text.
Dropped	Shows the number of rejected incoming (Incoming) or outgoing (Outgoing) packets.
Encrypted	Shows the number of IPsec protected incoming (Incoming) or outgoing (Outgoing) packets.
Error	Shows the number of incoming (Incoming) or outgoing (Outgoing) packets for which the processing led to errors.

17.3 ISDN/Modem

17.3.1 Current Calls

In the **Monitoring** -> **ISDN/Modem** -> **Current Calls** menu, a list of the existing ISDN connections (incoming and outgoing) is shown.

The screenshot shows the 'bintec R1200' web interface. The top navigation bar includes 'Language English', 'Online Help', 'Logout', and the 'funkwerk' logo. A left sidebar contains a menu with categories like 'System Management', 'Physical Interfaces', 'LAN', 'Wireless LAN', 'Routing', 'WAN', 'VPN', 'Firewall', 'VoIP', 'Local Services', 'Maintenance', 'External Reporting', and 'Monitoring'. The 'Monitoring' section is expanded to show 'Internal Log', 'IPSec', 'ISDN/Modem', 'Interfaces', and 'WLAN'. The main content area is titled 'Current Calls' and features a table with the following columns: #, Service, Remote Number, Interface, Direction, Charge, Duration, Stack, Channel, and Status. Above the table, there are controls for 'Automatic Refresh Interval' (set to 300 seconds) and 'View' (set to 20 per page). A 'Go' button is present next to the table header. The page indicates 'Page: 1'.

Fig. 211: Monitoring -> ISDN/Modem ->Current Calls

Values in the list Current Calls

Field	Description
#	Displays the serial number of the ISDN connection entry.
Service	Displays the service to or from which the call is connected: <i>PPP, IPSEC, X.25, POTS</i> .
Remote Number	Displays the number that was dialed (in the case of outgoing calls) or from which the call was made (in the case of incoming calls).
Interface	Displays additional information for PPP connections.
Direction	Displays the send direction: <i>Incoming, Outgoing</i> .
Charge	Displays the costs of the current connection.
Duration	Displays the duration of the current connection.
Stack	Displays the related ISDN port (STACK).
Channel	Displays the number of the ISDN B channel.
Status	Displays the state of the connection: <i>null, c-initiated, ovl-send, oc-procd, c-deliverd, c-present, c-recvd, ic-procd, up, discon-req, discon-ind, suspd-req, re-sum-req, ovl-recv</i> .

17.3.2 Call History

In the **Monitoring -> ISDN/Modem -> Call History** menu, a list of the last 20 ISDN connections (incoming and outgoing) made since the last system boot is shown.

The screenshot shows the web interface for a bintec R1200 device. The top navigation bar includes 'Language English', 'Online Help', 'Logout', and the 'funkwerk' logo. A left-hand menu lists various system management options, with 'Monitoring' expanded to show 'Internal Log', 'IPSec', 'ISDN/Modem', 'Interfaces', and 'WLAN'. The 'ISDN/Modem' section is active, displaying 'Current Calls' and 'Call History' tabs. The 'Call History' tab is selected, showing a table with columns: #, Service, Remote Number, Interface, Direction, Charge, Start Time, and Duration. Above the table, there are controls for 'Automatic Refresh Interval' (300 seconds) and 'View' (20 per page). The table content is currently empty, with 'Page: 1' indicated at the bottom left of the table area.

Fig. 212: **Monitoring -> ISDN/Modem ->Call History**

Values in the list Call History

Field	Description
#	Displays the serial number of the ISDN connection.
Service	Displays the service to or from which the call was connected: <i>PPP, IPSEC, X.25, POTS.</i>
Remote Number	Displays the number that was dialed (in the case of outgoing calls) or from which the call was made (in the case of incoming calls).
Interface	Displays additional information for PPP connections.
Direction	Displays the send direction: <i>Incoming, Outgoing.</i>
Charge	Displays the costs of the connection.
Start Time	Displays the time at which the call was made or received.
Duration	Displays the duration of the connection.

17.4 Interfaces



174.1 Statistics

In the **Monitoring -> Interfaces -> Statistics** menu, the current values and activities of all device interfaces are shown.

The screenshot shows the 'bintec R1200' web interface. The top navigation bar includes 'Language English', 'Online Help', 'Logout', and the 'funkwerk' logo. A left sidebar menu lists various system management options, with 'Monitoring' expanded to show 'Internal Log', 'IPSec', 'ISDN Modem', 'Interfaces', and 'WAN'. The main content area is titled 'Statistics' and features a table of interface statistics. The table has columns for interface ID, description, type, and various traffic metrics (Tx/Rx Packets, Bytes, Errors). It also includes a 'Status' column with green/red indicators and an 'Action' column with up/down arrows and a magnifying glass icon. The table shows three entries: 'en1-0' (Ethernet) with 2.68K Tx Packets and 2.21M Tx Bytes; 'en1-4' (Ethernet) with 0 Tx/Rx Packets and Bytes; and 'Peer-1' (Tunnel) with 0 Tx/Rx Packets and Bytes. The 'Status' for 'en1-0' is green, while 'en1-4' and 'Peer-1' are red. The 'Action' column contains icons for up/down arrows and a magnifying glass.

#	Description	Type	Tx Packets	Tx Bytes	Tx Errors	Rx Packets	Rx Bytes	Rx Errors	Status	Unchanged for	Action
1	en1-0	Ethernet	2.68K	2.21M	0	2.33K	313.11K	0	🟢	0d 1h 49m 10s	⬆️⬆️ 🔍
2	en1-4	Ethernet	0	0	0	0	0	0	🔴	0d 1h 49m 12s	⬆️⬆️ 🔍
3	Peer-1	Tunnel	0	0	0	0	0	0	🔴	0d 0h 11m 41s	⬆️⬆️ 🔍

Fig. 213: **Monitoring -> Interfaces -> Statistics**

You change the state of the interface by pressing the  button or  button in the **Action** column. Press the  button to display the statistical data for the individual interfaces in detail.

Values in the list Statistics

Field	Description
#	Shows the serial number of the interface.
Description	Displays the name of the interface.
Type	Displays the interface text.
Tx Packets	Shows the total number of packets sent.
Tx Bytes	Displays the total number of octets sent.
Tx Errors	Shows the total number of errors sent.
Rx Packets	Shows the total number of packets received.
Rx Bytes	Displays the total number of bytes received.
Rx Errors	Shows the total number of errors received.
Status	Shows the operating status of the selected interface.

Field	Description
Unchanged for	Displays the length of time for which the operating state of the interface has not changed.
Action	Enables you to change the status of the interface as displayed.

17.5 WLAN

17.5.1 WLAN1

In the **Monitoring** -> **WLAN** -> **WLAN1** menu, the current values and activities of the first interface are shown.

The screenshot shows the web interface for a bintec R1200 device. The top navigation bar includes 'Language English', 'Online Help', 'Logout', and the 'funkwerk' logo. The left sidebar contains a menu with categories like 'System Management', 'Physical Interfaces', 'LAN', 'Wireless LAN', 'Routing', 'WAN', 'VPN', 'Firewall', 'VoIP', 'Local Services', 'Maintenance', 'External Reporting', and 'Monitoring'. Under 'Monitoring', 'WLAN1' is selected. The main content area shows 'WLAN1 VSS Client Links' and a table with columns for 'Automatic Refresh Interval' (300 Seconds), 'Apply', and 'WLAN1 Statistics'. The statistics table has three columns: 'mbps', 'Tx Packets', and 'Rx Packets'. The data rows show values for various data rates from 54 to 1 Mbps, with all packet counts currently at 0. A 'Total' row is also present. An 'Advanced' button is located at the bottom of the table.

mbps	Tx Packets	Rx Packets
54	0	0
48	0	0
36	0	0
24	0	0
18	0	0
12	0	0
11	0	0
9	0	0
6	0	0
5.5	0	0
2	0	0
1	0	0
Total	0	0

Fig. 214: Monitoring -> WLAN -> WLAN1

Values in the list WLAN1

Field	Description
Mbps	Displays the possible data rates on this radio module.
Tx Packets	Shows the total number of packets sent for the data rate shown in Mbps .
Rx Packets	Shows the total number of packets received for the data rate shown in Mbps .

You can choose the **Advanced** button to go to an overview of more details.

The screenshot shows the bintec R1200 web interface. The top bar includes 'Language English', 'Online Help', and 'Logout' buttons. The left navigation menu is expanded to 'Monitoring', with sub-items: 'Internal Log', 'IPSec', 'ISDN Modem', 'Interfaces', and 'WLAN'. The main content area shows the 'WLAN1' configuration page. At the top of this page, there are buttons for 'WLAN1', 'VSS', and 'Client Links'. Below these is a table with the following data:

#	Description	Value
1	Unicast MSDUs transmitted successfully	0
2	Multicast MSDUs transmitted successfully	0
3	Transmitted MPDUs	0
4	Multicast MSDUs received successfully	0
5	Unicast MPDUs received successfully	0
6	MSDUs that could not be transmitted	0
7	Frame transmissions without ACK received	0
8	Duplicate received MSDUs	0
9	CTS frames received in response to an RTS	0
10	Received MPDUs that couldn't be decrypted	0
11	RTS frames with no CTS received	0
12	Corrupt Frames Received	0

Below the table is a 'Back' button. Above the table, there is a control for 'Automatic Refresh Interval' set to '300' seconds, with an 'Apply' button.

Fig. 215: Monitoring -> WLAN -> WLAN1 -> Advanced

Values in the list Advanced

Field	Description
#	Displays the serial number of the list entry.
Description	Displays the description of the displayed value.
Value	Displays the statistical value.

Meaning of the list entries

Description	Meaning
Unicast MSDUs transmitted successfully	Displays the number of MSDUs successfully sent to unicast addresses since the last reset. An acknowledgement was received for each of these packets.
Multicast MSDUs transmitted successfully	Displays the number of MSDUs successfully sent to multicast addresses (including the broadcast MAC address).
Transmitted MPDUs	Displays the number of MPDUs received successfully.
Multicast MSDUs received successfully	Displays the number of successfully received MSDUs that were sent with a multicast address.
Unicast MPDUs received successfully	Displays the number of successfully received MSDUs that were sent with a unicast address.
MSDUs that could not be transmitted	Displays the number of MSDUs that could not be sent.
Frame transmissions	Displays the number of sent frames which which an acknow-

Description	Meaning
without ACK received	ledgement frame was not received.
Duplicate received MSDUs	Displays the number of MSDUs received in duplicate.
CTS frames received in response to an RTS	Displays the number of received CTS (clear to send) frames that were received as a response to RTS (request to send).
Received MPDU that couldn't be decrypted	Displays the number of received MSDUs that could not be encrypted. One reason for this could be that a suitable key was not entered.
RTS frames with no CTS received	Displays the number of RTS frames for which no CTS was received.
Invalid packets received	Displays the number of frames received incompletely or with errors.

17.5.2 VSS

In the **Monitoring -> WLAN -> VSS** menu, the current values and activities of the configured wireless networks are shown.

The screenshot shows the web interface for a bintec R1200 device. The top navigation bar includes 'Language English', 'Online Help', 'Logout', and the 'funkwerk' logo. A sidebar on the left contains a menu with categories like 'System Management', 'Physical Interfaces', 'LAN', 'Wireless LAN', 'Routing', 'WAN', 'VPN', 'Firewall', 'VoIP', 'Local Services', 'Maintenance', 'External Reporting', and 'Monitoring'. Under 'Monitoring', 'WLAN' is selected, and 'VSS' is highlighted. The main content area shows a table with the following data:

MAC Address	IP Address	Up Time	Tx Packets	Rx Packets	Signal dBm	Noise dBm	Data Rate mbps
00:0c:84:02:a9:8b	0.0.0.0	0 Day(s) 0:0:4	0	0	0	0	0

Fig. 216: Monitoring -> WLAN -> VSS

Values in the list VSS

Field	Description
MAC Address	Shows the MAC address of the associated client.

Field	Description
IP Address	Shows the IP address of the client.
Uptime	Shows the time in hours, minutes and seconds for which the client is logged in.
Tx Packets	Shows the total number of packets sent.
Rx Packets	Shows the total number of packets received.
Signal dBm	Shows the received signal strength in dBm.
Noise dBm	Shows the received noise strength in dBm.
Data rate Mbit/s	<p>Shows the current transmission rate of data received by this client in Mbit/s.</p> <p>The following transmission rates are possible: IEEE 802.11b: 11, 5.5, 2 and 1 Mbit/s; IEEE 802.11g/a: 54, 48, 36, 24, 18, 12, 9, 6 Mbit/s.</p> <p>If the 5 GHz frequency band is used, the indication of 11, 5.5, 2 and 1 Mbit/s is suppressed for IEEE 802.11b.</p>

VSS - Details for Connected Clients

In the **Monitoring** -> **WLAN** -> **VSS**-><Connected client>->  menu, the current values and activities of a connected client are shown.

bintec R1200

Language English Online Help Logout 

[Save configuration](#)

[WLAN1](#) [VSS](#) [WDS](#) [Client Links](#)

Automatic Refresh Interval 60 Seconds [Apply](#)

Client MAC Address	IP Address	Up Time	Signal dBm	Noise dBm	SNR dB	Data Rate mbps
00:0c:84:02:a9:8b	0.0.0.0	0 Day(s) 0:1:59	0	0	0	0
Rate	Tx Packets		Rx Packets			
54	0		0			
48	0		0			
36	0		0			
24	0		0			
18	0		0			
12	0		0			
11	0		0			
9	0		0			
6	0		0			
5.5	0		0			
2	0		0			
1	0		0			
Total	0		0			

[Back](#)

Fig. 217: Monitoring -> WLAN -> VSS-><Connected client>->

Values in the list VSS <Connected client>

Field	Description
Client MAC Address	Shows the MAC address of the associated client.
IP Address	Shows the IP address of the client.
Uptime	Shows the time in hours, minutes and seconds for which the client is logged in.
Signal dBm	Shows the received signal strength in dBm.
Noise dBm	Shows the received noise strength in dBm.
SNR dB	<p>Signal-to-Noise Ratio in dB is an indicator of the quality of the wireless connection.</p> <p>Values:</p> <ul style="list-style-type: none"> • > 25 dB excellent • 15 - 25 dB good • 2 - 15 dB borderline • 0 - 2 dB bad.
Data rate Mbit/s	Shows the current transmission rate of data received by this client in Mbit/s. The following transmission rates are possible: IEEE 802.11b: 11, 5.5, 2 and 1 Mbit/s; IEEE 802.11g/a: 54, 48,

Field	Description
	36, 24, 18, 12, 9.6 Mbit/s. If the 5-GHz frequency band is used, the indication of 11, 5.5, 2 and 1 Mbit/s is suppressed for IEEE 802.11b.
Rate	Displays the possible data rates on this radio module.
Tx Packets	Shows the number of sent packets for the data rate.
Rx Packets	Shows the number of received packets for the data rate.

17.5.3 WDS

In the **Monitoring -> WLAN -> WDS** menu, the current values and activities of the configured WDS links are shown.

The screenshot shows the web interface for a bintec R1200 device. The left sidebar contains a navigation menu with categories like System Management, Physical Interfaces, LAN, Wireless LAN, Routing, WAN, VPN, Firewall, VoIP, Local Services, Maintenance, External Reporting, and Monitoring. The Monitoring section is expanded, showing sub-items: Internal Log, IPSec, ISDN Modem, Interfaces, and WLAN. The main content area displays the WDS configuration page. At the top, there are buttons for WLAN1, VSS, WDS, and Client Links. Below these is a section for 'Automatic Refresh Interval' set to 300 seconds with an 'Apply' button. The main part of the page is a table titled 'WDS Table' with the following data:

WDS Description	Remote MAC	Up Time	Tx Packets	Rx Packets	Signal dBm	Noise dBm	Data Rate mbps
wds1-0	00:00:00:00:00:00	0d 0h 31m 50s	0	0	0	0	0

Fig. 218: Monitoring -> WLAN -> WDS

Values in the list WDS

Field	Description
WDS description	Shows the name of the WDS link.
Remote MAC	Shows the MAC address of the WDS link partner.
Uptime	Shows the time in hours, minutes and seconds for which the WDS link in question is active.
Tx Packets	Shows the total number of packets sent.
Rx Packets	Shows the total number of packets received.

Field	Description
Signal dBm	Shows the received signal strength in dBm.
Noise dBm	Shows the received noise strength in dBm.
Data rate Mbit/s	Shows the current transmission rate of data received on this WDS link in Mbit/s.

If required, the **Test** link can be used to start a link test. The test is only available for **funkwerk** devices and only if the WDS link is active.

The link test provides all the data necessary for checking the quality of the WDS link. The link test also helps you to align the antennas. This option is only displayed if the link state is *Enabled*.

WDS Link Details

You use the  icon to open an overview of further details for the WDS links.

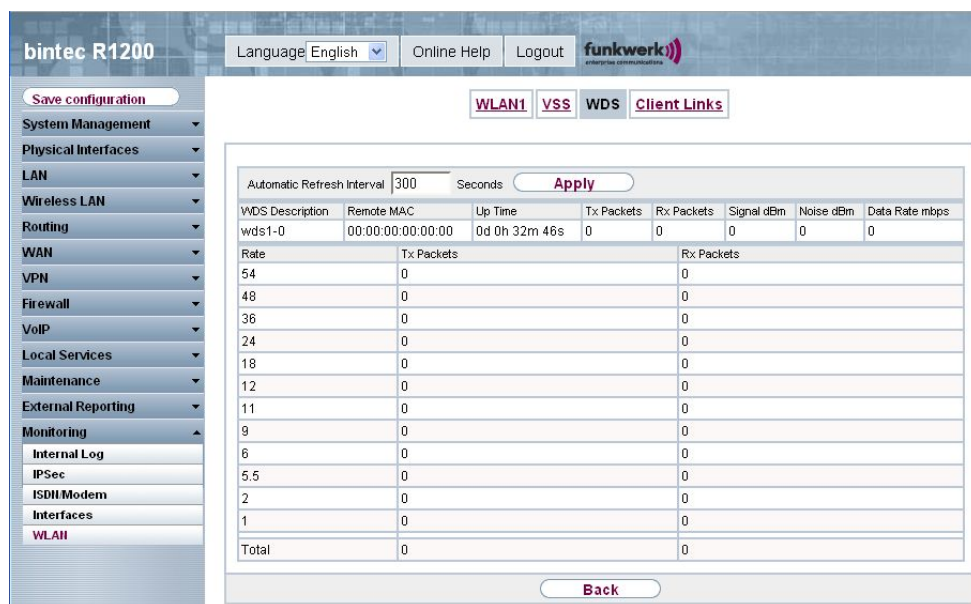

The screenshot shows the web interface for a bintec R1200 device. The top navigation bar includes 'Language English', 'Online Help', 'Logout', and the 'funkwerk' logo. A secondary navigation bar contains 'WLAN1', 'VSS', 'WDS', and 'Client Links'. The main content area features a table with the following data:

Automatic Refresh Interval 300 Seconds Apply							
WDS Description	Remote MAC	Up Time	Tx Packets	Rx Packets	Signal dBm	Noise dBm	Data Rate mbps
wds1-0	00:00:00:00:00:00	0d 0h 32m 46s	0	0	0	0	0
Rate			Tx Packets		Rx Packets		
54	0			0			
48	0			0			
36	0			0			
24	0			0			
18	0			0			
12	0			0			
11	0			0			
9	0			0			
6	0			0			
5,5	0			0			
2	0			0			
1	0			0			
Total	0			0			

At the bottom of the table area, there is a 'Back' button.

Fig. 219: Monitoring -> WLAN -> WDS->

Values in the list WDS

Field	Description
WDS description	Shows the name of the WDS link.
Remote MAC	Shows the MAC address of the WDS link partner.

Field	Description
Uptime	Shows the time in hours, minutes and seconds for which the WDS link in question is active.
Tx Packets	Shows the total number of packets sent.
Rx Packets	Shows the total number of packets received.
Signal dBm	Shows the received signal strength in dBm.
Noise dBm	Shows the received noise strength in dBm.
Data rate Mbit/s	Shows the current transmission rate of data received on this WDS link in Mbit/s.
Rate	Shows separately, for each of the stated data rates, the values for Tx Packets and Rx Packets .

17.5.4 Client Links

In the **Monitoring -> WLAN -> Client Links** menu, the current values and activities of the client links are shown.

The screenshot shows the web interface for a bintec R1200 device. The top navigation bar includes 'Language English', 'Online Help', 'Logout', and the 'funkwerk' logo. The left sidebar contains a menu with categories like System Management, Physical Interfaces, LAN, Wireless LAN, Routing, WAN, VPN, Firewall, VoIP, Local Services, Maintenance, External Reporting, and Monitoring. The 'Monitoring' menu is expanded, showing 'Internal Log', 'IPSec', 'ISDN Modem', 'Interfaces', and 'WLAN'. The 'WLAN' menu is further expanded to show 'WLAN1', 'VSS', 'WDS', and 'Client Links'. The 'Client Links' page displays an 'Automatic Refresh Interval' of 300 seconds and an 'Apply' button. Below this is a 'Client Link Table' with the following data:

Client Link Description	AP MAC Address	Up Time	Tx Packets	Rx Packets	Signal dBm	Noise dBm	Data Rate mbps
WLAN1 ()							
sta1-0		0d 0h 23m 17s	0	0	0	0	0

Fig. 220: Monitoring -> WLAN -> Client Links

Values in the Client Links list

Field	Description
Description of the client link	Shows the name of the client link.
AP MAC address	Shows the MAC address of the client link partner.

Field	Description
Uptime	Shows the time in hours, minutes and seconds for which the client link in question is active.
Tx Packets	Shows the total number of packets sent.
Rx Packets	Shows the total number of packets received.
Signal dBm	Shows the received signal strength in dBm.
Noise dBm	Shows the received noise strength in dBm.
Data rate Mbit/s	Shows the current transmission rate of data received on this client link in Mbit/s.

Client Link Details

You can use the  icon to open a summary of further details of the client links.

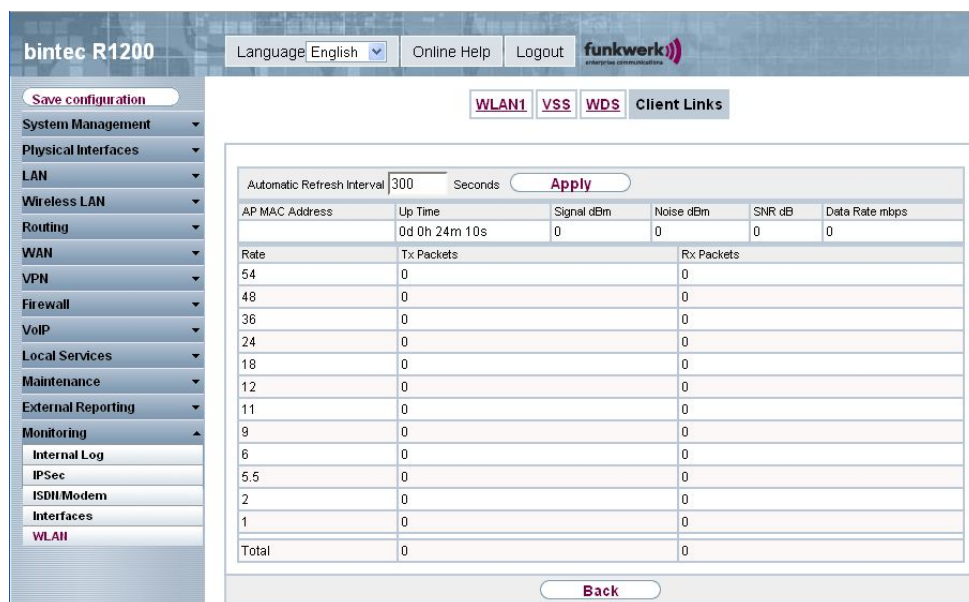

The screenshot shows the 'Client Links' monitoring page in the bintec R1200 web interface. The page features a navigation menu on the left with options like 'Save configuration', 'System Management', 'Physical Interfaces', 'LAN', 'Wireless LAN', 'Routing', 'WAN', 'VPN', 'Firewall', 'VoIP', 'Local Services', 'Maintenance', 'External Reporting', and 'Monitoring'. The main content area displays a table of client link details with the following columns: AP MAC Address, Uptime, Signal dBm, Noise dBm, SNR dB, and Data Rate mbps. The table shows a total of 0 for all metrics. A 'Back' button is located at the bottom of the table.

AP MAC Address	Uptime	Signal dBm	Noise dBm	SNR dB	Data Rate mbps
	0d 0h 24m 10s	0	0	0	0
Rate	Tx Packets		Rx Packets		
54	0		0		
48	0		0		
36	0		0		
24	0		0		
18	0		0		
12	0		0		
11	0		0		
9	0		0		
6	0		0		
5.5	0		0		
2	0		0		
1	0		0		
Total	0		0		

Fig. 221: Monitoring -> WLAN -> Client Links->

Values in the Client Links list

Field	Description
AP MAC address	Shows the MAC address of the client link partner.
Uptime	Shows the time in hours, minutes and seconds for which the client link in question is active.
Signal dBm	Shows the received signal strength in dBm.

Field	Description
Noise dBm	Shows the received noise strength in dBm.
SNR dB	Shows the signal quality in dB.
Data rate Mbit/s	Shows the current transmission rate of data received on this client link in Mbit/s.
Rate	Shows separately, for each of the stated data rates, the values for Tx Packets and Rx Packets .

Glossary

Announcement	If you want to call your employees or family members to a meeting or the dinner table, you could call each one of them individually or simply use the announcement function. With just one call, you reach all the announcement-enabled telephones without the subscribers having to pick up the receiver.
Announcement function	Performance feature of a PBX. On suitable telephones (e.g. system telephones), announcements can be made as on an intercom.
Bit	Binary digit. Smallest unit of information in computer technology. Signals are represented in the logical states "0" and "1".
Bundle	The external connections of larger PBXs can be grouped into bundles. When an external call is initiated by the exchange code or in the event of automatic external line access a bundle released for this subscriber is used to establish the connection. If a subscriber has authorisation for several bundles, the connection is established using the first released bundle. If one bundle is occupied, the next released bundle is used. If all the released bundles are occupied, the subscriber hears the engaged tone.
Busy On Busy	Call to engaged team subscriber. If one subscriber in a team has taken the receiver off the hook or is on the telephone, you can decide whether other calls are to be signalled for this team. The setting for reaching a subscriber can be toggled between "Standard" and "Busy On Busy". In the basic configuration, it is set to Standard. If Busy on Busy is set for a team, other callers hear the engaged tone.
DECT	Digital European Cordless Telecommunication. European standard for wireless telephones and wireless PBXs. Internal calls can be made free of charge between several handheld units. Another advantage is the higher degree of interception protection (GAP).
Digital exchange	Allows computer-controlled crossbar switches to set up a connection quickly, and special features such as inquiries, call waiting, three-party conference and call forwarding to be activated. All T-Com exchanges have been digital since January 1998.
Digital voice transmission	As a result of the internationally standardised Pulse Code Modulation (PCM), analogue voice signals are converted to a digital pulse flow of 64 kbps. Advantages: Better voice quality and less susceptibility to faults during analogue voice transmission.

Direct Call	You are not at home. However, there is someone at home who needs to be able to reach you quickly and easily by telephone if necessary (e.g. children or grandparents). As you can set up the Direct Call function for one or more telephones, the receiver of the telephone simply needs to be lifted. After five seconds, the PBX automatically calls the defined direct call number, if you do not start dialing another number first. You can enter up to 12 destination numbers when you configure Direct Call. A direct call number can only be used by one subscriber. If you want to change an entered direct call number, you can simply enter the new direct call number without having to delete the old direct call number. The old number is automatically overwritten when the new configuration is transferred to the PBX.
DISA	Direct Inward System Access
Download	Data transfer during online connections, where files are "loaded" from a PC or data network server to the user's own PC, PBX or terminal, so that they can be used there.
DSL and ISDN connections	Data is transferred between the Internet and your PBX over ISDN or T-DSL. The PBX determines the remote terminal to which a data packet is to be sent. For a connection to be selected and set up, parameters must be defined for all the required connections. These parameters are stored in lists which together permit the right connection to be set up. The PBX uses the PPP (Point-to-Point Protocol) for ISDN access, and PPPoE (Point-to-Point Protocol over Ethernet) for access over T-DSL. The traffic on these two Internet connections is monitored separately by the PBX.
DSL modem	Special modem for data transmission using DSL access technology.
DSL splitter	A DSL splitter is a device that splits the data or frequencies of various applications that run via a subscriber line or distribution point, and provides this via separate connections.
Services	Euro ISDN contains service indicators with defined names. Some of these have only historical meaning. In general, you should choose the "Telephony" service for "real" telephone calls. If this selection does not work (depends on network operator), you can try "speech", "audio 3k1Hz" or "telephony 3k1Hz". The same applies for faxing. Here, too, there is the collective term "Fax" plus a couple of more specific cases. From a purely technical point of view, the services are bits in a data word evaluated by means of a mask. If you include several bits in the mask, all these services are approved for activation, while in the case of just one bit, it is just the one selected ser-

vice.

Three-party conference	A three-way telephone call. Performance feature in T-Net, T-ISDN and your PBX.
10 Base 2	Thin Ethernet connection. Network connection for 10-mbps networks with BNC connector. T-connectors are used for the connection of equipment with BNC sockets.
100Base-T	Twisted pair connection, Fast Ethernet. Network connection for 100-mbps networks.
10Base-T	Twisted pair connection. Network connection for 10-mbps networks with RJ45 connector.
1TR6	D channel protocol used in the German ISDN. Today the more common protocol is DSS1.
3DES (Triple DES)	See DES.
802.11a/g	Specified data rates of 54, 48, 36, 24, 18, 12, 9 and 6 mbps and a working frequency in the range of 5 GHz (for IEEE802.11a) or 2.4 GHz (for IEEE802.11g). IEEE802.11 g can be configured to run in compliance with 11b or 11b and 11 as well.
802.11b/g	One of the IEEE standards for wireless network hardware. Products that meet the same IEEE standard can communicate with each other, even if they come from different hardware manufacturers. The IEEE802.11b standard specifies the data rates of 1, 2, 5.5 and 11 mbps, a working frequency in the range of 2.4 to 2.4835 GHz and WEP encryption. IEEE802.11 wireless networks are also known as Wi-Fi networks.
A-subscriber	The A-subscriber is the caller.
a/b interface	For connection of an analogue terminal. In the case of an ISDN terminal (terminal adapter) with a/b interface, the connected analogue terminal is able to use the supported T-ISDN performance features.
AAA	Authentication, Authorisation, Accounting
Access code	PIN or password
Access list	A rule that defines a set of packets that should or should not be transmitted by the device.
Access point	An active component of a network consisting of wireless parts and

optionally also of wired parts. Several WLAN clients (terminals) can log in to an access point (AP) and communicate via the AP data. If the optional wired Ethernet is connected, the signals between the two physical media, the wireless interface and wired interface, are bridged (bridging).

Access protection	Filters can be used to prevent external persons from accessing the data on the computers in your LAN. These filters are a basic function of a firewall.
Accounting	Recording of connection data, e.g. date, time, connection duration, charging information and number of data packets transferred.
Active probing	Active probing takes advantage of the fact that as standard, access points are to respond to client requests. Clients therefore send "probe requests" on all channels and wait for responses from an access point in the vicinity. The response packet then contains the SSID of the wireless LAN and information on whether WEP encryption is used.
Ad hoc network	An ad hoc network refers to a number of computers that form an independent 802.11 WLAN each with a wireless adapter. Ad hoc networks work independently without an access point on a peer-to-peer basis. Ad hoc mode is also known as IBSS mode (Independent Basic Service Set) and makes sense for the smallest networks, e.g. if two notebooks are to be linked to each other without an access point.
ADSL	Asymmetric digital subscriber line
AH	Authentication header
Alphanumeric display	Display unit e.g. for T-Concept PX722 system telephone, able to display letters and other characters as well as digits.
Analogue connections	For the connection of analogue terminals such as telephone, fax and answering machine.
Analogue terminals	Terminals that transmit voice and other information analogously, e.g. telephone, fax machine, answering machine and modem.
Analogue voice transmission	To transmit voice via the telephone, acoustic oscillations are converted to continuous electrical signals, which are transmitted via a network of lines (digital voice transmission).
Answering machine	You configure an analogue answering machine under "Terminal Type".

AOC-D	Display during and at end of connection.
AOC-D/E	Advice of charge-during/end.
AOC-E	Display only at end of connection.
ARP	Address Resolution Protocol
Assignment	An external call can be signalled to internal subscribers. The entries in the "Day" option and "Night" option can be different.
Asynchronous	A method of data transmission in which the time intervals between transmitted characters can vary in length. This allows computers and peripheral devices to intercommunicate without being synchronised by clock signals. The beginning and end of the transmitted characters must be marked by start and stop bits – in contrast to synchronous transmission.
ATM	Asynchronous transfer mode
Attention tone	Superimposing of an acoustic signal during a telephone call e.g. for call waiting.
Authentication	Check on the user's identify.
Authorisation	Based on the identity (authentication), the user can access certain services and resources.
Automatic callback	Special feature on telephones: By pressing a key or code, the caller requests a call back from the engaged terminal. If the subscriber you want is not at their desk or cannot take the call, they are automatically connected with the caller as soon as they have used the telephone again and replaced the receiver.
Automatic callback on busy	This function can only be used on telephones that permit suffix dialling. An automatic callback from an inquiry connection is not possible.
Automatic callback on busy (CCBS)	You urgently need to contact a business partner or internal subscriber. However, when you call, you always hear the engaged tone. If you were to receive notification that the subscriber had ended the call, your chance of reaching them would be very good. With "Call-back on Busy" you can reach the engaged subscriber once they have replaced the receiver at the end of the call. Your telephone rings. When you lift the receiver, a connection to the required subscriber is set up automatically. An internal "Callback on Busy" is deleted automatically after 30 minutes. The external "Callback on

Busy" is deleted after a period specified by the exchange (approx. 45 minutes). Manual deletion before this period has elapsed is also possible.

- Automatic callback on no reply (CCBS)** You urgently need to contact a business partner or internal subscriber. When you call them, you always hear the ringing tone, but your business partner is not close to the telephone and does not pick up. With "Callback on no reply", you can reach the subscriber as soon as they have completed a call or lifted and replaced the receiver of their telephone. Your telephone rings. When you lift the receiver, a connection to the required subscriber is established automatically.
- Automatic clearing of Internet connection (ShortHold)** You can activate ShortHold. When you do so, you define the time after which an existing connection is cleared if data transfer is no longer taking place. If you enter a time of 0, ShortHold is deactivated.
- Automatic outside line** After the receiver of a telephone is lifted, the telephone number of the external subscriber can be dialled immediately.
- Automatic redialling** Performance feature of a terminal. If the line is busy, several redial attempts are made.
- B channel** Corresponds to a telephone line in T-Net. In T-ISDN, the basic connection contains two B channels, each with a data transmission rate of 64 kbps.
- B channel** Bearer channel of an ISDN Basic Rate Interface or a Primary Rate Interface for the transmission of traffic (voice, data). An ISDN Basic Rate Interface consists of two B channels and one D channel. A B channel has a data transmission rate of 64 kbps. The data transmission rate of an ISDN Basic Rate Interface with your gateway can be increased to up to 128 kbps using channel bundling.
- BACP/BAP** Bandwidth Allocation Control Protocols (BACP/BAP in accordance with RFC 2125)
- Base station** Central unit of wireless telephone devices. There are two different types: The simple base station is used to charge the handheld unit. For special-feature telephones, the base station can also be used as a telephone, the handheld unit is charged using separate charging stations.
- Basic Rate Interface** ISDN connection that includes two basic channels (B channels) each with 64 kbps and one control and signalling channel (D chan-

nel) with 16 kbps. The two basic channels can be used independently of each other for each service offered in the T-ISDN. You can therefore telephone and fax at the same time. T-Com offers the Basic Rate Interface as a point-to-multipoint or point-to-point connection.

Blacklist (dialling ranges)

You can define a restriction on external dialling for individual subscribers. The telephone numbers entered in the blacklist table cannot be called by the terminals subject to dialling control, e.g. entry 0190 would block all connections to expensive service providers.

Block Cipher Modes Block-based encryption algorithm**Blowfish**

An algorithm developed by Bruce Schneier. It relates to a block cipher with a block size of 64 bit and a key of variable length (up to 448 bits).

Bluetooth

Bluetooth is a wireless transfer technology that can connect up different devices. Bluetooth replaces cables to connect various devices e.g. Notebook, PC, PDA, etc. Thanks to Bluetooth, these devices can exchange data with each other without a fixed connection. For example, PCs, notebooks or a PDA can access the Internet or a local network. The appointments on a PDA can be synchronised with the appointments on the PC without the need for a cable connection. Because of the many different application areas for the Bluetooth technology, the different types of connections between the devices are divided into profiles. A profile determines the service (function) that the individual Bluetooth clients can use among each other.

BOD

Bandwidth on Demand

BootP

Bootstrap protocol

Bps

Bits per second. A unit of measure for the transmission rate.

Break-in

In a PBX, the option of breaking in to an existing call. This is signalled acoustically by an attention tone.

BRI

Basic Rate Interface

Bridge

Network component for connecting homogeneous networks. As opposed to a gateway, bridges operate at layer 2 of the OSI model, are independent of higher-level protocols and transmit data packets using MAC addresses. Data transmission is transparent, which means the information contained in the data packets is not inter-

	preted.
Broadcast	Broadcasts (data packages) are sent to all devices in a network in order to exchange information. Generally, there is a certain address (broadcast address) in the network that allows all devices to interpret a message as a broadcast.
Brokering	Brokering makes it possible to switch between two external or internal subscribers without the waiting subscriber being able to hear the other conversation.
Browser	Program for displaying content on the Internet or World Wide Web.
Bus	A data transmission medium for use by all the devices connected to a network. Data is forwarded over the entire bus and received by all devices on the bus.
CA	Certificate Authority
Calendar	By allocating a calendar, you switch between Day and Night call assignment. For each day of the week, you can select any day/night switching time. A calendar has four switch times, which can be specifically assigned to each individual day of the week.
Call allocation	In a PBX, calls can be assigned to certain terminals.
Call costs account	You can set up a "call costs account" for a subscriber here. The maximum available number of units, in the form of a limit, can be assigned to each subscriber on their personal "call costs account". The "cost limit" is to be activated so that units can be booked. Once the units have been used up, no further external calls are possible. Internal calls can still be made at any time. The units are booked to the account each time a call is ended.
Call diversion	Also known as call forwarding. An incoming call is diverted to a specified telephone, Internet or wireless connection.
Call filter	Performance feature e.g. of the T-Concept PX722 system telephone, special-feature telephones or answering machines. The call is only signalled in the case of certain previously defined telephone numbers.
Call forwarding in the exchange	You can only use the options of call forwarding in the exchange via the keypad if certain services are activated for your connection. You can receive more information on this from your T-Com advisor. The exchange connects the calling subscriber with an external subscriber you have specified.

- Call forwarding in the PBX** The call forwarding (CF) performance feature of the PBX enables you to be reached even if you are not in the vicinity of your telephone. You achieve this by automatically forwarding your calls to the required internal or external telephone number. You can use the configuration program to define whether call forwarding should be carried out in the PBX or the exchange. You should use call forwarding in the exchange if certain services are activated for your connection. You can receive more information on this from your T-Com advisor.
- Call option day/night** Option of changing the call allocation on a PBX using a calendar. Calls received after office hours are forwarded to a telephone still manned, or to the answering machine or fax.
- Call pickup** Performance feature of a PBX. Calls can be received on an internal terminal that is not part of active call allocation.
- Call pickup** An external call is only signalled for your colleague. As you belong to several different teams, this is not surprising. You can now form various groups of subscribers in which call pickup is possible. A call can only be picked up by subscribers/terminals in the same pickup group. The assignment of subscribers in pickup groups is not dependent on the settings in the Day and Night team call assignment.
- Call Relay on Busy** Reject
- Call Through** Call Through is a dial-in via an external connection to the PBX with the call put through from the PBX via another external connection.
- Call to engaged subscriber** Busy on busy
- Call waiting** The "Call Waiting" performance feature means that other people can contact you during a telephone call. If another subscriber calls while you are on the telephone, you hear your telephone's call waiting tone. You can then decide whether to continue with your first call or speak to the person whose call is waiting.
- Call waiting protection** If you do not want to use the call waiting feature, you switch on call waiting protection. If you are taking a call, a second caller hears the engaged tone.
- Callback on Busy** Performance feature in T-ISDN, PBXs and T-Net. A connection is set up automatically as soon as the Busy status on the destination connection ends. When the connection is free, this is signalled to the caller. As soon as the caller lifts the receiver, the connection is

set up automatically. However, Callback must first be activated by the caller on his or her terminal.

Callback on no reply	You call a subscriber, who does not pick up. With "Callback on no reply", this is not a problem for you, because with this special feature, you can set up the connection without having to redial. If you are not on the telephone yourself, a new connection with the subscriber is set up - for a maximum of 180 minutes.
Called party number	Number of the terminal called.
Caller list	Special-feature telephones such as the T-Concept PX722 system telephone enable call requests to be stored during absence.
Calling party number	Number of the calling terminal.
CAPI	Common ISDN Application Programming Interface
CAST	A 128-bit encryption algorithm with similar functionality to DES. See Block Cipher Modes.
CBC	Cipher Block Chaining
CCITT	Consultative Committee for International Telegraphy and Telephony
CD (Call Deflection)	The forwarding of calls. This performance feature enables you to forward a call without having to take it yourself. If you forward a call to an external subscriber, you bear any connection costs from your connection to the destination of the forwarded call. This feature can therefore be used by system telephones and ISDN telephones that support this function (see user's guide for terminals). For more information on using this performance feature with the telephone, please see the user's guide.
Central speeddial memory	Performance feature of a PBX. Telephone numbers are stored in a PBX and can be called from every connected telephone using a key combination.
Certificate	Certificate
Channel Bundling	Channel bundling
CHAP	Challenge Handshake Authentication Protocol
Checksum field	Frame Check Sequence (FCS)
CLID	Calling Line Identification

Client	A client uses the services provided by a server. Clients are usually workstations.
CLIP	Abbreviation for Calling Line Identification Presentation. Telephone number display of calling party.
CLIR	Abbreviation for Calling Line Identification Restriction. Temporary suppression of the transmission of the calling party's telephone number.
COLR	Connected Line Identification Restriction (suppress B telephone number). This performance feature permits or suppresses the display of the called subscriber's telephone number. If display of the B telephone number is suppressed, your telephone number is not transmitted to the caller when you take a call. Example: You have set up call diversion to another terminal. If this terminal has activated suppression of the B telephone number, the calling party does not see a telephone number on the terminal display.
Combination device	If an analogue terminal connection of the PBX is set up as a "multi-functional port" for combination devices, all calls are received, regardless of the service. In the case of trunk prefixes using codes, the service ID "Analogue Telephony" or "Telefax Group 3" can also be transmitted, regardless of the configuration of the analogue connection. If 0 is dialled, the service ID "Analogue Telephony" is also transmitted.
Conference call	Performance feature of a PBX: Several internal subscribers can telephone simultaneously. Three-party conferences are also possible with external subscribers.
Configuration Manager	Windows application (similar to the Windows Explorer), which uses SNMP commands to request and carry out the settings of your gateway. The application was called the DIME Browser before BRICK-ware version 5.1.3.
Configuration of the PBX with the PC	One important prerequisite for the transfer of your configuration to the PBX is that you have set up a connection between the PC and PBX. You can do this using the LAN Ethernet connection.
Configuration of the PBX with the telephone	With some restrictions, you can also program your PBX using the telephone. For information on programming your PBX using the telephone, please see the accompanying user's guide.
Connection of analogue terminals	The performance features for analogue terminals can only be used with terminals that use the MFC dialling method and that have an R

or flash key.

Connection of ISDN terminals	The internal telephone number of the connection, and not the external number (multiple subscriber number) must be entered as the MSN in the ISDN terminal connected to the internal ISDN bus. See the user's guide for the ISDN terminals: Enter MSN. Please note that not all the ISDN terminals available on the market can use the performance features provided by the PBX via their key interface.
CRC	Cyclic Redundancy Check
CTI	Computer Telephony Integration. Term for connection between a PBX and server. CTI enables PBX functions to be controlled and evaluated by a PC.
D channel	Control and signalling channel of an ISDN Basic Rate Interface or Primary Rate Interface. The D channel has a data transmission rate of 16 kbps. In addition to the D channel, each ISDN BRI has two B channels.
Data compression	A process for reducing the amount of data transmitted. This enables higher throughput to be achieved in the same transmission time. Examples of this technique include STAC, VJHC and MPPC.
Data Link Layer	(DLL)
Data packet	A data packet is used for information transfer. Each data packet contains a prescribed number of characters (information and control characters).
Data transmission rate	The data transmission rate specifies the number of information units for each time interval transferred between sender and recipient.
Datagram	A self-contained data packet that is forwarded in the network with minimum protocol overhead and without an acknowledgement mechanism.
Datex-J	Abbreviation for Data Exchange Jedermann, the T-Online access platform. Local dial-in node in every local network. Some German cities offer additional high-speed access over T-Net/T-Net-ISDN.
Day/Night option	If you want to transfer important calls made after office hours to your home office to an answering machine, so that you are not disturbed, you can use call assignment. You can allocate each subscriber two different call allocations (call assignment Day and call assignment Night). With call assignments, it is also possible to forward the call to an external subscriber, so that you can be contacted at all times.

With call assignment Day/Night, therefore, you define which internal terminals are to ring in the event of an external call. Call assignment Day/Night is achieved using a table in which all the incoming calls are assigned to internal subscribers.

Day/Night/Calendar	You define switching of call variant Day/Night.
DCE	Data Circuit-Terminating Equipment
DCN	Data communications network
Default gateway	Describes the address of the gateway to which all traffic not destined for its own network is sent.
Denial-Of-Service Attack	A Denial-of-Service (DoS) attack is an attempt to flood a gateway or host in a LAN with fake requests so that it is completely overloaded. This means the system or a certain service can no longer be run.
DES	Data Encryption Standard
Destination number memory	Speeddial memory
DHCP	Dynamic Host Configuration Protocol
Dial preparation	On some telephones with a display, you can first enter a telephone, check it first, and then dial it.
Dial-in parameters	Define the dial-in parameters i.e. you enter the provider's dial-in number and specify:
Dialling control	In the configuration for certain terminals, you can define restrictions for external dialling.
Dialup connection	A connection is set up when required by dialling an extension number, in contrast to a leased line.
DIME	Desktop Internetworking Management Environment
DIME Browser	Old name for Configuration Manager.
Direct dial-in	Performance feature of larger PBXs at the point-to-point connection: The extensions can be called directly from outside.
Direct dialling range	See Extension numbers range
Display and output of connection data	In the configuration, it is possible to define storage of data records for specific terminals or all terminals. In the ex works setting, all in-

	coming external connections and all external calls you make are stored.
Display of caller's number	A suitable telephone is a prerequisite for this feature. Transmission of the telephone number must be permitted by the caller.
DLCI	In a Frame Relay network, a DLCI uniquely describes a virtual connection. Note that a DLCI is only relevant for the local end of the point-to-point connection.
DMZ	Demilitarised Zone
DNS	Domain Name System
Do not disturb	Station guarding
DOI	Domain of Interpretation
Domain	A domain refers to a logical group of devices in a network. On the Internet, this is part of a naming hierarchy (e.g. bintec.de).
Door intercom	Door intercom device. It can be connected to various PBXs. A telephone can be used to take an intercom call and open the door.
Door intercom on analogue connection	An analogue connection can be set up for connected of function module M06 to connect a DoorLine intercom system.
Door terminal adapter	The function module can be installed on an analogue connection of your PBX. If a door intercom (DoorLine) is connected to your PBX via a function module, you can speak with a visitor at the door via every authorised telephone. You can assign particular telephones to each ring button. These phones then ring if the ring button is pressed. On analogue telephones, the signal on the telephone matches the intercom call. In place of the internal telephones, an external telephone can also be configured as the call destination for the ring button. Your door intercom can have up to 4 ring buttons. The door opener can be pressed during an intercom call. It is not possible activate the door opener if an intercom call is not taking place.
Dotted Decimal Notation	The syntactic representation of a 32-bit whole number, written in four 8-bit numbers in decimal form and subdivided by a point. It is used to represent IP addresses on the Internet, e.g. 192.67.67.20
Downstream	Data transmission rate from the ISP to the customer.
DSA (DSS)	Digital Signature Algorithm (Digital Signature Standard).

DSL/xDSL	Digital Subscriber Line
DSS1	Digital Subscriber Signalling System
DSSS	Direct Sequence Spread Spectrum is a wireless technology that was originally developed for the military and offers a high level of protection against faults because the wanted signal is spread over a wide area. The signal is spread by means of a spread sequence or chipping code consisting of 11 chips across 22 MHz. Even if there is a fault on one or more of the chips during transfer, the information can still be obtained reliably from the remaining chips.
DTE	Data Terminal Equipment
DTMF	Dual Tone Multi Frequency (tone dialling system)
Dynamic IP address	In contrast to a static IP address, a dynamic IP address is assigned temporarily by DHCP. Network components such as the web server or printer usually have static IP address, while clients such as notebooks or workstations usually have dynamic IP addresses.
E1/T1	E1: European variant of the 2.048 mbps ISDN Primary Rate Interface, which is also called the E1 system.
ECB	Electronic Code Book mode
ECT	Explicit Call Transfer. This performance feature allows two external connections to be transferred without blocking the two B channels of the exchange connection.
Email	Electronic mail
Emergency numbers	You urgently need to contact the police, fire brigade or another telephone number. To make things worse, all the connections are busy. However, you have informed your PBX of the telephone numbers that need to be contactable in an emergency. If you now dial one of these numbers, it is recognised by the PBX and a B channel of the T-ISDN is automatically freed up for your emergency call. Emergency calls are not subject to configuration restrictions. If "Calling with prefix plus code number" is set for a connection, the internal connection is busy. To make an external call, first dial 0 and then the required emergency number.
Encapsulation	Encapsulation of data packets in a certain protocol for transmitting the packets over a network that the original protocol does not directly support (e.g. NetBIOS over TCP/IP).

Encryption	Refers to the encryption of data, e.g. MPPE.
Entry of external connection data	In the ex works setting, all external connections made and received via your PBX are recorded and stored in the form of connection data records.
ESP	Encapsulating Security Payload
ESS	The Extended Service Set describes several BSS (several access points) that form a single, logical wireless network.
Ethernet	A local network that connects all devices in the network (PC, printers, etc.) via a twisted pair or coaxial cable.
Ethernet connections	The 4 connections are led equally through an internal switch. Network clients can be directly connected to the connection sockets. The ports are designed as 100/BaseT full-duplex, autosensing, auto MDIX upwardly compatible to 10/Base T. Up to 4 SIP telephones or IP softclients with SIP standard can be directly connected to PCs with a network card.
Eumex Recovery	If the power supply to the PBX cuts out while new firmware is being loaded, the PBX functions are deleted.
Euro ISDN	Harmonised ISDN standardised within Europe, based on signalling protocol DSS1, the introduction of which network operators in over 20 European countries have committed to. Euro-ISDN has been introduced in Germany, replacing the previous national system 1 TR6.
Eurofile transfer	Communication protocol for the exchange of files between two PCs over ISDN using an ISDN card (file transfer) or telephones or PBXs configured for this.
Exchange	Node in the public telecommunication network. We differentiate between local exchanges and remote exchanges.
Exchange access right	PBXs differentiate between the following "exchange access rights". These can be set up differently for each subscriber in the configuration.
Extended redialling	A selected telephone number is "parked" in the telephone's memory. It can be redialled later, even if you have called other numbers in the meantime.
Extension	For PBXs, describes the terminal (e.g. telephone) connected to the exchange. Each extension can access PBX services and communicate with other extensions.

Extension number	An extension is an internal number for a terminal or subsystem. In point-to-point ISDN accesses, the extension is usually a number from the extension numbers range assigned by the telephone provider. In point-to-multipoint connections, it can be the MSN or a part of the MSN.
Extension numbers range	(direct dialling range)
Fall Back: Priority of the Internet provider entries	The priority of the Internet provider entries is defined by the sequence in which they are entered in the list. The first entry of a DSL connection is the standard access. If a connection cannot be set up via the standard access after a predefined number of attempts, setup is attempted using the second entry then subsequent entries. If the final entry in the list does not enable a connection to be set up successfully, the operation is terminated until a new request is made. When fall back occurs and all other ISPs can only be reached by dialup connections, both B channels may be occupied. If channel bundling is used, you cannot be reached for the duration of this connection.
Fax	Abbreviation of telefax.
FHSS, Frequency Hopping Spread Spectrum	In a FHSS system, the frequency spread is achieved through constantly changing frequencies based on certain hopping patterns. In contrast to DSSS systems, hopping patterns are configured, not the frequency. The frequency changes very frequently in one second.
File transfer	Data transmission from one computer to another, e.g. based on the Eurofile transfer standard.
Filter	A filter comprises a number of criteria (e.g. protocol, port number, source and destination address). These criteria can be used to select a packet from the traffic flow. Such a packet can then be handled in a specific way. For this purpose, a certain action is associated with the filter, which creates a filter rule.
Firewall	Describes the whole range of mechanisms to protect the local network against external access. Your gateway provides protection mechanisms such as NAT, CLID, PAP/CHAP, access lists, etc.
Firmware	Software code containing all a device's functions. This code is written to a PROM (programmable read only memory) and is retained there, even after the device is switched off. Firmware can be updated by the user when a new software version is available (firmware upgrade).

First-level domain	Describes the last part of a name on the Internet. For www.t-com.de, the first-level domain is de and in this case stands for Germany.
Flash key	The flash key on a telephone is the R button. R stands for Rückfrage (inquiry). The key interrupts the line briefly to start certain functions such as inquiries via the PBX.
Follow-me	Performance feature of a PBX for diverting calls on the destination telephone.
Fragmentation	Process by which an IP datagram is divided into small parts in order to meet the requirements of a physical network. The reverse process is known as reassembly.
Frame	Unit of information sent via a data connection.
Frame relay	A packet switching method that contains smaller packets and fewer error checks than traditional packet switching methods such as X.25. Because of its properties, frame relay is used for fast WAN connections with a high density of traffic.
Freecall	Telephone number. Previous service 0130. These telephone numbers have been switched to freecall 0800 since January 1, 1998.
FTP	File Transfer Protocol
Full duplex	Operating mode in which both communication partners can communicate bidirectionally at the same time.
Function keys	Keys on the telephone that can be assigned telephone numbers or network functions.
G.991.1	Data transmission recommendation for HDSL
G.991.2	Data transmission recommendation for SHDSL
G.992.1	Data transmission recommendation for ADSL. See also G.992.1 Annex A and G.992.1 Annex B.
G.992.1 Annex A	Data transmission recommendation for ADSL: ITU-T G.992.1 Annex A
G.992.1 Annex B	Data transmission recommendation for ADSL: ITU-T G.992.1 Annex B
G.SHDSL	See G.991.2.

Gateway	Entrance and exit, transition point
Half duplex	Bidirectional communication method in which it is only possible to either send or receive at a particular point in time. Also known as Simplex.
Handheld unit	Mobile component of wireless telephone units. In the event of digital transmission, it is also possible to make telephone calls between the handheld units (DECT).
Hands free	If the telephone has a microphone and speaker installed, you can conduct a call without using your hands. As a result, other people in the room can also participate in the call.
Hashing	The process of deriving a number (hash) from a character string. A hash is generally far shorter than the text flow it was derived from. The hashing algorithm is designed so that there is a relatively low probability of generating a hash that is the same as another hash generated from a text sequence with a different meaning. Encryption methods use hashing to make sure that intruders cannot change transmitted messages.
HDLC	High Level Data Link Control
HDSL	High Bit Rate DSL
HDSL2	High Bit Rate DSL, version 2
Headset	Combination of headphones and microphone as a useful aid for anyone who makes a lot of telephone calls and wants to keep hands free for making notes.
HMAC	Hashed Message Authentication Code
HMAC-MD5	Hashed Message Authentication Code - uses Message Digest Algorithm Version 5.
HMAC-SHA1	Hashed Message Authentication Code - uses Secure Hash Algorithm Version 1.
Holding a call	A telephone call is put on hold without breaking the connection (inquiry/brokering).
Holding in the PBX	Both B channels of the ISDN connection are needed for the performance features "Call another person during a call" and "Speak alternately with two people" (brokering). As a result, you cannot be reached from outside or make external calls via your PBX's second

	B channel. With this setting, an external caller put on hold hears the PBX's on-hold music.
Hook flash	The use of the inquiry, brokerage and three-party conference special features in T-Net and certain performance features of some PBXs is only possible with the hook flash function (long flash) of the signal key on the telephone. On modern telephones, this key is indicated with an "R".
Host name	A name used in IP networks instead of the corresponding address. A host name consists of an ASCII string that uniquely identifies the host computer.
HTTP	HyperText Transfer Protocol
Hub	Network component used to connect several network components together to form a local network (star-shaped).
IAE	ISDN connection unit, ISDN connection socket.
ICMP	Internet Control Message Protocol
ICV	Integrity Check Value
Identify malicious callers (intercept)	You have to request this performance feature from T-Com. The company will provide you with further information on the procedure. If you enter code 77 during a call or after the caller has ended a call (you hear the engaged tone from the exchange), the caller's telephone number is stored in the exchange. ISDN telephones can also use separate functions for this performance feature. For more information on this function, please see your user's guide.
IEEE	The Institute of Electrical and Electronics Engineers (IEEE). A large, global association of engineers, which continuously works on standards in order to ensure different devices can work together.
IETF	Internet Engineering Task Force
Index	The index from 0...9 is fixed. Every external multiple subscriber number entered is assigned to an index. You need this index when configuring performance features using the telephone's codes, e.g. configuring "Call forwarding in the exchange" or "Define telephone number for the next external call".
Infrastructure mode	A network in infrastructure mode is a network that contains at least one access point as the central point of communication and control. In a network in infrastructure mode, all clients communicate with

each other via access points only. There is no direct communication between the individual clients. A network of this kind is also known as a BSS (basic service set), and a network that consists of several BSS is known as an ESS (extended service set). Most wireless networks operate in infrastructure mode to establish a connection with the wired network.

Inquiry	Makes it possible to put the first call on hold in the event of a call waiting and take a new call.
Internal call tone	Special signal on a PBX to differentiate between internal and external calls.
Internal calls	Free-of-charge connection between terminals in a PBX.
Internal telephone numbers	Your PBX has a fixed internal telephone number plan.
Internet	The Internet consists of a number of regional, local and university networks. The IP protocol is used for data transmission on the Internet.
Internet time sharing	Allows several users to surf the Internet simultaneously over an ISDN connection. The information is requested by the individual computers with a time delay.
Intranet	Local computer network within a company based on Internet technology providing the same Internet services, e.g. homepages and sending email.
IP	Internet Protocol
IP Address	The first part of the address by which a device is identified in an IP network, e.g. 192.168.1.254. See also netmask.
IPComP	IP payload compression
IPCONFIG	A tool used on Windows computers to check or change its own IP settings.
IPoA	IP over ATM
ISDN	Integrated Services Digital Network
ISDN address	The address of an ISDN device that consists of an ISDN number followed by further numbers that relate to a specific terminal, e.g. 47117.

ISDN Basic Rate Interface	ISDN subscriber connection. The Basic Rate Interface consists of two B channels and one D channel. In addition to the Basic Rate Interface, there is the Primary Rate Interface. The interface to the subscriber is provided by an So bus.
ISDN card	Adapter for connecting a PC to the ISDN Basic Rate Interface. From a technical perspective, we differentiate between active and passive cards. Active ISDN cards have their own processor, which handles communication operations independently of the PC processor and therefore does not require any resources. A passive ISDN card, on the other hand, uses the PC's resources.
ISDN Login	Function of your gateway. Your gateway can be configured and administrated remotely using ISDN Login. ISDN Login operates on gateways in the ex works state as soon they are connected to an ISDN connection and therefore reachable via an extension number.
ISDN number	The network address of the ISDN interface, e.g. 4711.
ISDN router	A router that does not have network connections but provides the same functions between PC, ISDN and the Internet.
ISDN-BRI	ISDN Basic Rate Interface
ISDN-Dynamic	This performance feature requires the installation of the T-ISDN Speedmanager. If you are surfing the Internet and use two B channels for downloading, you cannot be reached by telephone from outside. As a further call is signalled over the D channel, your PBX can, depending on the setting, specifically shut down a B channel so that you can take the call.
ISDN-Internal/External	Alternative name for the So bus.
ISDN-PRI	ISDN Primary Rate Interface
ISO	International Standardization Organization
ISP	Internet Service Provider
ITU	International Telecommunication Union
Key Escrow	Stored keys can be viewed by the government. The US government, in particular, requires key storages to prevent crimes being covered up through data encryption.
LAN	Local Area Network

LAPB	Link Access Procedure Balanced
Last access	The last access by T-Service is stored and displayed in the configuration.
Layer 1	Layer 1 of the ISO OSI Model, the bit transfer layer.
LCD	Liquid Crystal Display, a screen in which special liquid crystal is used to display information.
LCP	Link Control Protocol
LDAP	Lightweight Directory Access Protocol
Lease Time	The "Lease Time" is the time a computer keeps the IP address assigned to it without having to "talk" to the DHCP server.
Leased Line	Leased line
LLC	Link Layer Control
Local exchange	Switching node of a public local telephone network that supports the connection of end systems.
Loudspeaker	Function on telephones with an integrated loudspeaker: You can press a button so that the people present in the room can also hear the telephone call.
MAC Address	Every device in the network is defined by a fixed hardware address (MAC address). The network card of a device defines this internationally unique address.
Man-in-the-Middle Attack	Encryption using public keys requires the public keys to be exchanged first. During this exchange, the unprotected keys can be intercepted easily, making a "man-in-the-middle" attack possible. The attacker can set a key at an early stage so that a key known to the "man-in-the-middle" is used instead of the intended key from the real communication partner.
MD5	See HMAC-MD5
MFC	Multifrequency code dialling method
MIB	Management Information Base
Microphone mute	Switch for turning off the microphone. The subscriber on the telephone cannot hear the discussions in the room.

Mixed mode	The access point accepts WPA and WPA2.
MLPPP	Multilink PPP
Modem	Modulator/Demodulator
MPDU	MAC Protocol Data Unit - every information packet exchanged on the wireless medium includes management frames and fragmented MSDUs.
MPPC	Microsoft Point-to-Point Compression
MPPE	Microsoft Point-to-Point Encryption
MSDU	MAC Service Data Unit - a data packet that ignores fragmentation in the WLAN.
MSN	Multiple subscriber number
MSSID	See SSID
MTU	Maximum Transmission Unit
Multicast	A specific form of broadcast in which a message is simultaneously transmitted to a defined user group.
Multiple subscriber number	Multiple subscriber number
Multiprotocol gateway	A gateway that can route several protocols, e.g. IP, X.25, etc.
Music on hold (MoH)	Your PBX has two internal music-on-hold melodies. On delivery, internal melody 1 is active. You can choose between melody 1 or 2, or deactivate the music on hold.
Music on hold (MoH)	Performance feature of a PBX. During an inquiry or call forwarding, a melody is played that the waiting subscriber hears. On your PBX, you can choose between two internal melodies.
MWI	Transmission of a voice message from a mailbox e.g. T-NetBox or MailBox to a terminal. The receipt of the message on the terminal is signalled e.g. by a LED.
NAT	Network Address Translation
NDIS WAN	NDIS WAN is a Microsoft enhancement of this standards in relation to wide area networking (WAN). The NDIS WAN CAPI driver per-

	mits the use of the ISDN controller as a WAN card. The NDIS WAN driver enables the use of a DCN network on Windows. NDIS is the abbreviation for Network Device Interface Specification and is a standard for the connection of network cards (hardware) to network protocols (software).
Net surfing	A "journey of discovery" for interesting information in wide-ranging data networks such as T-Online. Known mainly from the Internet.
NetBIOS	Network Basic Input Output System
Netmask	The second part of an address in an IP network, used for identification of a device, e.g. 255.255.255.0. See also IP address.
Network	Your PBX has a DSL router so that one or more PCs can surf the Internet and download information.
Network address	A network address designates the address of a complete local network.
Network termination (NTBA)	In telecommunications, the network termination is the point at which access to a communication network is provided to the terminal.
Netz-Direkt (keypad functions)	You can use the "Netz-Direkt" (keypad) function (automatic external line access) to enter a key sequence from your ISDN or analogue telephone to use current T-ISDN functions. For more information on this, consult your T-Com client advisor and request the necessary codes (e.g. call forwarding in the exchange).
NMS	Network Management Station
Notebook function	During a telephone call, a telephone number can be entered in the telephone's buffer so that it can be dialled at a later point in time.
NT	Network Termination
NTBA	Network Termination for Basic Access
NTP	Network Time Protocol
OAM	Operation and Maintenance
Offline	Without connection. Connectionless operating state e.g. of the PCs.
Online	With connection. For example the state of a connection between a PC and data network or for data exchange between two PCs.
Online banking	Term for electronic banking e.g. using T-Online.

Online Pass	Part of the T-Com certification services for the Internet. Digital pass for the Internet. With the Online Pass, an Internet user can be authenticated as a customer in a company.
Online services	Services available around the clock via communication services such as T-Online and the Internet.
OSI model	OSI = Open Systems Interconnection
OSPF	Open Shortest Path First
Outgoing extension number signal	The "outgoing extension number signal" is intended for internal connections on the point-to-point to which an explicit extension number was not assigned. When an external call is made, the extension number entered under Outgoing Extension Number Signal is also transmitted.
Outgoing telephone number	If you have not suppressed transmission of your telephone number, and the telephone of the person you are calling supports the CLIP function, the person you are calling can see the telephone number of the connection you are calling from on their telephone display. This telephone number transmitted during an external call is called the outgoing telephone number.
Packet switching	Packet switching
PAP	Password Authentication Protocol
Parking	The call is held temporarily in the exchange. The main difference to on hold: The call is interrupted, the receiver can be replaced. Can be used for brokering. Possible in T-Net, T-ISDN and PBXs. The terminal must have MFC and the R key.
PBX	Private Branch Exchange
PBX	The features offered by a PBX are manufacturer-specific and enable operation of exchanges, free internal calls, callback on busy, and conference calls, among other things. PBXs are used e.g. for office communication (voice, text and data transfer).
PBX	Private Branch Exchange (PBX)
PBX	Private Automatic Branch Exchange
PBX number	A point-to-point ISDN access includes a PBX number and an extension numbers range. The PBX number is used to reach the PBX. A certain terminal of the PBX is then dialled via one of the extension

	numbers of the extension numbers range.
PCMCIA	The PCMCIA (Personal Computer Memory Card International Association) is an industry association founded in 1989 that represents credit card-sized I/O cards such as WLAN cards.
PDM	Abbreviation for pulse dialling method. Conventional dialling procedure in the telephone network. Dialed numbers are represented by a defined number of dc impulses. The pulse dialling method is being replaced by the multifrequency code method (MFC) .
PGP	Pretty Good Privacy
PH	Packet handler
Phone book	The PBX has an internal phone book. You can store up to 300 telephone numbers and the associated names. You can access the PBX's phone book with the funkwerk devices (for example CS 410). You add entries to the phone book using the configuration interface.
PIN	Personal identification number
Ping	Packet Internet Groper
PKCS	Public Key Cryptography Standards
Point-to-multipoint	Point-to-multipoint connection
Point-to-multipoint	Basic connection in T-ISDN with three telephone numbers and two lines as standard. The ISDN terminals are connected directly on the network termination (NTBA) or ISDN internet connection of a PBX.
Point-to-multipoint	Point-to-multipoint
Point-to-multipoint connection for the PBX	You enter the multiple subscriber numbers received from T-Com with the order confirmation in the table fields defined for them in the configuration. As a rule, you receive three multiple subscriber numbers, but can apply for up to 10 telephone numbers for each connection. When you enter the telephone numbers, they are assigned to an "index" and also to a team. Note that initially, all telephone numbers are assigned to team 00. The internal telephone numbers 10, 11 and 20 are entered in team 00 ex works. External calls are therefore signalled with the internal telephone numbers 10, 11 and 20 for the connections entered in team 00.
Point-to-point	Point-to-point

Point-to-point ISDN access	Point-to-point
Polling	Fax machine function that "fetches" documents provided by other fax machines or fax databases.
Port	Input/output
POTS	Plain Old Telephone System
PPP	Point-to-Point Protocol
PPP authentication	Security mechanism. A method of authentication using passwords in PPP.
PPPoA	Point to Point Protocol over ATM
PPPoE	Point to Point Protocol over Ethernet
PRI	Primary Rate Interface
Primary Rate Interface (PRI)	ISDN subscriber connection. The PRI consists of one D channel and 30 B channels (in Europe). (In America: 23 B channels and one D channel.) There is also the ISDN Basic Rate Interface.
Protocol	Protocols are used to define the manner and means of information exchange between two systems. Protocols control and rule the course of data communication at various levels (decoding, addressing, network routing, control procedures, etc.).
Proxy ARP	ARP = Address Resolution Protocol
PSN	Packet Switched Network
PSTN	Public Switched Telephone Network
PVID	Port VLAN ID
R key	Telephones that have a R key (inquiry key) can also be connected to a PBX. In modern telephones, the R key triggers the hook flash function. This is required for use of performance features in T-Net such as inquiry/brokering and three-party conference.
RADIUS	Remote Authentication Dial In User Service
RADSL	Rate-Adaptive Digital Subscriber Line
RAS	Remote access service

Real Time Clock (RTC)	Hardware clock with buffer battery
Receiver volume	Function for controlling the volume in the telephone receiver.
Reconnection on the bus (parking)	For a point-to-multipoint connection, enables the terminal connection to be reconnected to another ISDN socket during the telephone call.
Recording telephone calls	Performance feature of an answering machine. Enables a conversation to be recorded during the telephone call.
Remote	Remote, as opposed to local.
Remote access	Opposite to local access, see Remote.
Remote CAPI	bintec's own interface for CAPI.
Remote diagnosis/remote maintenance	Some terminals and PBXs are supported and maintained by T-Service support offices over the telephone line, which often means a service engineer does not have to visit the site.
Remote query	Answering machine function. Involves listening to messages remotely, usually in connection with other options such as deleting messages or changing recorded messages.
Repeater	A device that transmits electrical signals from one cable connection to another without making routing decisions or carrying out packet filtering. See Bridge and Router.
Reset	Resetting the PBX enables you to return your system to a predefined initial state. This may be necessary if you have made incorrect configuration settings or the PBX is to be reprogrammed.
RFC	Specifications, proposals, ideas and guidelines relating to the Internet are published in the form of RFCs (request for comments).
Rijndael (AES)	Rijndael (AES) was selected as AES due to its fast key generation, low memory requirements and high level of security against attacks. For more information on AES, see http://csrc.nist.gov/encryption/aes .
RIP	Routing Information Protocol
RipeMD 160	RipeMD 160 is a cryptographic hash function with 160 bits. It is regarded as a secure replacement for MD5 and RipeMD.

RJ45	Plug or socket for maximum eight wires. Connection for digital terminals.
Roaming	In a multicell WLAN, clients can move freely and log off from one access point and log on to another when moving through cells, without the user noticing this. This is known as roaming.
Room monitoring (acoustic)	To use the "Room Monitoring" performance feature, the telephone must be activated in the room to be monitored by means of a code, and the receiver must be lifted or "Hands-free" switched on. If you replace the telephone receiver or turn off "Hands-free", room monitored ends and the performance feature is switched off.
Room monitoring from external telephones	This function can be used to monitor rooms from an external telephone.
Room monitoring from internal telephones	You can acoustically monitor a room from an internal telephone in your PBX. This is set up using the telephone procedures described in the user's guide. Please read the information on the described functions in the user's guide.
Router	A device that connects different networks at layer 3 of the OSI model and routes information from one network to the other.
RSA	The RSA algorithm (named after its inventors Rivest, Shamir, Adleman) is based on the problem of factoring large integers. It therefore takes a large amount of data processing capacity and time to derive a RSA key.
RTSP	Real-Time Streaming Protocol
S2M interface	See Primary Rate Interface.
SAD	The SAD (=Security Association Database) contains information on security agreements such as AH or ESP algorithms and keys, sequence numbers, protocol modes and SA life. For outgoing IPSec connections, an SPD entry refers to an entry in the SAD i.e. the SPD defines which SA is to be applied. For incoming IPSec connections, the SAD is queried to determine how the packet is to be processed.
SDSL	Symmetric Digital Subscriber Line
Server	A server offers services used by clients. Often refers to a certain computer in the LAN, e.g. DHCP server.

ServerPass	Part of the T-Com certification services for the Internet. Digital pass for a company. With the ServerPass, T-Com confirms that a server on the Internet belongs to a particular company and that this was verified through the presentation of an excerpt from the business register.
Service 0190	Additional voice service from T-Com for the commercial distribution of private information services. The T-Com services are limited to providing the technical infrastructure and collection processing for the information providers. The provided information is accessed using the telephone number 0190 which is uniform across Germany plus a 6-digit telephone number. Information offering: Entertainment, weather, finance, sport, health, support and service hotlines.
Service 0700	Additional voice service from T-Com. Allows calls to be received via a location-independent telephone number uniform across Germany, starting with the numbers 0700. Free-of-charge routing to national fixed network. Enhancement with Vanity possible.
Service 0900	Additional voice service from T-Com. Replaces Service 0190.
Service number 0180	Additional voice service 0180call from T-Com to receive calls from a location-dependent telephone number uniform across Germany, starting with the numbers 0180.
Setup Tool	Menu-driven tool for the configuration of your gateway. The Setup Tool can be used as soon as the gateway has been accessed (serial, ISDN Login, LAN).
SHA1	See HMAC-SHA.
SHDSL	Single-Pair High-Speed
Short hold	Is the defined amount of time after which a connection is cleared if no more data is transmitted. Short hold can be set to static (fixed amount of time) or dynamic (according to charging information).
Signalling	Simultaneous signalling: All assigned terminals are called simultaneously. If a telephone is busy, call waiting can be used.
Simplex operation (ISDN subscribers only)	This connection can only be used for an ISDN telephone (only T-Concept PX722 system telephones) with a simplex function. If you call an ISDN telephone with a simplex function, this automatically activates the Loudspeaker function so that a conversation can take place immediately. Please see the information on the telephone user's guide on the simplex operation function.

SIP	Session Initiation Protocol
SMS	Short Message Service
SMS receipt	<p>If you have connected an SMS-enabled terminal, you can decide whether SMS receipt is to be permitted for the connection. The ex works setting is no SMS receipt. To receive an SMS with your SMS-enabled terminal, you must register once with the T-Com SMS Service. One-time registration is free. You simply send an SMS containing ANMELD to the destination call number 8888. You then receive a free-of-charge confirmation of registration from the T-Com SMS Service. You can deregister your device or telephone number by sending an SMS containing ABMELD to the destination number 8888. Incoming SMS are then read out. Information on which telephones are SMS-enabled can be obtained from T-Punkt, our customer hotline 0800 330 1000 or on the Internet at http://www.t-com.de.</p>
SMS server telephone numbers	<p>You can connect SMS-enabled telephones to your PBX and thus use the SMS performance feature in the T-Com fixed network. SMSs are forwarded to the recipient via the T-Com SMS server. To send an SMS with an SMS-enabled terminal, the telephone number 0193010 of the SMS server must be prefixed to the recipient number. This telephone number is already stored in your PBX, so manual input of the server telephone is not necessary and does not need to be sent from the telephone. To receive an SMS with your SMS-enabled fixed-network telephone, you must register once with the Deutsche Telekom SMS Service. Charges are made for sending SMSs. There are no costs for receiving SMSs.</p>
SNMP	Simple Network Management Protocol
SNMP shell	Input level for SNMP commands.
So bus	<p>All ISDN sockets and the NTBA of an ISDN point-to-multipoint connection. All So buses consist of a four-wire cable. The lines transmit digital ISDN signals. The So bus is terminated with a terminating resistor after the last ISDN socket. The So bus starts at the NTBA and can be up to 150 m long. Any ISDN devices can be operated on this bus. However, only two devices can use the So bus at any one time, as only two B channels are available.</p>
So connection	See ISDN Basic Rate Interface
So interface	<p>Internationally standardised interface for ISDN systems. This interface is provided on the network side by the NTBA . On the user</p>

side, the interface is intended for connecting a PBX (point-to-point connection) and for connecting up to eight ISDN terminals (point-to-multipoint connection).

SOHO

Small Offices and Home Offices

SPD

The SPD (=Security Policy Database) defines the security services available for IP traffic. These security services are dependent on parameters such as the source and destination of the packet etc.

Special features

Performance features of the T-Net and T-ISDN networks such as display of the caller's number, callback on busy, call forwarding, changeable connection lock, changeable telephone number lock, connection without dialling and transmission of charge information. Availability depends on the standard of the connected terminals.

Special-features connection

T-ISDN Basic Rate Interface with an extensive range of services: call waiting, call forwarding, third-party conference, display of call costs at the end of a connection, inquiry/brokering, telephone number transmission. In the special-features connection, three multiple subscriber numbers are included as standard.

Specify own telephone number for next call

If you want to make a business call late in the evening from your private sphere - say the living room - for example, you can define your business telephone number as the outgoing multiple subscriber number (MSN) for this call. The advantages of this are that the costs for the connection are recorded for the selected MSN and the person you are calling can identify you by the transferred MSN. Before you call an external number, you can define which of your telephone numbers is to be sent to the exchange and called party. You make the selection using the telephone number index.

Speeddial number

A speeddial index (000...299) can be assigned to each of the 300 telephone numbers in the telephone book. You then dial this speeddial index instead of the long telephone number. Note that telephone numbers dialled using the speeddial function must also comply with the dialrule.

SPID

Service Profile Identifier

Splitter

The splitter separates data and voice signals on the DSL connection.

Spoofing

Technique for reducing data traffic (and thus saving costs), especially in WANs.

SSID	The Service Set Identifier (SSID) or Network Name refers to the wireless network code based on IEEE 802.11.
SSL	Secure Sockets Layer A technology, now standard, developed by Netscape, which is generally used to secure HTTP traffic between a web browser and a web server.
STAC	Data compression procedure.
Standard connection	T-ISDN Basic Rate Interface with the performance features Inquiry/ Brokering and Telephone Number Transmission. The standard connection contains three multiple subscriber numbers.
Static IP address	A fixed IP address, in contrast to a dynamic IP address.
Station guarding	Deactivation of acoustic call signalling: do not disturb.
Subaddressing	In addition to the transmission of ISDN telephone numbers, additional information in the form of a subaddress can be transmitted from the caller to the called party over the D channel when the connection is set up. Addressing that goes beyond the pure MSN, which can be used e.g. specifically to locate several ISDN terminals that can be reached on one telephone number for a particular service. In the called terminal - e.g. a PC - various applications can also be addressed and in some cases executed. Costs are charged for the performance feature, and it must be requested separately from the network operator.
Subnet	A network scheme that divides individual logical networks into smaller physical units to simplify routing.
Subnet mask	A method of splitting several IP networks into a series of subgroups or subnetworks. The mask is a binary pattern that must match the IP addresses in the network. 255.255.255.0 is the default subnet mask. In this case, 254 different IP addresses can occur in a subnet, from x.x.x.1 to x.x.x.254.
Subscriber Name	To distinguish between connections more easily, you can assign a subscriber name for each internal subscriber.
Suppress A-telephone number (CLIR)	CLIP/CLIR: Calling line identification presentation/calling line identification restriction
Suppress B telephone number (COLR)	COLP/COLR: Connected line identification presentation/connected line identification restriction = Activate/suppress transmission of called party's telephone number to caller. This performance feature

	suppresses the display of the called subscriber's telephone number. If display of the B telephone number is suppressed, your telephone number is not transmitted to the caller when you take a call.
Suppress own telephone number	Temporary deactivation of the transmission of your own telephone number.
Suppression of the telephone number	Performance feature of a PBX. The display of the telephone number can be deactivated on an individual basis.
Switch	LAN switches are network components with a similar function to bridges or even gateways. They switch data packets between the input and output port. In contrast to bridges, switches have several input and output ports. This increases the bandwidth in the network. Switches can also be used for conversion between networks with different speeds (e.g. 100-mbps and 10-mbps networks).
Switchable dialling method	Option of switching between the pulse dialling method and MFC method by means of a switch or key input on the terminal, such as the telephone or fax machine.
Synchronous	Transmission process in which the sender and receiver operate with exactly the same clock signals – in contrast to asynchronous transmission. Spaces are bridged by a stop code.
Syslog	Syslog is used as the de facto standard for transmitting log messages in an IP network. Syslog messages are sent as unencrypted text messages over the UDP port 514 and collected centrally. They are usually used to monitor computer systems.
System telephones	Telephone that belongs to a modern PBX, which - depending on the PBX - has a number of special features and keys, e.g. the T-Concept PX722.
T-DSL	Product name used by Deutsche Telekom AG for its DSL services and products.
T-Fax	Product name for T-Com fax machines.
T-ISDN	Telephony, faxing, data transfer and online services from one network and a single connection: T-ISDN offers exciting services with numerous benefits, for example a point-to-multipoint connection - the ideal solution for families or small businesses. This connection option, which can be used with the existing telephone cable, costs less than two telephone connections but offers far greater quality and ease of use: Two independent lines, so that you can still make a

phone call, receive a fax, or surf the Internet when another family member is making a long call on the other line. Three or more telephone numbers, which you can assign individually to your devices and distribute differently if needed through simple programming steps. Most ISDN telephones can "manage" several telephone numbers, so you can set up a "central" telephone in your household, for example, to allow you to react to calls to all ISDN telephone numbers with this telephone. The fax and telephone in your home office can also each be assigned a number, as can your son or daughter's phone. As a result, each family member can be contacted with a separate number, helping to eliminate "day-to-day friction"! And as far as the costs are concerned, on request you can have your bill broken down to show which units have been charged for the individual ISDN telephone numbers.

T-Net	The digital telephone network of T-Com for connecting analogue terminals.
T-NetBox	The answering machine in T-Net and T-ISDN. The T-NetBox can store up to 30 messages.
T-NetBox telephone number	Enter the current T-NetBox telephone number here if it differs from the 08003302424 entered ex works. As soon as your T-NetBox receives a voice or fax message, notification is sent to your PBX.
T-Online	Umbrella term the T-Com online platform. Offers services such as e-mail and Internet access.
T-Online software	T-Com software decoder for all conventional computer systems that enables access to T-Online. Supports all functions such as KIT, e-mail and the Internet with a browser. T-Online users receive this software free of charge.
T-Service	T-Service carries out all installation work and configurations for the PBX at the customer's request. The service ensures optimum voice and data transmission at all times thanks to maintenance work.
T-Service access	T-Service access enables you to have your PBX configured by T-Service. Give T-Service a call! Get advice and provide information on your configuration requirements. T-Service will then configure your PBX remotely without you having to do anything.
TA	Terminal Adapter
TAPI	Telephony Application Program Interface

TAPI configuration	You can use the TAPI configuration to modify the TAPI driver in line with the program that uses this driver. You can check which MSN is to be assigned to a terminal, define a line name, and configure the dialling parameters. First configure your PBX. You must then configure the TAPI interface. Use the "TAPI Configuration" program.
TCP	Transmission Control Protocol
TCP/IP	Transmission Control Protocol/Internet Protocol
TCU	Telecommunication connection unit
TE	Terminal equipment
TEI	Terminal Endpoint Identifier
Telefax	Term that describes the remote copying for transmitting texts, graphics and documents true to the original over the telephone network.
Telematics	Telematics is a combination of telecommunication and computer technology and describes data communication between systems and devices.
Telnet	Protocol from the TCP/IP protocol family. Telnet enables communication with a remote device in the network.
Terminal adapter	Device for interface adaptation. It enables different equipment to be connected to T-ISDN. The terminal adapter a/b is used to connect analogue terminals to the So interface of the ISDN Basic Rate Interface. Existing analogue terminals can still be operated with tone dialling.
TFTP	Trivial File Transfer Protocol
Tiger 192	Tiger 192 is a relatively new and very fast hash algorithm.
TLS	Transport Layer Security
Tone dialling	Multifrequency code method (MFC)
Transfer internal code	If you receive an internal call, e.g. from the subscriber with internal telephone number 22, while you are away, this subscriber's internal telephone number is stored in your telephone's caller list. However, because your connection is automatically set to Automatic Outside Line as a result of the ex works settings, you would first have to dial ** for a callback in order to obtain the internal dialling tone, and then

22. If "Transfer Internal Code" is active, ** is placed before the 22 and the callback can be made directly from the caller list.

Transmission speed	The number of bits per second transmitted in T-Net or T-ISDN from the PC or fax machine. Fax machines achieve up to 14.4 kbps, modems 56 kbps. In the ISDN, data and fax exchange with 64 kbps is possible. With T-DSL, up to 8 mbps can be received and up to 768 kbps sent.
TSD	Terminal Selection Digit
TTL	TTL stands for Time to Live and describes the time during which a data packet is sent between the individual servers before it is discarded.
Twofish	Twofish was a possible candidate for the AES (Advanced Encryption Standard). It is regarded as just as secure as Rijndael (AES), but is slower.
U-ADSL	Universal Asymmetric Digital Subscriber Line
UDP	User Datagram Protocol
Update	Update to a software program (PBX firmware). An update is the updated version of an existing software product, and is indicated by a new version number.
Upload	Data transfer during online connections, where files are transferred from the user's PC to another PC or to a data network server.
UPnP	Universal Plug and Play
Upstream	Data transmission rate from the client to the ISP.
URL	Universal/Uniform Resource Locator
USB	Universal Serial Bus
User guidance	Electronic user guidance that takes the user through the required functions of a terminal such as a telephone, answering machine or fax machine step by step (menu-guided operation).
UUS1 (User to User Signalling 1)	This function is only possible for system telephones and ISDN telephones.
V.11	ITU-T recommendation for balanced dual-current interface lines (up to 10 mbps).

V.24	CCITT and ITU-T recommendation that defines the interface between a PC or terminal as Data Terminal Equipment (DTE) and a modem as Data Circuit-terminating Equipment (DCE).
V.28	ITU-T recommendation for unbalanced dual-current interface line.
V.35	ITU-T recommendation for data transmission at 48kbps in the range from 60 to 108kHz.
V.36	Modem for V.35.
V.42bis	Data compression procedure.
V.90	ITU standard for 56 kbps analogue modems. In contrast to older V.34 modems, data is sent in digital form to the client when the V.90 standard is used and does not need to be first converted from digital to analogue on one side of the modem (provider), as was the case with V.34 and earlier modems. This makes higher transmission rates possible. A maximum speed of 56 kbps can be achieved only under optimum conditions.
Vanity	Letter dialling
VDSL	Very high bit rate digital subscriber line (also called VADSL or BD-SL).
VID	VLAN ID
VJHC	Van Jacobson Header Compression
VLAN	Virtual LAN
VoIP	Voice over IP
VPN	Virtual Private Network
VSS	Virtual Service Set
WAN	Wide Area Network
WAN interface	WAN interface
WAN partner	Remote station that is reached over a WAN, e.g. ISDN.
Web server	Server that provides documents in HTML format for access over the Internet (WWW).
Webmail	T-Online service with which e-mails can be sent and received world-

wide on the Internet by means of a browser.

WEP	Wired Equivalent Privacy
Western plug	(also known as RJ-45 plug) Plug used for ISDN terminals with eight contacts. Developed by the US telephone company Western Bell. Western plugs for analogue telephones have four or six contacts.
WINIPCFG	A graphical tool on Windows 95, 98 and Millennium that uses Win32 API to view and configure the IP address configuration of computers.
WLAN	A group of computers wirelessly connected to each other (wireless LAN).
WMM	Wireless multimedia
WPA	Wi-Fi-protected access
WPA Enterprise	Concentrates primarily on the needs of companies and offers secure encryption and authentication. Uses 802.1x and the Extensible Authentication Protocol (EAP) and thus offers an effective means of user authentication.
WPA-PSK	Intended for private users or small businesses that do not run a central authentication server. PSK stands for Pre-Shared Key and means that AP and client use a fixed character string (8 to 63 characters) known to all subscribers as the basis for key calculation for wireless traffic.
WWW	World Wide Web
X.21	The X.21 recommendation defines the physical interface between two network components in packet-switched data networks (e.g. Datex-P).
X.21bis	The X.21bis recommendation defines the DTE/DCE interface to V-series synchronous modems.
X.25	An internationally agreed standard protocol that defines the interface between network components and a packet-switched data network.
X.31	ITU-T recommendation on the integration of X.25-compatible DTEs in ISDN (D channel).
X.500	ITU-T standards that cover user directory services, see LDAP. Example: The phone book is the directory in which you find people on

the basis of their name (agreement with the telephone directory). The Internet supports several databases with information on users, such as e-mail addresses, telephone numbers and postal addresses. You can search these databases to obtain information about individuals.

X.509

ITU-T standards that define the format of the certificates and certificate queries and their use.

Index

287 , 309

Client Link Description 219
 Configuration Encryption 470
 Modem Init Sequence 157
 Monitored IP Address 449

#

489 , 490 , 496 , 498
 #1, #2, #3 366

A

Access 441
 ACCESS_ACCEPT 147
 ACCESS_REJECT 147
 ACCESS_REQUEST 147
 ACCOUNTING_START 147
 ACCOUNTING_STOP 147
 ACL Mode 212
 Action 219 , 219 , 375 , 437 , 470 ,
 490 , 496
 Action if license not registered 434
 Action if Server not reachable 434
 Active IPSec Tunnels 124
 Active Sessions 124
 Additional Wire Pairs 176
 Address 382
 Address Mode 185 , 292
 Address Range 382
 Address Type 382
 Administrative Status 314 , 389 , 397
 , 402 , 404
 ADSL chipset 173
 ADSL Logic 470
 ADSL Mode 174
 ADSL SyncType 174
 Alert service 480
 Alive Check 149 , 327 , 333 , 491
 All Multicast Groups 246

Allow deleting/editing all routing
 entries 227
 Allowed Addresses 212
 Always Active 282
 Always on 256 , 261 , 266 , 271 , 278
 , 343 , 350
 Answer to client request 464
 Antenna Diversity 194
 AP MAC Address 219 , 504 , 505
 APN (Access Point Name) 157 , 182
 Apply QoS 375
 ARP Processing 209
 Associated Line 408
 Association Advantage 202
 ATM Interface 176 , 290
 ATM PVC 266
 ATM Service Category 295
 Authentication 259 , 263 , 268 , 273 ,
 280 , 284 , 346 , 353
 Authentication for PPP Dialin 155
 Authentication ID 393 , 397
 Authentication Method 323 , 491
 Authentication Password 460
 Authentication Type 148 , 152
 Autoconfig on Bootup 163
 Autosave Mode 367
 AUX Port Status 157

B

Back Route Verify 227 , 317
 Based on Ethernet Interface 185
 Beacon Period 200
 Bearer Service 171
 Blacklisted 439
 Block after connection failure for 259 ,
 263 , 268 , 273 , 280 , 284 , 346 ,
 353
 Block Time 153 , 327
 Blocked 253
 BOSS 470
 BOSS Version 124
 Bundle Type 169

C

- CA Certificate 363
 - CA Certificates 327
 - Cache Hitrate (%) 423
 - Cache Hits 423
 - Cache Size 416
 - Call Number 276 , 287
 - Callback 355
 - Callback Mode 273 , 284
 - Called Address 402 , 406
 - Called Address Translation 404
 - Called Line 406
 - Calling Address 402
 - Calling Address Translation 406
 - Calling Line 402 , 406
 - CAPI Server TCP Port 442
 - Category 437
 - Certificate is CA Certificate 360
 - Certificate Request Description 363
 - Certificate Revocation List (CRL)
 - Checking 360
 - Channel 194 , 219 , 494
 - Channel Bundling 275
 - Channel Selection 166
 - Channel Sweep 202
 - Charge 494 , 495
 - Cleaning 5
 - Client MAC Address 501
 - Client mode 194
 - Client Type 293
 - Clock Mode 166
 - Clock Rate 176
 - Code 384
 - Codec Proposal Sequence 395 , 400
 - Comfort Noise Generation 396 , 401
 - Common Name 365
 - Compression 142 , 304 , 307
 - Configuration Interface 139
 - Configured Speed / Mode 160
 - Confirm Admin Password 129
 - Connected 219
 - Connection Idle Timeout 256 , 261 , 266 , 271 , 278 , 282 , 343 , 350
 - Connection Type 271 , 343
 - Connector Type 179
 - Consider 243
 - Contact 127
 - Continuity Check (CC) End-to-End 300
 - Continuity Check (CC) Segment 300
 - Control Mode 311
 - Controlled interfaces 450
 - Corresponding NAT entry for outgoing connection 230
 - Country 365
 - CPU Usage 124
 - Create NAT Policy 258 , 262 , 267 , 272 , 279 , 283 , 344 , 351
 - CTS frames received in response to an RTS 498
 - Current File Name in Flash 470
 - Current Speed / Mode 160
 - Current System Time 131
 - Custom 365
 - Custom Time Slots 166
 - CW Max 200
 - CW Max. 202
 - CW Min 200
 - CW Min. 202
- D**
- D Channel Mode 320
 - Data Packets Sequence Numbers 341
 - Data rate Mbit/s 499 , 501 , 502 , 503 , 504 , 505
 - Date 489
 - Day 437
 - Default Drop Extension 410
 - Default Ethernet for PPPoE Interfaces 292
 - Default Route 258 , 262 , 267 , 272 , 279 , 283 , 303 , 306 , 309 , 315 , 344 , 351 , 358
 - Default Route Distribution 239
 - Delete complete IPsec configuration 335
 - Description 169 , 256 , 261 , 266 , 271 , 278 , 282 , 290 , 303 , 306 ,

309 , 314 , 323 , 331 , 339 , 343 ,
350 , 358 , 360 , 370 , 381 , 382 ,
383 , 384 , 387 , 389 , 393 , 397 ,
402 , 406 , 408 , 418 , 432 , 444 ,
490 , 491 , 496 , 498
Description of the client link 504
Destination 375
Destination File Name 470
Destination Interface 246
Destination IP Address 454 , 455
Destination IP Address / Netmask
222
Destination Port 224 , 233
Destination Port Range 384
Details 490
Detection Mode 179
Device Mode 176
DH Group 323
DHCP Hostname 186 , 292
DHCP MAC Address 186 , 292
DHCP Options 430
Dial Latency 410
Dialling Number 457
Direction 238 , 408 , 494 , 495
Distance 200
Distribution Mode 243
Distribution Policy 243
Distribution Ratio 244
DNS Negotiation 259 , 263 , 268 ,
276 , 280 , 284 , 347 , 354
DNS Requests 423
DNS Server 420
DNS Server Configuration 415
DNS Test 467
Domain 420
Domain Name 415
Dormant 253
Down 253
Downstream 174
Drop non-members 190
Drop untagged frames 190
Dropped 493
DSA Key Status 144
DSCP / TOS Value 224

DSP Module 125
DTIM Period 200
Duplicate received MSDUs 498
Duration 494 , 495
Dynamic RADIUS Authentication 336

E

E-mail 365
Echo Cancellation 396 , 401
ED Threshold 200 , 202
Enable Discovery Server 462
Enable IPsec 335
Enable Server 442
Enable Update 425
Enable VLAN 191
Enable Web Filter 434
Encapsulation 290
Encrypted 493
Encryption 153 , 273 , 346 , 353
Encryption Algorithms 143
End-to-End Pending Requests 298
End-to-End Send Interval 298
Entries 276 , 287
Entry active 148 , 152
Error 493
Ethernet Interface Selection 160
Expire Time 393 , 397
Extended Route 222
Extension 166 , 399
Extension / User Name 393
External Address 408
External Filename 368 , 369
External IP address 230
External Port 391

F

Facility 475
Fallback Interface to get DNS Servers
416
File Encoding 368 , 369
Filename 470
Filtered input interface(s) 434
FilterRules 378

- Firewall Status 379
- Force Certificate to be trusted 360
- Forward to 420
- Forwarded Requests 423
- Forwarding 420
- Fragmentation Threshold 200 , 202
- Frame transmissions without ACK received 498
- G**
- Garbage Collection Timer 240
- Gateway 222 , 430 , 460
- Generate Private Key 363
- GPRS/UMTS Interface 278
- GRE Window Adaption 356
- GRE Window Size 356
- Group Description 243
- Group ID 449 , 450
- H**
- Hashing Algorithms 143
- Hello Interval 341
- Hold Down Timer 241
- Host 420
- Host Name 425
- HTTP 140
- HTTPS 140
- I**
- IEEE 802.11d Compliance 194
- IGMP Proxy 250
- IGMP State Limit 251
- IGMP Status 251
- Ignore Certificate Request Payloads 337
- IKE (Phase 1) SAs 491
- IKE (Phase1) 493
- Include Certificates and Keys 470
- Incoming ISDN Number 320 , 355
- Incoming Number 457
- Incoming Service Type 157 , 182
- Interface 141 , 179 , 190 , 222 , 227 , 230 , 238 , 244 , 248 , 311 , 378 , 420 , 425 , 429 , 449 , 452 , 453 , 460 , 494 , 495
- Interface Action 449 , 452 , 453
- Interface Description 139
- Interface is UPnP controlled 464
- Interface Leads 179
- Interface Mode 185
- Interface Type 179 , 393
- Internal IP Address 391
- Internal Port 391
- Internal Time Server 132
- Interval 450 , 454 , 455
- Intra-cell Repeating 209
- Invalid DNS Packets 423
- Invalid packets received 498
- IP Accounting 477
- IP accounting message format 478
- IP Address 238 , 292 , 293 , 418 , 432 , 460 , 475 , 485 , 499 , 501
- IP Address Assignment 315
- IP Address Mode 258 , 262 , 267 , 272 , 279 , 283 , 344 , 351
- IP Address Range 429
- IP Address to use for DNS/WINS Server Assignment 416
- IP Address/Netmask 185
- IP Assignment Pool 272 , 283 , 315
- IP Assignment Pool (IPCP) 344 , 351
- IP Compression 333
- IP Pool Name 289 , 334
- IP Pool Range 289 , 334
- IPSec (Phase2) 493
- IPSec Debug Level 335
- IPSec Tunnels 492
- ISDN Configuration Type 163
- ISDN Line Framing 166
- ISDN Port 171
- ISDN Switch Type 163 , 166
- ISDN Theft Protection Service 457
- ISDN Usage External 124
- ISDN Usage Internal 124
- K**
- Key Value 358

L

Last Member Query Interval 248
 Last Write Result 460
 Layer 2 Mode 179
 Layer 4 Protocol 224
 LCP Alive Check 259 , 263 , 268 ,
 280 , 284 , 304 , 307 , 309 , 346 ,
 353
 LDAP URL Path 370
 Lease Time 430
 Level 475 , 489
 Licence Key 136 , 435
 Licence Serial Number 136
 License Status 435
 License valid until 435
 Lifetime 323 , 331
 Line Speed 157
 Line Speed Interval 176
 Local Address 408
 Local Certificate 323
 Local Certificate Description 368 ,
 369
 Local GRE IP Address 358
 Local Hostname 339
 Local ID 491
 Local ID Type 323
 Local ID Value 323
 Local IP Address 222 , 258 , 262 ,
 267 , 272 , 279 , 283 , 303 , 306 ,
 309 , 315 , 341 , 344 , 351 , 358 ,
 491
 Local PPTP IP Address 263
 Locality 365
 Location 127
 Logged Actions 379
 Logging Level 142
 Long Retry Limit 200 , 202
 Loopback End-to-End 298
 Loopback Segment 298
 Low Latency Transmission 389

M

MAC Address 185 , 292 , 432 , 460 ,
 499
 Mail Exchanger (MX) 426
 Management VID 191
 Map to host 233
 Matching String 481
 Max Receive Lifetime 200
 Max Transmit MSDU Lifetime 200
 Max. link range 194
 Max. Receive Lifetime 202
 Max. Time Period for Active Scan 202
 Max. Time Period for Passive Scan
 202
 Max. Transmission Rate 198
 Max. Transmit MSDU Lifetime 202
 Maximum burst size (MBS) 295
 Maximum Groups 251
 Maximum Message Level of Syslog
 Entries 127
 Maximum Messages per Minute 480
 Maximum Number of Accounting Log
 Entries 127
 Maximum Number of Dialup Retries
 259 , 263 , 268 , 273 , 280 , 284
 Maximum number of history entries
 434
 Maximum number of IGMP status mes-
 sages 248
 Maximum Number of Syslog Entries
 127
 Maximum Response Time 248
 Maximum Retries 341
 Maximum Sources 251
 Maximum Time between Retries 341
 Maximum TTL for Negative Cache
 Entries 416
 Maximum TTL for Positive Cache
 Entries 416
 Maximum Upload Speed 311
 Maximum upstream bandwidth 174
 Mbps 497
 Media Stream Termination 410
 Members 381 , 387
 Memory Usage 124

Message 489
 Message Compression 481
 Message Timeout 481
 Messages 491
 Metric 222
 Metric Offset for Active Interfaces 238
 Metric Offset for Inactive Interfaces 238
 Min. Time Period for Active Scan 202
 Min. Time Period for Passive Scan 202
 Minimum Time between Retries 341
 Mode 219, 224, 227, 248, 251, 276, 287, 320, 323, 363
 Mode / Bridge Group 139
 Modem Escape Character 157
 Modem Init Sequence 182
 Monitored Interface 452, 453
 Monitored interfaces 457, 486
 Monitored IP Address 450
 MSDUs that could not be transmitted 498
 MSN 171
 MSN Recognition 171
 MTU 358, 491
 Multicast Group Address 246
 Multicast MSDUs received successfully 498
 Multicast MSDUs transmitted successfully 498

N

NAT Active 228
 NAT Traversal 327
 Negative Cache 416
 Negotiation Type 491
 Netmask 222, 238, 292, 293, 344, 460
 Network Name (SSID) 209, 216, 219
 Network Quality 182
 Network Type 222
 New Date 132
 New File Name 470
 New Time 132

Nitro Mode 198
 Nitro XM 198
 Node Name 460
 Noise dBm 499, 501, 502, 503, 504, 505
 Number Called 457
 Number of Dial Retries 458
 Number of Messages 481

O

OAM Flow Level 298
 Operation Band 194
 Operation Mode 194
 Organisation 365
 Organisational Unit 365
 OSPF Mode 276, 304, 307, 309, 347, 354
 Other Inactivity 380
 Outbound Line 404
 Outbound Proxy 397
 Outgoing ISDN Number 320, 355

P

Packet Size 396, 401
 Passed 493
 Password 256, 261, 266, 271, 278, 282, 339, 343, 350, 363, 368, 369, 393, 397, 425, 441, 470, 480, 486
 Peak Cell Rate (PCR) 295
 Peer Address 314
 Peer ID 314
 Penalty Value 202
 Phase-1 Profile 316
 Phase-2 Profile 316
 Physical connection 173
 Physical Interface - Interface Specifics - Link 125
 Ping 140
 Ping Test 466
 Poisoned Reverse 239
 Policy 149, 153
 Pool Usage 429

- POP3 Server 480
- POP3 Timeout 480
- Port 230 , 427
- Port Name 163 , 166
- Port Usage 163 , 166 , 276 , 287
- Portforwardings 228
- Positive Cache 416
- PPPoE Ethernet Interface 256
- PPPoE Interfaces for Multilink 256
- PPPoE Mode 256
- PPTP Address Mode 263
- PPTP Inactivity 380
- PPTP Interface 261
- PPTP Mode 350
- PPTP Passthrough 228
- Preshared Key 210 , 216 , 314
- Primary 415 , 415
- Primary DHCP Server 433
- Primary Timeserver 132
- Prioritize TCP ACK Packets 259 , 263 , 268 , 280 , 284 , 293 , 304 , 307 , 309 , 346 , 353
- Priority 148 , 152 , 404
- Privacy 214
- Propagate PMTU 333
- Proposals 323 , 331
- Protocol 230 , 384 , 389 , 391 , 393 , 397 , 427 , 475
- Provider 290 , 425
- Provider Name 427
- Proxy ARP 186 , 317
- Proxy ARP Mode 276 , 287 , 304 , 307 , 309 , 347 , 354
- Proxy Interface 250
- PVID 190
- Q**
- Query Interval 248
- R**
- RA Encrypt Certificate 363
- RA Sign Certificate 363
- Radio 194
- RADIUS Dialout 149
- RADIUS Secret 148
- Rate 501 , 503 , 505
- Realm 397
- Receive Version 235
- Received DNS Packets 423
- Received MPDU that couldn't be decrypted 498
- Recent System Logs 125
- Recipient 481
- Region 220
- Registrar 397
- Registration 393 , 397
- Remote GRE IP Address 358
- Remote Hostname 339
- Remote ID 491
- Remote IP Address 340 , 490 , 491
- Remote IP Address / Netmask 230
- Remote MAC 502 , 503
- Remote MAC Address 215
- Remote network 230
- Remote Networks 490
- Remote Number 494 , 495
- Remote Port 391
- Remote PPTP IP Address 263 , 350
- Remote User (for Dialin only) 271
- Requested Rate 176
- Response 418
- Result of Autoconfiguration 163
- Retransmission Timer 241
- Retries 149
- RFC 2091 Variable Timer 239
- RFC 2453 Variable Timer 239
- RIP UDP Port 239
- Roaming Profile 202
- Robustness 248
- Route Announce 235
- Route Entries 258 , 262 , 267 , 272 , 279 , 283 , 303 , 306 , 309 , 315 , 344 , 351 , 358
- Route Timeout 240
- Route Type 222
- RSA Key Status 144
- RSSI Advantage 202

- RTS frames with no CTS received 498
- RTS Threshold 200, 202
- Rx Bytes 496
- Rx Errors 496
- Rx Packets 496, 497, 499, 501, 502, 503, 504
- S**
- Scan Channels 202
- Scan Interval 202
- Scan Threshold 202
- SCEP URL 363
- Schedule (Start/Stop Time) 437
- Schedule Interval 447
- Secondary 415, 415
- Secondary DHCP Server 433
- Secondary Timeserver 132
- Security Algorithm 490
- Security Mode 210, 216
- Segment Pending Requests 298
- Segment Send Interval 298
- Select Action 444
- Select analogue interface 393
- Select File 470
- Select Interface 444
- Select ISDN interface 393
- Select radio 444
- Selected Channels 202
- Selected Ports 355
- Selection 383
- Send Certificate Chains 337
- Send Certificate Request Payloads 337
- Send CRLs 337
- Send Information to 486
- Send Initial Contact Message 336
- Send Key Hash Payloads 337
- Send Version 235
- Sender E-mail Address 480
- Serial Number 124
- Server 427
- Server Failures 423
- Server IP Address 148, 152
- Server Timeout 149
- Service 171, 230, 375, 494, 495
- Session Border Controller Mode 410
- Session Timeout 389
- Severity 481
- SHDSL Logic 470
- SHDSL Type 176
- Short Retry Limit 200, 202
- Show passwords and keys in clear text 130
- Signal 219
- Signal dBm 499, 501, 502, 503, 504, 505
- Silent Deny 228
- SIM Card Uses PIN 157, 182
- SIP Endpoint IP Address 393
- SIP Header Field(s) for Caller Address 399
- SMTP Authentication 480
- SMTP Server 480
- SNMP 140
- SNMP Lists UDP Port 145
- SNMP Read Community 129
- SNMP Trap Broadcasting 484
- SNMP Trap Community 484
- SNMP Trap UDP Port 484
- SNMP Version 145
- SNMP Write Community 129
- SNR 219
- SNR dB 501, 505
- Sort Order 395, 400
- Source 375
- Source File Name 470
- Source Interface 224, 246
- Source IP Address 224, 450, 454, 455
- Source Location 444, 470
- Source Port 224
- Source Port Range 384
- Specific Ports 355
- Specify bandwidth 378
- Speed Dialing 412
- SSH 140
- SSH Service Active 142

Stack 494
 Start mode 316
 Start Time 446 , 495
 State/Province 365
 Status 449 , 452 , 454 , 490 , 492 ,
 494 , 496
 Stop Time 446
 Subnet 382
 Subsystem 482 , 489
 Successfully Answered Queries 423
 Summary 365
 Sustained Cell Rate (SCR) 295
 Switch Port 160
 Sync SAs with ISP interface state 336
 System Admin Password 129
 System Date 124
 System Logic 470
 System Name 127

T

TACACS+ Secret 152
 TCP Inactivity 380
 TCP Keepalives 142
 TCP Port 153
 TCP-MSS Clamping 186
 Telnet 140
 TFTP File Name 444
 TFTP server 444
 Third Timeserver 132
 Time 489
 Time Condition 446
 Time Offset from GMT 132
 Time Update Interval 132
 Time Update Policy 132
 Timeout 153 , 458
 Timeslot Matrix 169
 Timeslot Range 169
 Timeslot Selection 169
 Timestamp 475
 Total 493
 Traceroute Test 468
 Traffic Priority 375
 Traffic Shaping 378
 Transfer Mode 320

Transfer Own IP Address over ISDN
 320
 Transmit Key 210 , 214 , 216
 Transmit Power 194
 Transmit Shaping 174
 Transmitted MPDUs 498
 Trials 450
 Trigger 452 , 453
 Trunk Line 404
 Trunk Mode 397
 TTL 418
 Tunnel Profile 343
 Tx Bytes 496
 Tx Errors 496
 Tx Packets 496 , 497 , 499 , 501 ,
 502 , 503 , 504
 Type 290 , 402 , 496
 Type of Endpoint 391
 Type of Messages 475
 Type/Code 384

U

UDP Destination Port 340 , 348 , 486
 UDP Inactivity 380
 UDP Port 149
 UDP Source Port 340
 UDP Source Port Selection 348
 UMTS/HSDPA/HSUPA Status 182
 Unchanged for 496
 Unicast MPDUs received successfully
 498
 Unicast MSDUs transmitted
 successfully 498
 Up 253
 Update Interval 427 , 486
 Update Path 427
 Update System Time from ISDN 132
 Update Timer 240
 Update URL 444
 UPnP Status 465
 UPnP TCP Port 465
 Upstream 174
 Uptime 124 , 499 , 501 , 502 , 503 ,
 504 , 505

URL 470
URL Path Depth 434
URL/IP-Address 439
Usage Area 194
Usage Type 273 , 284
Use Key 358
Use PFS Group 331
Use Zero Cookies 336
User name 256 , 261 , 266 , 271 , 278
 , 282 , 343 , 350 , 397 , 425 , 441 ,
 480

V

Value 498
Virtual Channel Connection (VCC)
 295 , 298
Virtual Channel Identifier (VCI) 290
Virtual Path Connection (VPC) 298
Virtual Path Identifier (VPI) 290
VLAN ID 185
VLAN Identifier 189
VLAN Members 189
VLAN Name 189

W

WDS Description 213 , 502 , 503
Weight of Age 202
Weight of Penalty 202
WEP Key 1 - 4 214
WEP Key 1-4 210 , 216
Whitelisted 439
Wildcard 426
Wire Mode 176
Wireless Mode 198
WMM 209
WPA Cipher 210 , 216
WPA Mode 210 , 216
WPA2 Cipher 210 , 216

X

X.31 (X.25 in D Channel) 164
X.31 TEI Service 164
X.31 TEI Value 164

X.75 Layer 2 Mode 169

Z

Zero Cookie Size 336