



elmeg T484

Operating instructions
English

Declaration of conformity and CE marks

This device meets the requirements of the following EC directive R&TTE 6/3/EG:



»Directive 1999/5/EC of the European Parliament and of the Council of 9 March 1999 on radio equipment and telecommunications terminal equipment and the mutual recognition of their conformity«.

You can also request this EC declaration of conformity at the following Internet URL: <http://www.bintec-elmeg.com>.



The waste container symbol with the "X" through it on the device indicates that the device must be disposed of separately from normal domestic waste at an appropriate waste disposal facility at the end of its useful service life. You will find additional information on an individual returning of the old appliances under www.bintec-elmeg.com.

© bintec elmeg GmbH - All rights reserved.

Reprinting of this document, even excerpts, is permitted only with the express consent of the publisher and with precise source information, regardless of the media used (mechanical or electronic).

Function descriptions included in this documentation which refer to software products of other manufacturers are based on the software used and valid at the date the documentation was prepared or published. The product and company names used in this documentation may be protected by trademarks.

Table of contents

Description	1
Safety notes	1
Important notes for using the PABX system	1
Cleaning	2
Loss of power.	2
Symbols	2
Features	6
Operation	10
Making phone calls.	10
Making outside calls	10
Specific trunk group seizure	11
Making internal calls.	11
Accepting calls	11
Accepting calls (Pick-up)	11
Automatic completion of call to busy subscriber or on no answer	12
Defining your own number for the next call	13
Temporarily suppressing transmission of your own number	13
Trunk group reservation.	13
Speed dialing from the telephone directory	13
Voice announcement	13
Announcement	14
Room monitoring	14
Malicious call identification (Tracing)	15
Allocating Project Numbers.	15
(keypad-function »Net fixed«)	16
Sending a fax from a multi-function terminal.	16
Direct dial-in	16
Room inquiry	16
Call waiting	17
Transferring calls with and without advance notice	18
(Explicit call transfer)	18
Broker's call.	19
Three-party conference	19
Call forwarding.	20
Silent signalling	20

Call modes (Day- / Night)	20
Teams	21
Activating the switching function for an internal subscriber	21
Follow me	21
Block dialing (Austria).	22
Wake-up call	23
Signaling features	24
Switching contacts	24
Modified code numbers	26
Communication / Call charges	26
System menu for the PABX	26
System telephones	27
Intercom.	27
Voicebox (Answering machine)	28
Voicebox system performance features	28
Connections to the Voicebox system.	29
Number of Voiceboxes and free recording time for each Voicebox.	29
Settings for a Voicebox	32
Using the Voicebox at a phone	32
Logging of calls	33
Using a Voicebox at an assigned phone	34
Procedure for entering the Voicebox menu	34
Use from any internal telephone	37
Remote control of Voicebox from an external phone	37
Configuring the Voicebox using a system phone.	38
Settings for the »Day« and »Night« modes	40
General settings.	41
Listen to messages	41
Commissioning the phone part	43
Configuring performance features using a telephone.	46
Service access	46
Setting features using a telephone	47
Commissioning an IP-phone for a DSP module	49
Initial startup	49
PABX and PC	51
Application programs	52
Drivers.	52
Configuration with a PC.	54

Description of the router functions	56
Appendix	64
Troubleshooting	64
Technical specifications	66
Brief description of functions	69
Quick Reference for Voicebox.	73
Index	75

Description

The PABX is an ISDN telecommunications system (PABX) for interfacing with the Euro ISDN (DSSI) protocol). The PABX system is equipped with an external ISDN port that is configured for connecting to the ISDN access point of the network service provider. You can set the ISDN port either as an internal or external ISDN port. You can program the type of connection for the external ISDN connection either as a multipoint connection or as a point-to-point connection (default setting). Depending on the type of PABX, up to eight (8) analog terminals can be connected (base model). You can use door intercom units as modules in the PABX system, or as additional devices at the internal analog port. Module slots for ISDN and a/b ports, contacts modules, 4 DSP modules and up to 4 analog access lines (POTS) are also provided. User-specific answering machines (voiceboxes) can be used after installing the optional Compact-Flash Card. Internal numbers (the destination for the extension number with point-to-point connection) between 0... 99 can be freely assigned. The features provided for analog terminals can only be used with terminals which use tone dialing and which are equipped with a flash button. Flash duration detection can be set by PC configuration.

Analog terminal devices that use pulse dialing can not be used for functions or codes. Please note that the buttons on some ISDN terminals available on the market may limit the use of the features provided by the PABX system. All terminal devices connected to the system must be »TC Terminals Guideline« or »R&TTE Guideline« approved.

The PABX system also provides all of the functions necessary for high-speed Internet access for a single pcs, or for complete LANs via xDSL or ISDN. Here the firewall integrated into the PABX system, together with the NAT (network address translation) function, provides the necessary security; the functions DHCP server and DNS proxy ensure that the scope of configuration, both for your PABX system and your PC, is kept to a minimum.

Internet access for all of the PCs connected to the PABX system is provided via one single connection (SUA - single user account); only one set of access data is required from your Internet service providers (ISP).

The CD supplied with this system contains other important documentation:

- Assembly instructions
- System telephones
- Description of functions
- Operating instructions for Voicebox

Note

For a description of the features please refer to the online help for the »Professional Configurator« or the user information on the CD.

Note

The first time you start the Configurator you will be asked to enter your user ID and password. Use »Service« as your user ID and also »Service« as the password. Please note that these words are case-sensitive! Once you've been logged on to the Configurator you can change your user ID and password as you like.

Safety notes

Important notes for using the PABX system

- Unauthorized opening of the PABX and improper repairs may result in risk of injury for the user.
- Unplug the 230 V AC connector plug before removing the enclosure cover and working on the cable terminal bay. Replace the cover before reconnecting the 230 V AC connector.
- Do not expose the inside of the PABX to any liquids; this would pose a risk of electrical shock. If you expose the inside of the PABX to liquids the PABX can be destroyed.
- You should not connect or disconnect any lines during thunderstorms.

- Only terminals with SELV and/or which comply with ETS 300047 may be connected to the PABX system. This regulation is fulfilled when approved terminal devices are used as intended.
- Find an appropriate installation location. The distance from the network termination (ISDN connection) of your service provider and the 230 V AC outlet should not exceed 1.5 meters.
- Water or heating pipes near the installation location can be used to install functional grounding. Ensure that these lines are connected to the grounding circuit connector of your house service connection.
- The PABX is powered by a 230 V AC utility outlet. Please ensure that the electrical outlet (grounding outlet) for the PABX (and for additional devices where required) is installed such that it is freely accessible at all times and that it is installed by a qualified electrician to prevent any risks of personal or material injury/damage! Where at all possible, provide a separate power circuit for the 230 V AC connection of your PABX system. This protects your PABX from short-circuits that may occur in other in-house equipment.
- We recommend installing an overload protection to protect your PABX against surge that can sometimes occur during thunderstorms. For further information please contact your local electrician.
- To prevent mutual interference, do not install your PABX system in the immediate vicinity of electronic devices such as stereo equipment, electronic office equipment or microwave units. Avoid installing your PABX near sources of excessive heat, e.g. radiators or in rooms with excessive humidity.
The ambient temperature must not exceed 40° C.

Cleaning

Please observe the following points: You can clean your PABX without any difficulties. Use a slightly moistened cloth or an anti-static cloth for this. Do not use any solvents! Never use a dry cloth; Electrostatic charges could damage the electronics in the system. Always ensure, however, that no moisture penetrates into your PABX, as this could result in damage to the PABX.

Loss of power

On loss of power (230 V AC power supply) the PABX is not operational, meaning that you can make neither internal nor external calls. An ISDN terminal device with emergency power capabilities can continue to be operated however.







On return of power, functions which have been configured by the user, e. g. internal and external connections, are not active. The features configured using setup programming are unaffected by a loss of power.

Symbols

Please note: Different terminal devices will not necessarily have the same dial tones, ringing signals or procedures for use.

For further information on clock frequency and length, please refer to the assembly instructions.

Symbols used

- | | |
|--|--|
|  | Lift up the handset of your telephone. |
|  | This symbol indicates the call status. You have lifted the handset of your telephone. |
|  | Replace the handset of your phone in the carriage, or the telephone is idle. |
|  | Indicates signaling at a terminal device, for example your phone rings. |
|  | You can dial the desired number. |
|  | One of these symbols indicates that you should dial the digit shown, or a certain character. |
|  | |

0 ... 9 *	These symbols indicate a selection of digits or characters from which you can choose the appropriate one.
X	This symbol prompts you to select a certain digit or character from a list or table.
R	Prompts you to press the flash key (signal key).
☒	Indicates that an acknowledgement signal can be heard in the handset.
✳	Indicates a conference call.
#	When you enter the number for dialing via an SIP provider, dialing is not performed until around 5 seconds after the last digit has been entered. Dialing is performed immediately when you press the # key after entering the number. In this case, the terminal device must also be capable of dialing into the phone system with the #.

Supported Features

The following ISDN features are supported by the PABX system at the exchange of the network service provider; some of these may have to be applied for at your service provider.

- CD: Call deflection (forwarding of calls)
- PR: Partial Rerouting. Individual call forwarding for terminal devices at a point-to-point connection
- CLIP / CLIR: Activation/Deactivation of caller ID to party being called.
- COLP / COLR: Activation/Deactivation of called party ID to caller.
- AOCD: Transmission of charge costs during a call.
- AOCE: Transmission of costs of call at end of call.
- AOCS: Transfer of tariff information during the calling phase, for example for pay phones.
- CCBS: Completion of call to busy subscriber, as soon as subscriber is available.
- CCNR: Call-back to available subscriber as soon as that party has lifted and replaced the handset.
- MCID: Malicious caller ID (tracing).
- CFB / CFU / CFNR: Call forwarding.
- UUS1: Transmission of user-defined text messages.
- SUB: Extended addressing for a terminal device.
- X.31: Support for packet data (V-25) on the D-channel, for example for electronic cashiers.
- SMS in the fixed-line network.

Note

Please note that some of the features described in these operating manual must be applied for at your service provider.

Display / LEDs**Note**

You can de-activate all of the LEDs except for »Power / On« and »LAN« in the configuration of the PABX system.

Power / Operation	Ready for operation indicator. Green lit: When the PABX is ready for operation. Green flashing: When 480 data records have been saved in the charges memory of the PABX
ISDN / POTS	Indicates the allocation of each B channel for the external ISDN connection. Green lit: ISDN port ready for operation or POTS-module plugged in Green flashing: One B channel busy, or an existing connection via the POTS module Green flickering: Two B-channels busy
DSL	Indicates the function of the DSL router: Green lit: DSL connection established Green flashing: Data link established
LAN	Indicates the network connection status: Green lit: 100Mbit/s network connection established Green flickering: 100Mbit/s data link Orange lit: 10Mbit/s network connection established Orange flickering: 10Mbit/s data link Red flickering: Network link collision
USB	Indicates the status / activities on the USB port. Not lit: The USB port of the PABX system is not ready for operation at the connected PC (not logged in, or not recognized), or when the PC/USB port is in the suspended mode. Green lit: The USB port of the PABX system is ready for operation at the connected PC (USB driver active). PC applications that run via the USB connection can be started. Green flickering: Data is being exchanged via the USB port. For ex.: CAPI application programs, CTI applications or new software download into PABX system.
CF-Card	Indicates that a Compact-Flash Card has been plugged in: Green lit: CF-Card plugged in Green flickering: Data being transferred to the CF-Card

Note

Refer to »Voicebox operating instructions« on the CD for further information about using the Voicebox. Voicebox«.

All LEDs lit

New firmware not properly identified by the PABX. Please repeat the operation.

All LEDs flashing

New firmware being downloaded into the PABX. Do not remove the plug-in power supply unit for the PABX system during this phase, as it can result in data being lost in the PABX.

Features

Examples of the features and functions supported / offered by your PABX system are listed below. Detailed information and description of functions can be found on the CD-ROM.

- Transfer of calls to a specific team or extension
- Analog exchange line ports (POTS)
- Changeable access codes
- Call waiting
- Answering machine (analog or ISDN device) connectable
- Call modes (day/night call modes)
- Call forwarding (Call rerouting) continuous, on busy or on no answer
- Remote programming of call forwarding
- Reading and deleting a call forwarding (internal / external)
- Call deflection during an ongoing call (CD – Call Deflection)
- Announcement device
- Voice announcement before answering
- Connections for terminal devices (analog, ISDN), PC and Modules
- Programming direct exchange line access separately for each extension
- Automatic completion of call to busy subscriber or on no answer
- User to User Signaling 1 UUS1
- Block dialing (for analog terminal devices only)
- Trunk group seizure for external ISDN connections
- Trunk group seizure programmable for each internal subscriber
- Reserving a trunk group (ISDN connection)
- CCNR per subscriber
- Data records for coupled calls
- Setting the date and the time
- Accepting date and time from the exchange
- Dialer protection (Unrestricted data)
- Direct dial-in
- Three-party conference call
- Enable messaging function and message reception separately for each internal extension
- Programming terminal devices for analog connections
- Extended call allocation with point-to-point access

- External line access digit for caller list
- Remote control for remote call forwarding, room monitor, door opener and switching contacts
- Remote access protected by PIN2 (6-place) of the PABX
- Malicious caller ID (tracing / MCID – Malicious Call Identification)
- Follow me
- Gateway external for ISDN, internal for analog connection
- Meter pulse for analog connections (12 kHz or 16 kHz)
- Transferring calls with or without prior notice (switching)
- Storing communication costs and call data records
- Communication cost display and charge counter of internal terminal devices
- Call cost account (cost limit, allowance account)
- Call pick-up (Pick up)
- Picking up calls from an answering machine
- Picking up calls for a specific subscriber
- Keeping ISDN layer 2 permanently active for each external ISDN connection
- Calendar (2 calendars with 4 switching times per week day and holiday)
- Changing code numbers for specific features
- Keypad functions (net direct)
- Support for multifunctional devices at the analog ports
- PABX-configuration over ISDN or USB, LAN-port
- Configuration of system features using a telephone
- Programming access to the PABX protected by PIN 1 (4-place)
- Cost conversion factor
- Country-specific parameters can be set
- Least Cost Routing (LCR) including support of gateways
- Broker`s call
- Signaling features
- PABX extension modules
- Assignment of names in the PABX system for subscribers, teams and connections
- Loss of power: Emergency operation possible
- Emergency call numbers in the PABX (6 numbers)
- Programming of emergency telephones
- Data packet transfer (X. 31)

- Parking (TP - Terminal Portability) at the internal ISDN port
- PC-connections (USB, LAN) for configuration
- PIN (password) required for accessing the PABX
- Project numbers / client numbers
- Room monitoring from internal and external terminals
- Routing discrimination
- Router inhibition
- Inquiry call
- System-parked inquiry call
- Number identification (NI) possible for internal subscribers
- Assigning telephone numbers for external calls separately for each internal subscriber
- Defining your own number for the next call
- Disable calling line identification (setting in the exchange)
- Disable calling line identification (subscriber-specific setting in the PABX)
- Temporarily suppressing transmission of your own number
- Variable AC ringing voltage for analog connections (25 Hz or 50 Hz)
- Station guarding (do not disturb)
- Call signaling (group ringing: simultaneous, linear, rotating, adding, linear / rotating or simultaneous on no response).
- Switching contacts available on the doorphone module and the switching contact module
- Internal or external activation of switching contacts
- Protection of data link
- Service access (remote configuration, remote maintenance, software downloads)
- SIP-telephony over DSP-module
- SMS (short messages), enable SMS reception separately for each internal subscriber
- Automatic setting of winter and summer time
- Sub-addressing
- System menu for the PABX
- System telephones
- Configuring system telephones through the PABX
- Call modes for teams
- Telephone directory / speed dialing from the telephone directory
- Telephone interlock



- Appointment call / morning call
- PABX can be used at point-to-point or point-to-multipoint access (also mixed)
- Door intercom device (door terminal module) connectable via door intercom module
- Door intercom adapter connectable
- Switching calls to a busy subscriber
- Switching functions
- Voice applications for music on hold, morning call announcements or Voice announcement before answering
- Call authorization (access to the public telecommunications network)
- Switching call authorizations (for external calls) automatically
- Dialing control (barred numbers: 10 numbers / Unrestricted numbers: 60 numbers)
- Calling method configurable for analog terminal devices (DTMF with flash or pulse dialing)
- Music on Hold, internal or voice applications
- Intercom, intercom call reception separately configurable for each internal subscriber
- Central / second bell

Operation

Note

For a description of the features please refer to the Description of functions on the CD.

Not all of the features described here may be implemented in the standard ISDN connection supplied by your network service provider. Contact your service provider to determine which features come standard with your ISDN access and which ones you must apply for separately.

If your phone is set for »Automatic line access« you must first press the  key when you lift the handset before beginning any internal call procedures. The symbol  is highlighted in color, as shown in the example below, for the corresponding performance feature.



Making phone calls

Some terminal devices use their own special procedures for the functions described in the following. Refer to the operating instructions for the terminal device being used for detailed information.

Only telephone connections, i. e. calls between subscribers, are presented in the following usage procedures as examples. For analog telephones, these functions are only described for tone dialing terminal devices equipped with a flash key. The tones and signals described below are heard when using analog telephones. These tones may be different for ISDN telephones and analog telephones which generate their own dial tones. Other information may also be shown in the display of these telephones.

Note

Please note: ISDN terminal devices connected to the ISDN connection may not have the same signals, ringing cycles or operating procedures as the internal terminal devices for the PABX system.

Making outside calls

Making external calls without direct exchange line access

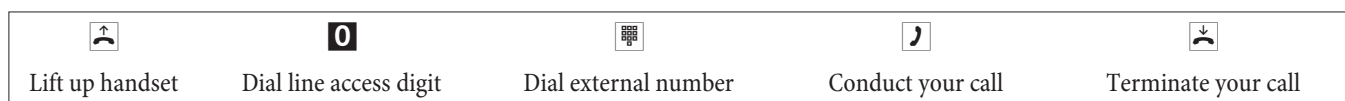



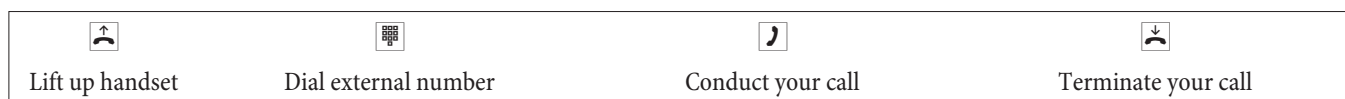

Note

If you hear the busy signal after dialing the first 0 your telephone either does not have authorization for making external calls, or the external ISDN connection is busy.

Making outside calls with direct exchange line access



Specific trunk group seizure

	* 8	or	* 8 #			
Lift up handset	Select trunk group ISDN, POTS(0...4)		Select trunk group ISDN, POTS, SIP-Prov. (00...04), (10...19)	Dial external number	Conversation	

Making internal calls

All phone calls, fax transmissions or data transmissions that take place between internal analog and ISDN terminal devices are internal connections for which no charges are billed.

Making internal calls without »Direct exchange line access«

			
Lift up handset	Dial internal extension number	Conversation	Terminate your call

Making internal calls with »Direct exchange line access«

	*			
Lift up handset		Dial internal extension number	Conversation	Terminate your call

Accepting calls

			
Telephone rings	Lift up handset	Conversation	Terminate your call

Accepting calls (Pick-up)

Picking up calls from within the group



Note

Picking up a call is possible only within the pick-up group to which your terminal device has been assigned via configuration.

A telephone near you begins ringing. You would like to accept the call at your own phone.

	* 0	
Lift up handset	Accept call	Conversation

Picking up calls from the answering machine

	* 0 / # 0	
Lift up handset	Take call / conversation from the answering machine	Conversation

Picking up calls for a specific subscriber

Picking up of calls for a specific subscriber applies to the entire pbx system and is not bound to groups.

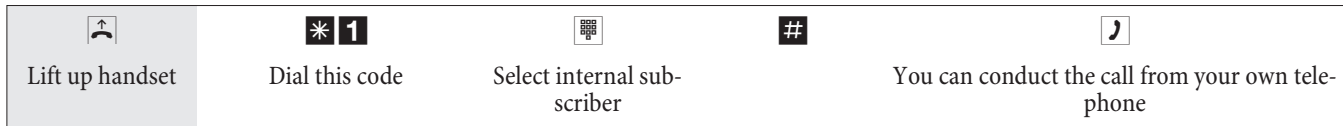

Telephone interlock

Use this feature to download configured characteristics for outgoing calls into another phone. This includes trunk group seizure, authorizations etc. All charges will be billed to your own phone. If possible, the called party sees the number or name in the display of his or her phone. This applies also to an inquiry call. During configuration, a PIN is allocated to each subscriber.

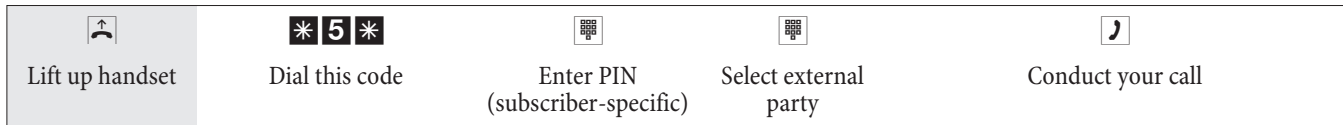

Automatic completion of call to busy subscriber or on no answer

This function can only be used by telephones that permit suffix dialing. Automatic call completions from an inquiry call are not possible.

Note

External Completions of call to busy subscriber are deleted after a period defined by the exchange.

Programming »Completion of call« for analog telephones



When the subscriber that was called hangs up his/her handset your telephone will ring. When you lift up your handset the subscriber for which completion of call is active is called. If the party answers you can conduct your call.

Programming »Completion of call on busy« for ISDN telephones

This feature is supported for ISDN telephones by the PABX at the internal ISDN connection. Please refer to the operating instructions for your ISDN telephone for proper use.

Programming »Completion of call on no answer« for ISDN telephones

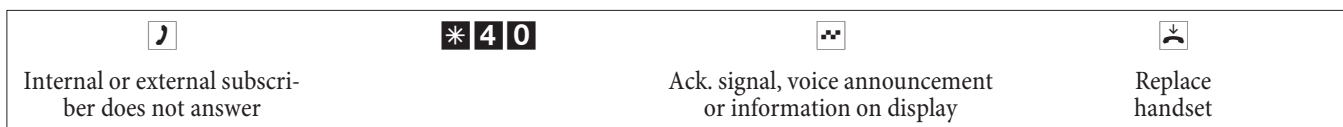

When the subscriber that was called hangs up his/her handset your telephone will ring. When you lift up your handset the subscriber for which completion of call is active is called. If the party answers you can conduct your call.

Canceling automatic completion of call for analog telephones

Analog telephones use this procedure for canceling internal completions of call to busy subscriber and no answer.

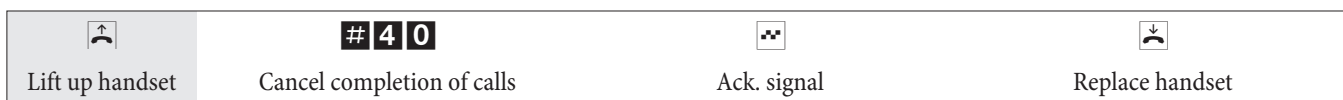

Deleting an automatic »Completion of Call on No Answer« with ISDN phones

Internal completion of calls on no reply is canceled with ISDN telephones using the following procedure.

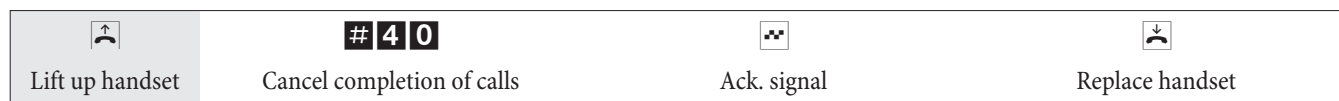

Defining your own number for the next call

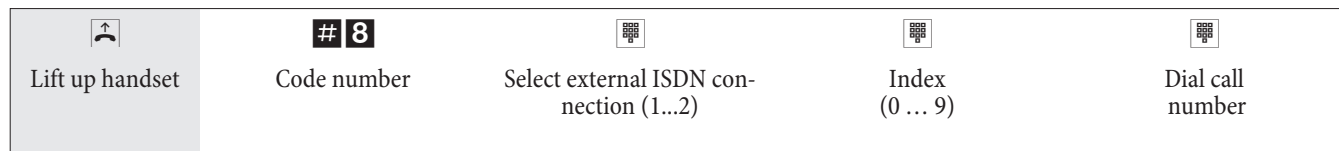

Temporarily suppressing transmission of your own number

Note

This feature must be applied for at your network service provider.

Transmission of the caller's own number is suppressed using the following procedure with analog terminal devices. Please refer to the operating instructions for ISDN terminal devices on how to initiate this feature.



Trunk group reservation

Neither for IP-phones nor trunk groups with SIP-providers.

Activating trunk group reservation

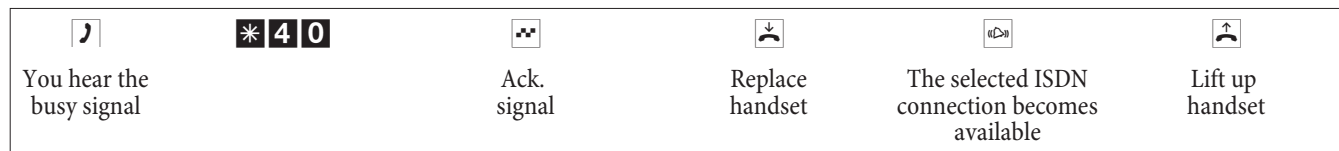

Deleting trunk group reservation







Speed dialing from the telephone directory



Voice announcement





Note
A voice announcement extension can be reached by internal extensions only.

 Lift up handset	 Internal number for the voice announcement extension	 Voice announcement	 Terminate voice announcement
---	--	--	--

Announcement

Refer to the operating instructions for your telephones whether the phones support the message feature.

Making an announcement

 Lift up handset	 * 5 4 0	 Internal number or team number	 Ack. signal	 Announcement
---	---	--	--	--

Enabling / inhibiting announcements

You can enable or inhibit the sending of messages to your telephone. If you have disabled messages being sent to your phone, the caller that is attempting to send a message to you will hear the busy signal.

 Lift up handset	 * / #	 5 9 1	 Ack. signal	 Replace handset
---	---	---	--	---

Room monitoring



This feature can not be used in conjunction with inquiry call, call forwarding or team call functions.

Note
Room monitoring is deactivated after each pabx configuration and must subsequently be enabled and configured once again.

Enabling room monitoring for an internal telephone

 Lift up handset	 * 5 9 3	 Ack. signal	Do not replace handset /Do not deactivate hands-free calling
---	---	---	--

Room monitoring from an internal telephone

 Lift up handset	 Dial the number of the telephone to be used for room monitoring	 Ack. signal	Room monitoring is activated
---	---	---	------------------------------

Room monitoring from external telephones

You are located at an external telephone.

Lift up the handset of the phone from which you wish to conduct room monitoring and dial the external number to which the service number for the PABX is assigned.

If remote access has been enabled and is possible at this time you will hear the special dial tone of your PABX. Set your phone to frequency (DTMF) dialing, or use a DTMF manual transmitter.



To end room monitoring, hang up the handset of the external telephone.

Malicious call identification (Tracing)



Note

Attention: Only hang up the handset after you have entered the code for tracing the caller and hear the positive acknowledgement signal.

Allocating Project Numbers

Assigning a project number for a call you initiate

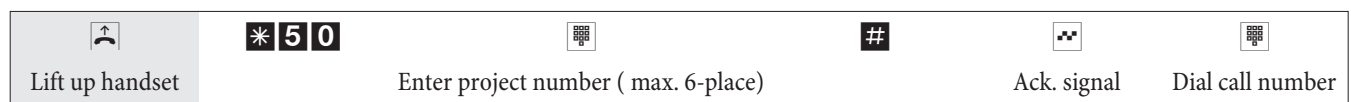

Project number for incoming external call to ISDN terminal device

You can use this feature at an ISDN terminal if your ISDN terminal device supports the function »Network Direct« (keypad).

You are conducting a call and wish to register it for a project.

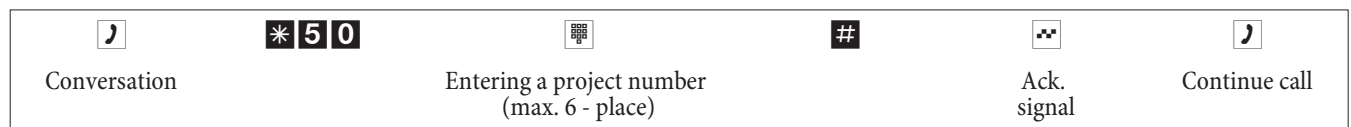

Project number for an external call

You can use this feature at an analog or an ISDN terminal device if your ISDN terminal does not support the function »Net direct« (Keypad) during an ongoing call.

You are conducting a call and wish to register it for a project.

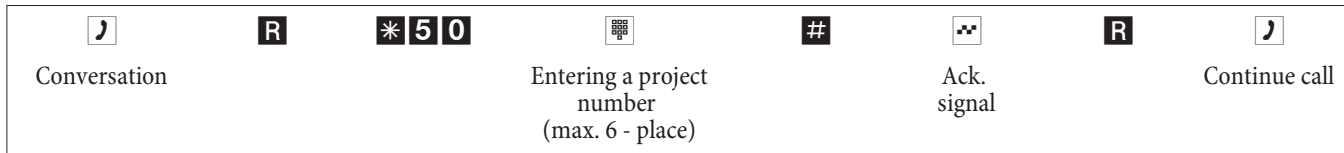

(keypad-function »Net fixed«)

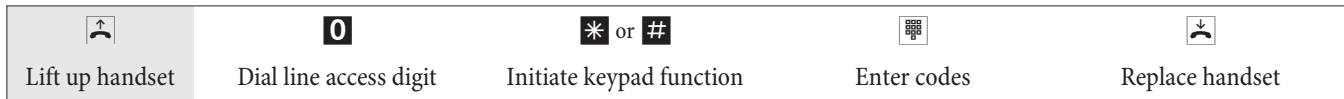

Sending a fax from a multi-function terminal

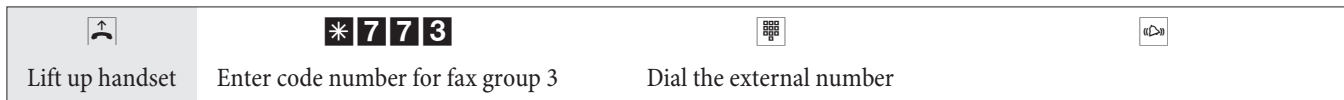

Direct dial-in

Making telephone calls with activated direct dial-in



Entering and activating a direct call number

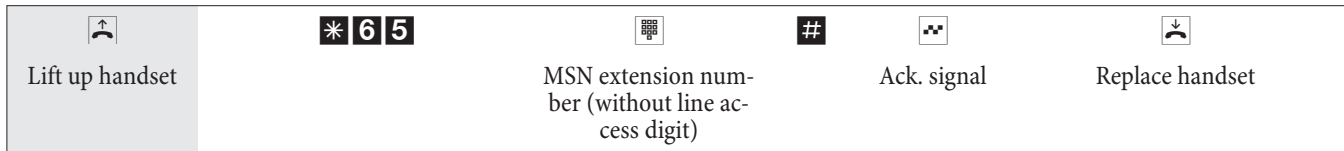

Note

Now, when you lift up your handset the direct call number will be dialed after the specified time (default setting: 5 seconds).

Activate/deactivate direct dial-in



The numbers stored in the PABX for direct calls are retained even when the direct call function is deactivated.

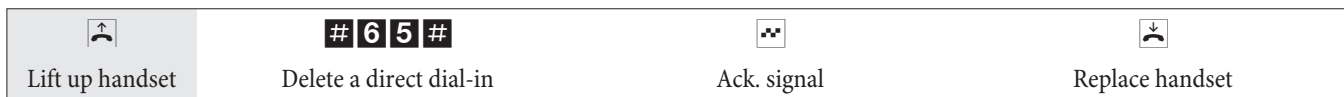

Deleting a direct dial-in number (phone number)





The stored direct dial-in number is deleted.



Room inquiry

You can call another party at any time during an ongoing call.





-  You are conducting a call.
You would like to call another party.
 -  Press the R key.
You will hear the internal dial tone.
 -  If you wish to speak to an external party, dial 0 first.

If you hear a busy signal after dialing 0, either your telephone does not have proper authorization for an external call, or the line is busy.
 -  Dial the number of the party you wish to call.
You will hear the ringing signal in your handset.



The party will be called.
The party being called lifts up the handset of his/her phone.
 -  Conduct your call.

To end the inquiry call press the Disconnect key on your ISDN phone.
- or
- With analog telephones:
-  The connection put on hold is terminated. The active connection remains.
 -  The active connection is terminated and you return to the call that was previously put on hold.
 -  Continue with your call.

Initiating a system parked inquiry

-  You are conducting an external call. You want to make this call available for a system-parked inquiry.
-  Press the R key. You will hear the internal dial tone.
-  Dial any one of the 4 configured internal system parked inquiry numbers or the fixed code *596. You will hear the positive acknowledgement signal.
-  If you hear the busy tone, dial the next configured internal extension number
-  Replace the handset, the external call is put on hold in the waiting loop.

Accepting a system-parked inquiry

-  You wish to accept the call from a system-parked inquiry.
-  Dial any one of the 4 configured internal system parked inquiry numbers or the fixed code *596.
-  You have accepted the call.

Call waiting

During an ongoing call you can accept, or refuse, a waiting call at any time.

Enable / Inhibit Call Waiting for a Further Call





 Lift up handset	 enable / inhibit	 Ack. signal	 Replace handset
--	---	--	--

Accepting a waiting call (room inquiry with waiting caller)

-  You are conducting a call.
A second party calls you.
You hear the call waiting signal.

- R 2** Dial this code.
-  You will be connected with the waiting party. Your first call is put on hold (see »Inquiry call«). For further procedures refer also to »Broker's call« or »Three-party conference call«.

Accepting a waiting call

-  You are conducting a call. You hear the call waiting signal.
-  Replace handset (your first call is terminated).
-  Your phone rings.
-  Lift up the handset of your phone. You will be connected with the waiting party.



Refusing a waiting call

-  You are conducting a call.
A second party calls you.
You hear the call waiting signal.
- R 0** Dial the code for refusing the waiting call. The caller can be switched to the waiting queue, or the call is established and the caller will hear the busy signal.

Transferring calls with and without advance notice



Transferring calls internally without advance notice

You can transfer calls when you dial the number of the internal party and then hang up the handset. The internal party is then called and can take the call when he/she lifts the handset.

-  You are conducting an external call.
- R** Press the R key.
You will hear the internal dial tone.
-  Dial the number of the internal party to whom you wish to transfer the call.
You will hear the ringing signal in your handset.
The party will be called.
If you hear the busy signal press the R key again to retrieve the call that is on hold.
-  Replace the handset. The party will be called. The party being called lifts up the handset and conducts the external call. If the called party does not lift up his/her handset you will be called back at your telephone after a time interval set during programming.

Transferring calls with advance notice

You wish to transfer an internal or external call to another internal party and speak with that party beforehand.

-  You are conducting an internal or external call. You wish to transfer the call to another party.
- R** Press the R key. You will hear the internal dial tone.
If you hear the busy signal, press the R key again to retrieve the call.
-  Dial the number of the party you wish to call.
You will hear the ringing signal in your handset.
The party will be called.
The party being called lifts up the handset of his/her phone.
-  Conduct this internal call.
Tell your internal partner that you wish to transfer the call currently on hold to him/her.



Replace the handset.

The other internal party can then continue with the call.

(Explicit call transfer)

Connecting

Please note that ISDN terminal devices can only utilize the feature »Connect« via a special key or menu function. The following procedure applies only to analog telephones.



You are conducting a call with party 1.
A further call is signaled, for example by call waiting.



Dial this code.
Party 2 answers; you can speak with Party 2 Party 1 is put on hold.



You would like to connect the two parties with one another.
Dial this code.

The two parties are then connected. The charges for the connection are billed to the party who established the connection.

Broker's call



You are conducting a call and wish to speak to a further party, without the first caller being able to hear your conversation with the second caller.



Press the R key.
You will hear the internal dial tone.



If you wish to speak to an external party, dial **0** first.
Dial the number of the party you wish to call.
You will hear the ringing signal in your handset.
The party will be called.
The party being called lifts up the handset of his/her phone.



You are conducting the call.
The first call is put on hold.



Dial this code to return to your first caller; the second party is put on hold. You can then use this code to switch back and forth between the two callers.

or



You can end the call that is on hold.
Dial this code.

or



You can end the current call.
Dial this code.





If you switch back and forth between an internal caller and an external party (broker's call) and then hang up your handset, your call is terminated and the two callers will be connected with one another!

If you switch back and forth between two external parties (broker's call) and then hang up your handset, the current call is terminated and the caller on hold will call you by way of the »Recall«.

If, during a broker's call, you press the R key and then dial 4, the two external parties are connected with one another and your call with both of the external parties is terminated. The charges for the call that you initiated will be billed to you.

Three-party conference

-  You are conducting a call with one party and wish to include a further party in the call.
- R** Press the R key.
You will hear the internal dial tone.





If you wish to speak to an external party, dial 0 first.
-  Dial the number of the party you wish to call.
You will hear the ringing signal in your handset. The party will be called.
The party being called lifts up the handset of his/her phone.
-  You would like to include this party in the first call.
- R 3** Dial this code.
-  Conduct your three-party conference call.
-  You would now like to exclude the party that you first brought into the conference call from further conversation. This caller then remains on hold in an inquiry call.
- R 2** Dial this code.
-  You can then continue your call with the second party. The first party is on hold.

The conference is ended when you hang up your handset. A party included in the conference call can hang up at any time and the party which initiated the call can then continue the conference with the remaining callers.



Call forwarding

Note
The PABX recognizes automatically by the length of the number whether call forwarding is to be made to an internal or external subscriber. This is why the destination number for call forwarding to an external subscriber is always input without the line access digit (LAD).

Activating call forwarding



	*	6 1 / 6 2 / 6 3		#		
Lift up handset		Permanent call forwarding / Call forwarding on no reply / Call forwarding on busy	Destination number for call forwarding (without line access digit)		Ack. signal	Replace handset

Deactivating call forwarding

	#	6 1 / 6 2 / 6 3		
Lift up handset		Permanent call forwarding / Call forwarding on no reply / Call forwarding on busy	Ack. signal	Replace handset

Silent signalling

Deactivating call signaling for analog terminal devices





 Lift up handset	* 5 7	0 / 1 / 2 internal + external calls / only external calls / only internal calls	 Ack. signal	 Replace handset
---	--------------	---	---	---

Activating call signaling for analog terminal devices

 Lift up handset	# 5 7 0		 Ack. signal	 Replace handset
---	----------------	--	---	---

Call modes (Day- / Night)

Activating team call assignment for one team

 Lift up handset	* / # Day / Night call mode	9 3	 Enter team number (00...19)	 Ack. signal	 Replace handset
---	---------------------------------------	------------	---	---	---

Switching team call assignment for all teams

 Lift up handset	* / # Day / Night call mode	9 3 *	 Ack. signal	 Replace handset
--	---------------------------------------	--------------	--	--

door terminal (door intercom device) - Switching call modes for a doorbell button

 Lift up handset	* / # Day / Night call mode	9 6	1 select door terminal	 Select bell button (1...4)	 Ack. signal	 Replace handset
---	---------------------------------------	------------	----------------------------------	--	---	---

door terminal (door intercom device) - Switching call modes for all door terminal modules

 Lift up handset	* / # Day / Night call mode	9 6 *		 Ack. signal	 Replace handset
---	---------------------------------------	--------------	--	---	---





Switching all call modes (all teams and door terminal modules).

 Lift up handset	* / # Day / Night call mode	9 *		 Ack. signal	 Replace handset
---	---------------------------------------	------------	--	---	---

Teams

Enabling / Inhibiting a subscriber of a team (log-in, log-off)

Proceed as follows in order to enable or inhibit your phone for a team

 Lift up handset	 Subscriber enable/inhibit	9 4 3	 Team number (00 ... 19)	 Ack. signal	 Replace handset
---	---	--------------	---	---	---

Enabling / inhibiting a subscriber for all teams (log-in, log-off)

Proceed as follows in order to enable or inhibit your phone for all teams.







 Lift up handset	 Enable/Inhibit subscribers	9 4 3 *	 Ack. signal	 Replace handset
---	--	----------------	--	---

Activating the switching function for an internal subscriber

 Lift up handset	 Activate day mode / night mode	9 1	 Code	 Ack. signal	 Replace handset
---	--	------------	--	--	---

Follow me

Setting up or deleting an internal Follow me









 Lift up handset	 Set up / delete	6 4	 Follow me *1)		 Ack. signal	 Replace handset
---	---	------------	---	---	---	---

*1) Internal number whose calls are to be forwarded. Call will then be forwarded to the specified telephone.

Setting up /deleting call forwarding from an external location

Lift up the handset of your phone and dial the external number to which the service number of the PABX system has been assigned.

If remote activation of call forwarding has been enabled you will hear the special dial tone for your PABX system. Set your phone to DTMF dialing:

 Enter PIN 2	 Ack. signal	 Set up	6 4	 *1)	 Set up	 *2)		 Ack. signal
---	---	--	------------	---	--	---	---	---

 Enter PIN 2	 Ack. signal	 Delete	6 4	 *1)		 Ack. signal
---	---	--	------------	---	---	---

*1) Internal number whose calls are to be forwarded.

*2) Destination number for call forwarding (outside number without LAD).

You will then hear the positive acknowledgement signal for about 1 second; the connection is then terminated and you will hear the busy signal. Replace the handset.

Block dialing (Austria)

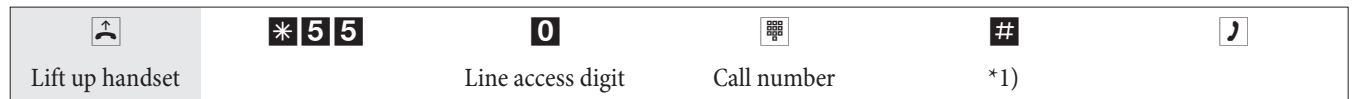

*1) Begin dialing by pressing the # key. Only now is the call transferred to the exchange.

Call Through

This action may only be performed from an external phone.

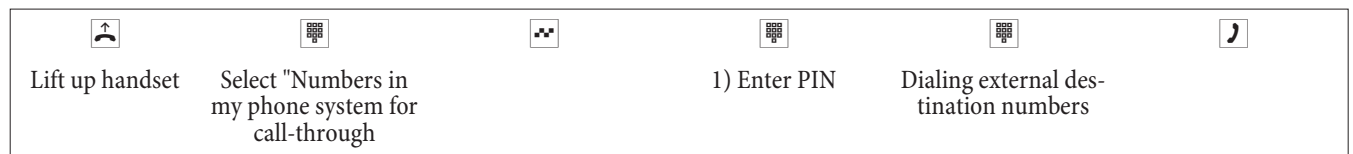

1) The configuration of the PABX system is decisive for this input (with or without PIN, with number recognition, or both).

Least Cost Routing (LCR)

Please note that there are some providers whose services must be applied for. Some of these providers automatically set up a connection to enroll unregistered customers. If you terminate such a connection during dialing and then subsequently attempt to set up this link again, this may result in errors during calling (communication will not be established). In this case it will be necessary to deactivate the provider concerned in the LCR professional on the WIN-Tools CD and to update the date records in the PABX.

You can activate/de-activate the LCR procedure using either the »Professional Configurator«, or a code sequence on the telephone.

Activating the LCR procedure

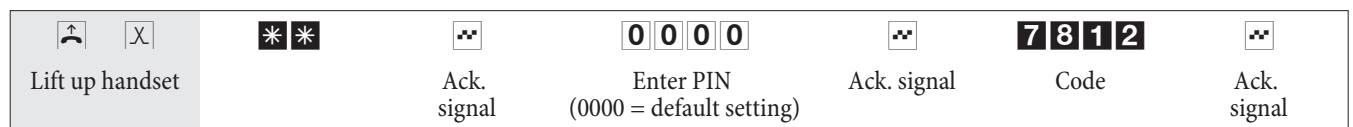

Deactivating the LCR procedure

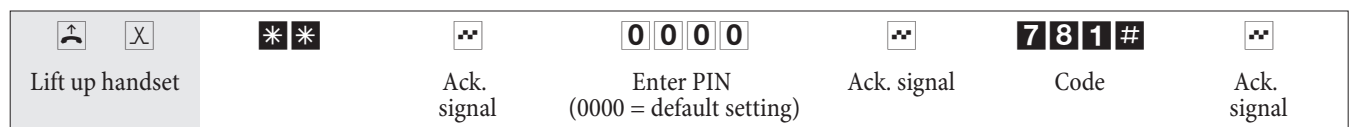

Wake-up call

Configuring wake-up calls from the room phone (one-time morning call)



0 6 Enter the hour desired for the morning call between 00 and 23 (in this example 6 am).

3 0 Enter the minute for the morning call between 00 and 59 (in this example 6.30 am)

Canceling a wake-up call

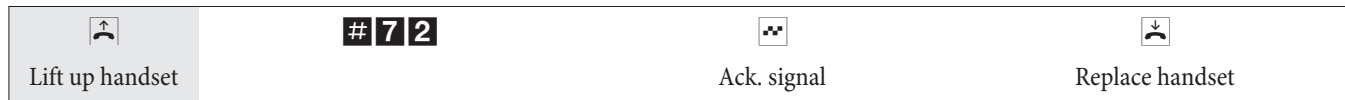

Configuring a wake-up call from the »Reception desk phone«

In addition to configuring wake-up calls using the room phone, wake-up calls can also be defined for several days in advance from the »Reception desk phone« (system feature).

Answering a morning call

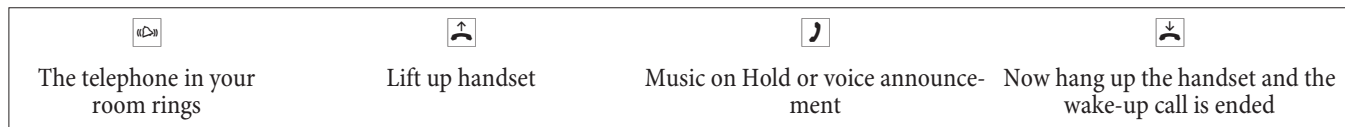

Door intercom device

Making a door interphone call / Opening the door



Activating the door opener



Note:

If a door entry phone call is signaled at a different telephone or if you hear the door bell ring, you can dial the door intercom phone number and pick up the door entry phone call yourself, provided you have the corresponding rights to do so.

Opening the door with ISDN telephones that do not support suffix dialing:





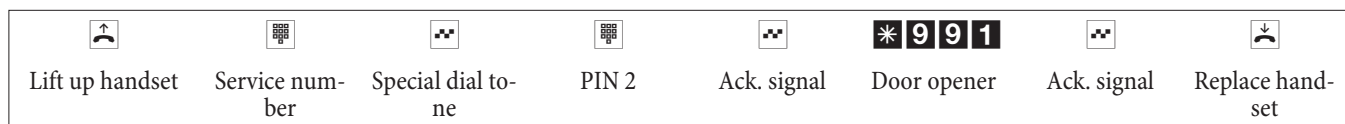

If you wish to open the door, terminate the door entry phone call and replace Lift up the handset again and dial *** 9 9 1** to open the door.

Actuating the door terminal externally



Signaling features

Activating/ de-activating alarm call feature

 Lift up handset	 9 5	 Alarm call list 01 ... 06	 function 0...2	 Ack. signal	 Replace handset
---	--	--	---	---	---

Alarm call list

The terminal device must have been entered into the list during configuration:

01 ... 06 Alarm call list 01...06.

Function:

- 0** Deactivating the alarm call feature.
- 1** Activating the internal alarm call feature.
- 2** Activate external call feature.

Switching contacts

Note

In the event of a loss of power and after a reset the switching contacts are idle.

Activating/ de-activating switching contacts

 Lift up handset	 9 7 0	 Switching contact01...03	 Ack. signal	 Replacehandset
---	--	--	---	--

Switching contact with button function

 Lift up handset	 9 7 1	 Switching contact 01...03	 Ack. signal	 Replace handset
---	--	---	---	---

The switching contact closes for the time interval you have programmed (1 ... 999 seconds).

Switching contact with a switch function (remote)

 Lift up handset	 Service number	 Special dial tone	 PIN 2	 Ack. signal	...
---	--	---	---	---	-----

...	 9 7 0	 Switching contact 01...03	 Ack. signal	 Replace handset
-----	--	---	---	---

Switching contact with a button function (remote)



 Lift up handset	 Service number	 Special dial tone	 PIN 2	 Ack. signal	...
---	--	---	---	---	-----

...	* 9 7 1			
		Switching contact 01...03	Ack. signal	Replace handset

The switching contact closes for the time interval you have programmed (1 ... 999 seconds).

Terminating an Internet connection from the phone

Using a corresponding operating procedure you can terminate an ongoing Internet connection from any phone.

	# 6 6 #		
Lift up handset	Disconnect Internet connection	Ack. signal	Replace handset

Modified code numbers

You can program your PABX with individual code numbers for the following features. Customizing the default PABX numeric code adds an extension from the internal telephone number plan of the system.

Enter all changed code numbers in the table. Various code numbers can be entered for the »System-parked inquiry« feature.

Feature	Default code number	Changed code number
Line access digit	0 (UK 9)	
System parked inquiry (four codes)	* 5 9 6	

The operation principle of the features whose code number has been changed remains as described. You can either use the changed code number (internal extension number) or the code number given in the operating instructions (except for the line access digit).

Communication / Call charges

The PABX generates a call data record for every external call. The call data records contain detailed information about the call.

For ex.: Date and time, duration of the call, number of the called party, number of the calling party, type of connection, communication costs and possible project numbers.

Incoming calls can be logged in two different ways.

- Only incoming calls with a certain project number are stored.
- All incoming calls are stored.

Output of call data records

You have two options to output the stored call data records. For example:

- Internal ISDN connection
- USB/LAN-connection

Communication cost display

The communication / call charges can be displayed at any terminal devices that support this feature. ISDN and analog terminal devices use different methods for transmitting and displaying communication costs.

Charge counter

The PABX manages a charge counter for each internal user on the basis of the transmitted charge rate information. The counter logs the costs of all calls. If your network service provider has made this rate information available on your ISDN connection then the PABX terminal devices can display this information. You can also reset the counters.

Charge limitation (Charge limit, pocket money account)

A call charge account can be programmed for each internal user. The charge rate amounts available to that particular user are defined in this account. If the user uses up his/her allotted units he/she can then only make internal calls. If this limit is reached during an ongoing call, the call can be completed. The user can make external calls again when the number of units on his/her account is increased or the counter is deleted.

System menu for the PABX

A special menu containing functions typical for the system is provided by the PABX. This menu, and the associated features, are managed solely from the PABX.

The following features are available in the system menu (Example):

Telephone directory for the PABX, Follow me, direct dial-in, Day / Night switching (call modes), cost registration, LCR, Voicebox.

You can select the language of your display, provided the desired language has been configured using the telephone directory programme.

Refer to the operating instructions of the system telephone being used to find out how to reach the PABX system menu.

System telephones

Various elmeg system telephones can be connected to the internal ISDN ports of your PABX, which automatically detects these phones and The PABX provides the system phones with the system menu and further specific features. System phones and (optional) supplementary keyboards can be programd with function keys. The system telephone operating instructions include a description of these functions and their configuration and use.

Intercom

Intercom calls can be placed to system telephones and to elmeg ISDN telephones.

If an intercom call is not terminated by one of the two users, the connection is terminated automatically after a time defined in the PABX (around.

Enable / inhibit intercom call reception

				
Lift up handset	Enable intercom calls / Inhibit intercom calls		Ack. signal	Replace handset

Voicebox (Answering machine)

A Voicebox (answering machine) is required when there are several subscribers or teams within the PABX system. You can either let each subscriber or team have their own separate answering machine, or you can utilize the Voicebox system (central answering machine) integrated into the PABX. Up to 8 individual Voiceboxes can be configured (depending on the capacity of the Compact Flash Card used). A Voicebox in the PABX system is assigned to the internal number for a subscriber or team (team number) for individual use by that subscriber or team for this purpose. When Voiceboxes are activated calls for the subscriber or for the team are accepted automatically after a set time. The caller then hears an announcement and can, depending on the set mode, leave a message.

You must use a Compact Flash Card in the PABX system in order to utilize the integrated Voicebox system.

Subscribers that have been assigned a Voicebox and configured using the Configurator can also edit calls by entering the appropriate code.

Note

You cannot set up a voicebox for SIP-phones!

Note

The following Voicebox operations can be easily and conveniently performed using the elmeg CS400xt and elmeg CS410 system telephones. These system telephones have a special menu for use with softkeys. If you already have one of these system telephones you can load new telephone software (Firmware) Version 4.0, as described in the Operating Manual for the phone.

Note

The Voicebox can not be used for inquiry calls. TAPI subscribers can only use their own Voicebox and not ones from other subscribers.

Note

If the Voicebox is used via the POTS module the recording time for each call is limited in accordance with the corresponding entry in the Configurator. If the maximum time period is set, the recording time will be limited to 30 seconds. With the »Busy tone detection« feature configured for the POTS-module, you can use the maximum recording time.

Voicebox system performance features

- Use of the Voicebox is PIN-protected
- Up to 8 individual Voiceboxes (depending on capacity of Compact Flash Card being used)
- Central sign-off text for all Voiceboxes
- 2 modes: »Voicebox« with recording, or »Announcement only« (Infobox)
- Time up to accepting of call can be configured
- Notification at the phones or system phones of new messages
- Use / Remote control of a Voicebox protected by means of an individual 4-place PIN
- Configuring the Voiceboxes through configuration, or via the system telephone

- Logging of calls

Connections to the Voicebox system

- Only one connection is possible at a time to the Voicebox.
- Up to two simultaneous connections can be made to the PABX Voicebox system.
- Connections to the Voicebox system include listening to announcements, messages or recordings, leaving messages.
- Recording of calls, or remote control of a Voicebox.
- If the maximum number of connections to a Voicebox, or to the Voicebox system has been reached, further attempts will be refused, either with a negative acknowledgement signal or a busy signal.
- If a call for a subscriber or a team cannot be transferred to a Voicebox for this reason, the call will continue to be signaled at the corresponding subscriber(s).

Number of Voiceboxes and free recording time for each Voicebox

The number of available Voiceboxes and the recording time available depend on the capacity of the Compact Flash Card used in the system. The maximum number of Voiceboxes is defined in the table below, based on the capacity of the Compact Flash Card. This number is specified in the PC configuration, but only when configured Voiceboxes are active.

Note

If you have configured fewer Voiceboxes than the maximum number, the available storage (recording) capacity is distributed among these Voiceboxes. Around half of the total storage space is reserved for WAV files (melodies) that are stored on the CF Card (with 16 MB ~ 8MB, with 512 MB ~ 256 MB). If the available storage capacity for the Voicebox is exhausted, the caller will hear a busy signal at the beginning of the announcement. Further recording and a sign-off announcement are not possible.

The following illustration in the configuration for «Voicebox» shows examples of the number of available Voiceboxes for a 64 MB (top) and a 1GB (bottom) Compact Flash Card. The screen mask for the Configurator shows the number of Voiceboxes that can be set up for a particular configuration. Only subscriber 20 is given in the example shown here; this subscriber can use the maximum recording time in this case. The table below shows the potential recording time and number of possible Voiceboxes as a function of the capacity of the Compact Flash Card.

No.	Subscriber	Display for	Remote p...	Calendar	Day mode	Switch on	Night mode	Switch on	Active
00	23	23	Yes	no cal.	Speak	immediate	Speak	immediate	Yes
01	25	25	Yes	no cal.	Speak	immediate	Speak	after 5 seconds	Yes

No.	Subscriber	Display for	Remote p...	Calendar	Day mode	Switch on	Night mode	Switch on	Active
00	23	23	Yes	no cal.	Speak	immediate	Speak	immediate	Yes
01	25	25	Yes	no cal.	Speak	immediate	Speak	after 5 seconds	Yes
02	17	17	Yes	Cal. 1	Speak	immediate		not active	Yes
03			No	no cal.		not active		not active	No
04			No	no cal.		not active		not active	No
05			No	no cal.		not active		not active	No
06			No	no cal.		not active		not active	No
07			No	no cal.		not active		not active	No

Number of Voiceboxes and free recording time for each Voicebox

Storage capacity	Number of Voiceboxes	Recording time per Voicebox in minutes
8 MB	none	—
16 MB	1	8
32 MB	1	16
32 MB	2	8
64 MB	1	32
64 MB	2	16
64 MB	3	10,7
64 MB	4	8
128 MB	1	64
128 MB	2	32
128 MB	3	21,3
128 MB	4	16
128 MB	5	12,8
128 MB	6	10,7
128 MB	7	9,1
128 MB	8	8
256 MB	1	64
256 MB	2	64
256 MB	3	42,7
256 MB	4	32

Number of Voiceboxes and free recording time for each Voicebox		
256 MB	5	26,5
256 MB	6	21,3
256 MB	7	18,3
256 MB	8	16
512 MB	1	64
512 MB	2	64
512 MB	3	64
512 MB	4	64
512 MB	5	51,2
512 MB	6	42,7
512 MB	7	36,6
512 MB	8	32
1 /2 GB	1	64
1 /2 GB	2	64
1 /2 GB	3	64
1 /2 GB	4	64
1 /2 GB	5	64
1 /2 GB	6	64
1 /2 GB	7	64
1 /2 GB	8	64

If you change the Compact Flash Card while the system is in operation the number of Voiceboxes will be adapted to the capacity of the new card. For example, if you have configured the Voicebox system for a 128 MB card and then install a 64 MB card, the Voiceboxes that were configured last will be de-activated automatically. If you then install a 128 MB card again at a later time, the de-activated Voiceboxes will then be re-activated.

Note

Up to 99 messages can be stored in each Voicebox (depending on the capacity of the Compact Flash Card being used). Messages that are shorter than 2 seconds are not recorded. For example: A caller ends the call after the request signal without actually leaving a message.

The Voicebox will be de-activated automatically if its recording time has been exhausted. The Voicebox can be re-activated after messages have been listened to and deleted.

Note

Compact Flash Cards with Microdrive are not supported.

Settings for a Voicebox

Announcements and operating modes

An announcement text (greeting message) and information texts can be stored. These announcements are spoken over the phone. In the mode »Record« a caller will hear the announcement text and can then leave a message after the signal. The caller will hear the information text in the mode »Announcement only«. In this mode it is not possible to leave a message.

As with the call modes for teams, a distinction is also made between a Day and Night mode for Voiceboxes. You can define different settings (mode, time until call is accepted) for both modes. Switchover between the modes »Day« and »Night« is made by entering a code on the phone, or is carried out automatically by a calendar function in the PABX system.

In the default settings for the PABX system a greeting and sign-off text have already been stored in the PABX memory. These texts can not be changed through configuration. The sign-off announcement is always used for all Voiceboxes when there is less than 10 seconds recording time available for a Voicebox. When the maximum recording time is set, the busy signal is heard at the end of this period, and not a sign-off message.

Note

Own welcome texts or sign-off messages you record will overwrite the default recordings. When you delete your own texts the system will automatically reload the factory default texts.

Operation

A Voicebox can be operated from any internal or external telephone. Operation is safeguarded by an individual 4-place PIN (initial (default) setting »0000«). Recording of announcements, listening to messages or changing settings can only be carried out after entering this PIN. To operate a Voicebox from an external telephone (remote location), the remote operation function for the Voicebox must first be enabled in the configuration.

Configuration

Voiceboxes are configured in the PC configuration program. You can make all necessary settings for Voiceboxes with this program. By entering the appropriate codes at a telephone you can set the mode (Day / Night), record announcements/information texts, or listen to messages.

Using the Voicebox at a phone



Using the Voicebox at an internal phone



You can use the Voicebox either from an assigned, internal phone, or from any arbitrary internal phone. Once you have set up the connection to the Voicebox you can listen to messages, conduct configuration or record announcements / information texts. Use of all Voiceboxes is protected by individual PINs. Should you forget your PIN you can reprogram it through PC configuration.

Activating / De-activating a Voicebox from an assigned telephone





You can activate or de-activate a Voicebox from an assigned telephone. A team Voicebox can be activated by any team member using the team number. When a Voicebox is activated the system automatically checks whether an announcement or information text has been saved for the selected mode and whether more than 10 seconds recording time is available for that Voicebox. An active Voicebox is de-activated automatically if there is less than 10 seconds free recording time available for that Voicebox.

Activating a subscriber Voicebox

-  Lift up the handset of your phone. You will hear the internal dial tone.
-  Press the asterisk key (*) to activate the unit.
-  Press the hash key for deactivating.

- 3 0 #** Dial this code. Confirm your entries by pressing the hash key.
-  You will hear the positive acknowledgement signal.
-  Replace the handset.

Activating a team Voicebox

-  Lift up the handset of your phone. You will hear the internal dial tone.
- *** Press the asterisk key (*) to activate the unit.
- #** Press the hash key for deactivating.
- 3 0 *** Dial this code.
-  Enter the team number.
- #** Confirm your entries by pressing the hash key.
-  You will hear the positive acknowledgement signal.
-  Replace the handset.

Logging of calls



An internal subscriber that has been allocated a Voicebox may record calls. The Voicebox does not have to be activated to record a call. Recording can not be performed if the recording time for a Voicebox is exhausted. In this case the call is briefly disconnected and you will hear the negative acknowledgement signal. A team Voicebox can not be used for recording.

Before recording a call let your calling partner know that you are activating the recording function so that he/she can consent.



After you enter the code for recording a call the call will be recorded until:

- The code for ending of recording is entered.
- The call is ended by hanging up the handset.
- There is no longer any recording time available on the Voicebox.

Recording calls at an ISDN phone

-  You are conducting a call and would like to record it.
-  Switch the phone to Keypad.
- * 3 3** Enter this code to begin recording.
The call will then be recorded.
- # 3 3** Enter this code to end current recording.
-  Continue with your call.

Recording a call at an analog phone

-  You are conducting a call and would like to record it.
- R** Press the R key. You will hear the internal dial tone. The caller is on hold.
- * 3 3** Dial this code.
-  Continue with your call. The call will now be recorded.
- R** Press the R key. You will hear the internal dial tone. The caller is on hold.
- # 3 3** Enter this code to end current recording.

 Continue with your call.

Note

Recording is terminated automatically when you hang up the handset while recording a call.

Using a Voicebox at an assigned phone

Notification of new message in Voicebox

When new messages are present on the Voicebox:

When the internal party hears the special dial tone for teams instead of the internal dial tone, you can specify in the configurator, whether this tone is to be heard by just one team member or by the entire team.

On analog devices, the subscriber hears a short signal tone, when a new message has been received. When the call waiting tone has been enabled on system telephones the message will be signaled using this tone.

The »MWI« LED - if fitted - lights up. This setup is carried out in the configuration.

A special text or symbol will be shown on the display of the phone (e.g. *39#).

To receive these tones and displays »Voicebox MWI« must have been set up for that particular extension.

The team member that is notified when there is a new message in the Voicebox must be defined in the Voicebox configuration for a team Voicebox.

Listening to messages / recording calls

The oldest message is always played back first. All of the messages are then played back from oldest to newest. If no newer messages are present you will hear the negative acknowledgement signal. A new message counts as having been played back even if you only listened to part of the message.

Procedure for entering the Voicebox menu

You only need to enter the following procedure *39#** one time; after that you can utilize all the procedures described in the following one after the other. After entering this procedure wait around 3 seconds before entering any other codes. You can always press the number key (#) and enter the following code to return to the beginning of the menu.**



Lift up the handset of your internal phone.



Select the procedure for the Voicebox.



You will hear the positive acknowledgement signal.



Enter the PIN for the Voicebox (default setting 0000).



Confirm your entries by pressing the hash key.



You will hear the positive acknowledgement signal.

After entering this procedure wait around 3 seconds before entering any other codes. The Voicebox codes are given under »Quick reference guide for Voicebox « (Page73).

Note

You will be returned to the main menu immediately when you press the number key (#) while a function is being executed, for example »Listen to new messages«. If, in the example shown here, you have finished listening to a new

message and then press the number key (#) you will hear the negative acknowledgement signal even though you are still located in the main menu.

Listening to new messages or to recorded calls

- 1** Dial this code. The new messages are then played back one after the other, with each one being separated by the positive acknowledgement signal.
If no new messages are present you will hear the negative acknowledgement signal and are returned automatically to the beginning of the input procedure again, as if you had pressed the number key (#).
Then, select the function while the message is being played back:
 - 1** Listening to the next message (end the message you have just listened to and listen to the next one in the sequence).
 - 2** Repeat the message just listened to (the message that you have just listened to is repeated).
 - 3** Delete the message just listened to (the message that you have just listened to is deleted).

Listen to old messages or recorded calls

- 2** Dial this code. Older messages are played back one after the other, each one separated by a positive acknowledgement signal.
If no older messages are present you will hear the negative acknowledgement signal and are returned automatically to the beginning of the input procedure again, as if you had pressed the number key (#).
Then, select the function while the message is being played back:
 - 1** Listen to next message.
 - 2** Repeat message just listened to.
 - 3** Deleting of the last message that was listened to

Delete all saved messages and recorded calls (new ones and ones that have already been played back)

- 3** Dial this code. You will hear the positive acknowledgement signal.
 - *** Press the asterisk key; all messages that have been listened to previously will be deleted.
-  You will hear the positive acknowledgement signal.

Activating/De-activating the Voicebox

- 4** Dial this code.
Then select the desired function:
 - 0*** Activating the Voicebox in the current mode.
 - 00** Deactivate Voicebox.
-  You will hear the positive acknowledgement signal.

Activating the Voicebox in the »Day« or »Night« call mode

- 4** Dial this code.
Then select the desired function:

0 1 Activating the Voicebox in the »Day« call mode.

0 2 Activating the Voicebox in the »Night« call mode.

 You will hear the positive acknowledgement signal.

Configuring the »Day« call mode.

4 Dial this code.

Then select the desired function:

1 0 Deactivate Voicebox.

1 1 Activate the Voicebox, calls taken immediately.

1 2 Activate the Voicebox, calls taken after set time (delayed)

1 3 Activate voicebox on busy

1 4 Activate voicebox on busy an by time (delayed).

1 5 Activate the Voicebox as an answering machine. The caller hears the recorded announcement and can then leave a message.

1 7 Activate the Voicebox for announcement only. The caller hears the recorded announcement and can then leave a message.

 You will hear the positive acknowledgement signal.

Configuring the »Night« call mode.

4 Dial this code.

Then select the desired function:

2 0 Deactivate Voicebox.

2 1 Activate the Voicebox, calls taken immediately.

2 2 Activate the Voicebox, calls taken after set time (delayed)

2 3 Activate voicebox on busy

2 4 Activate voicebox on busy an by time (delayed).

2 5 Activate the Voicebox as an answering machine.. The caller hears the recorded announcement and can then leave a message

2 7 Activate the Voicebox for only one announcement. The caller hears the recorded announcement and can then leave a message.

 You will hear the positive acknowledgement signal.

Listening to or recording announcements

5 Dial this code.

Then select the desired function:

1 Listening to saved announcement texts.

2 Recording an announcement.

 You will hear the positive acknowledgement signal.







0 Dial »0« to end recording.

5 0 Dial »50« to accept the announcement text.

Listening to or recording information texts

- 5** Dial this code.
- Then select the desired function:
 - 4** Listening to saved information texts.
 - 5** Recording an information text.
 -  You will hear the positive acknowledgement signal.
 - 0** Dial »0« to end recording.
 - 5 0** Dial »50« to accept the information text.







Changing the Voicebox PIN

- 9** Dial this code.
- Then select the desired function:
 - 1** Changing the Voicebox PIN.
 -  Enter the new PIN (4 characters).
 -  Confirm your entry by pressing the asterisk key.
 -  Enter the new PIN (4 character) again.
 -  Confirm your entry by pressing the hash key (#).
 -  You will hear the positive acknowledgement signal.
 -  Replace the handset.

Note

The Voicebox codes are given under »Quick reference guide for Voicebox « (Page73).









Use from any internal telephone

-  Lift up the handset of your phone. You will hear the internal dial tone.
- * 3 9 *** Dial this code.
-  Enter the number for the Voicebox (number for internal subscriber or team number).
- #** Confirm your entries by pressing the hash key.
-  You will hear the positive acknowledgement signal.
-  Enter the PIN for the Voicebox.
- #** Confirm your entries by pressing the hash key.
-  You will hear the positive acknowledgement signal.
-  The Voicebox codes are given under »Quick reference guide for Voicebox « (Page73).

Remote control of Voicebox from an external phone













To use a Voicebox from a remote location remote polling must be enabled in the configuration and the 4/place PIN for the Voicebox changed individually (from default setting).

Remote control by dialing up the Voicebox

-  Lift up the handset of your phone (external subscriber).
-  Dial the number that is assigned to the internal subscriber or team. Wait until the Voicebox has taken the call.
Set your phone to frequency (DTMF) dialing, or use a DTMF manual transmitter.
-  *** 3 9 #** Dial this code.
-  You will hear the positive acknowledgement signal.
-  Enter the PIN for the Voicebox.
-  Confirm your entries by pressing the hash key.
-  You will hear the positive acknowledgement signal.
-  The Voicebox codes are given under »Quick reference guide for Voicebox « (Page73).

Remote control using remote polling function for PABX system

If remote polling has not been enabled via PC configuration »General«, the function must be enabled using »Enable / Inhibit remote access« via an internal telephone. You can then activate and use Voiceboxes from remote locations.

-  Lift up the handset of your phone (external subscriber).
-  Dial the number that is assigned to the internal Service number for the PABX system (point-to-multi-point access: MSN / Point-to-point connection: pabx number+direct dial-in).
If remote access has been enabled you will hear the special dial tone of your PABX.
Set your phone to frequency (DTMF) dialing, or use a DTMF manual transmitter.
-  Enter the 6-digit password (PIN2) for your PABX.
-  You will hear the acknowledgement signal for approximately one second.
-  *** 3 9 *** Dial this code.
-  Enter the number for the Voicebox (number for internal subscriber or team number).
-  Confirm your entries by pressing the hash key.
-  You will hear the positive acknowledgement signal.
-  Enter the PIN for the Voicebox.
-  Confirm your entries by pressing the hash key.
-  You will hear the positive acknowledgement signal.
-  The Voicebox codes are given under »Quick reference guide for Voicebox « (Page73).

Configuring the Voicebox using a system phone

If you have an elmeg CS410 or elmeg CS400xt system telephone connected to your PABX system you can configure and use a Voicebox in these systems using a special menu available in the system telephones.

This special menu for using the Voicebox is provided in the elmeg CS410 system telephone. The number / team number for the Voicebox must be stored in the telephone to use this function. When the phone is idle the softkey »Voicebox« is displayed. When this softkey and the call LED flash, this indicates that new messages have arrived at the assigned Voicebox. You can open the PABX system Voicebox menu by pressing this softkey. In this menu you can listen to messages or make further input / set the configuration for the Voicebox.

This menu, along with the functions it contains for using and configuring the Voicebox, is managed in the PABX system.

Note

The special menu for convenient use can only be used for one Voicebox at a telephone. You must install an optional Compact Flash Card in the PABX system to use the integrated Voicebox system.

Note

First, you must assign and configure a Voicebox for an internal subscriber under »Voicebox« in the configuration. Only then can you utilize the following setup procedure.

Configuring a number for the Voicebox in the system telephone

The number of your Voicebox must be stored in the system telephone. You can input this number using the PC configuration program for the system telephone, or using the system telephone as described below.

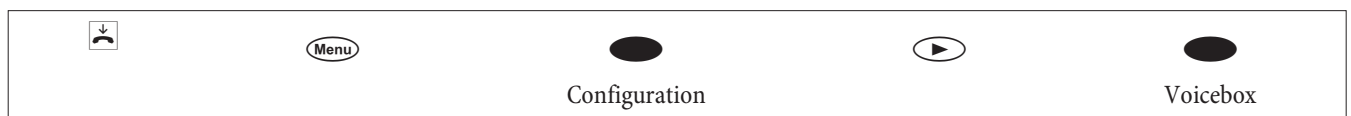
Begin as follows:

Enter the number for the Voicebox and confirm with OK (in the example shown here: 21).

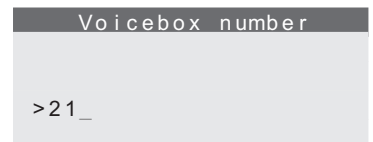
**Entering the Voicebox menu**

After you have stored the number for your Voicebox in the system telephone the softkey »Voicebox« is then added to and shown in the display when the phone is idle. When new messages are present in the Voicebox the Voicebox softkey begins flashing, along with the call LED of the system telephone. In addition, the number of new messages is also shown in parentheses behind the »Voicebox« softkey.

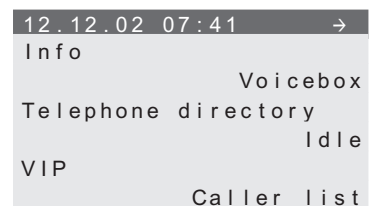

The telephone is idle. Press the »Voicebox« softkey.

**Note**

The Voicebox is activated when a checkmark »~« (as shown in the top display) is displayed behind the word »Voicebox«.



If the PIN is still set to the default setting (0000) the Voicebox menu can be opened by pressing the

»Voicebox« softkey. If the PIN has been changed you will first be asked to enter the PIN

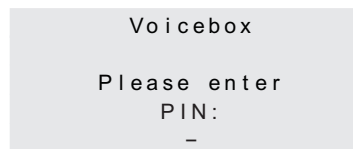

- The menu that is displayed is controlled by the PABX system and can be used for operating and configuring the Voicebox whose number has been stored in the telephone.

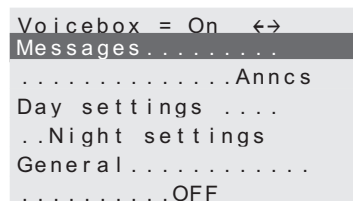

To open one of the menus displayed,

- press the corresponding softkey next to the desired menu.

or

- Use the arrow keys to select the desired menu and confirm your selection with OK

Recording announcements

You can record two different announcements (announcement text and information text) for each Voicebox. The length of the two announcements is subtracted from the available recording time for that Voicebox. In brief this means that the longer the two announcement texts, the less free storage space that is available for leaving messages.

Begin as follows:

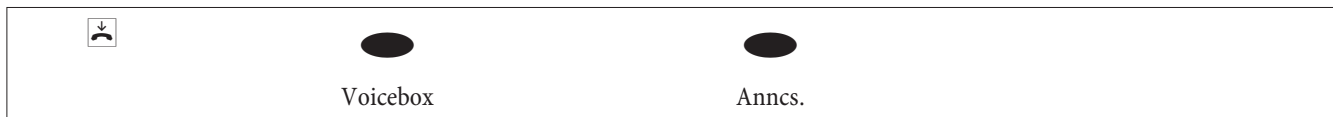

- Select the desired menu item. Depending on the menu item, further selections / settings or input can be made.

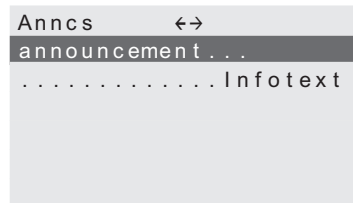

»Announcement text«

A caller hears the announcement text in the »Record« mode.

»Infotext«

A caller hears the information text in the »Announcement only« mode.

In this menu you can listen to or delete an existing announcement/information text, or record a new text. A newly recorded announcement/information text is stored in the PABX system only after you press the softkey »accept«.

Settings for the »Day« and »Night« modes

As with the call modes for teams, a distinction is also made between a Day and Night mode for Voiceboxes. You can define different settings for both of these modes.

You can also change the active mode in this menu (»Day« to »Night« and vice versa). You can recognize the active mode here (Day/Night) by the fact that the other (inactive) mode will be offered for you to select for changing. In the example shown here the »Night« mode is active. You can select this menu item to switch to the »Day« mode.

Begin as follows:



Select the desired menu item. Depending on the menu item, further selections / settings or input can be made.

```
Settings Day ↔
Status after: 30
...Mode: Speak
Activate Night.....
```

»Status.....

Here, you define the time period during which the Voicebox is to take calls in the selected mode (»Day« or »Night«).

»OFF«

The display shows: »Status: off« The voicebox is not active.

»per time«

The display shows: »Status after 15 seconds«. Time options available »5, 10, 15, 20, 25 s, 30 s«.

»Time + Busy«

The display shows: »Status 15 seconds + Busy«. The available options are »Busy« and Time »5, 10, 15, 20, 25 sec, 30 sec«.

»on busy«

The display shows: »Status on busy«. Activate when user is busy.

»immediately«

The display shows: »Status immediately«. The call is transferred to the voicebox right away.

»Mode: «

You can choose between two different operating modes for each call mode (»Day« or »Night«) for using the Voicebox.

»Speak«

The display shows: »Mode: Speak«: In this operating mode the caller will hear the announcement text and can then leave a message after the signal.

»announcement only«

The display shows: »Mode: Voice announcement only«: In this operating mode the caller will hear the information text. In this mode it is not possible to leave a message.

»Activate Night«

You can select this menu item to switch the Voicebox over to the other (inactive) mode.

»Activate Day«

General settings

The general settings apply to the Day and Night modes for the Voicebox.

Begin as follows:



Select the desired menu item. Depending on the menu item, further selections / settings or input can be made.

```
General ↔
Msg. length:30 sec...
.....Message 21
Access-PIN.....
.....Remote polling:
Ok
```

»Msg. length: «

Define the time available to a caller for leaving a message. For example: »30 sec.«, »60 sec.«, »90 sec.«, »120 sec.« or »max«.

»Message 10«

Here, you define which internal subscriber (ext. 10 in this example) is to be informed when new messages are present on the Voicebox. Notification of a new message is made by playing a special dial tone at the corresponding subscriber. Notification on system telephones configured with access to a Voicebox is in the form of a flashing call LED and flashing softkey »Voicebox«.

»Access-PIN«

Here, you can change the PIN for your Voicebox. The Voicebox is protected against unauthorized access by a PIN. The PIN must be input from a telephone during operation / remote control of the Voicebox.

»Remote polling«

You can define whether your Voicebox can be used from a remote location. Using remote access you can listen to messages from a remote location, or make configuration settings for the Voicebox (for example, activating/de-activating the Voicebox).

Listen to messages

The oldest messages or recorded calls are always played back first. The date and time and number of the caller (if available) are displayed for each message. Recorded messages can be deleted while they are being played back.

Begin as follows:

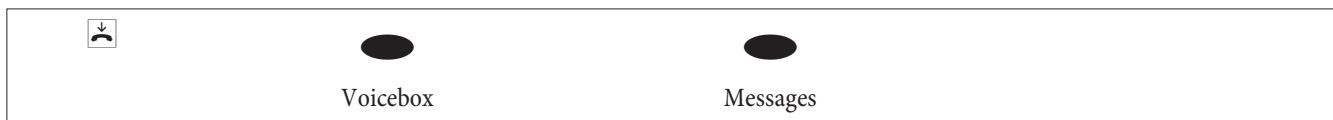

Select the desired menu item. Depending on the menu item, further selections / settings or input can be made.

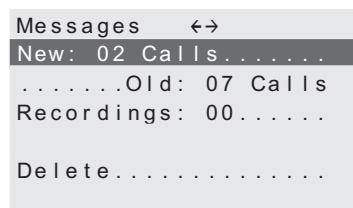

»New: Calls«

The new messages are then played back one after the other. All messages are played back one after the other. A new message counts as having been played back even if you only listened to part of the message. Messages that have been listened to are placed automatically in the list of older messages.

»Old: Calls«

Messages that have been listened to are played back one after the other. All messages are played back one after the other.

»Recordings:«

Recorded calls are played back one after the other. All stored, recorded calls are played back one after the other.

»Delete«

You can use this to delete all the messages in the Voicebox that have been listened to. Deleting of messages may require several seconds, depending on the storage time used by the messages (quantity and length of the stored messages).

Note
It is meaningful to regularly delete messages that have already been listened to in order to make room for new messages.

Commissioning the phone part

Phone number plan

When you start up your PABX for the first time a number of settings are already pre-configured (default settings). This includes the internal numbers. This means that you can place calls immediately after switching on your PABX.

Internal numbers:

- Numbers 20...29 are set for the »Connection of ISDN terminal devices« on the internal ISDN bus.
- The internal numbers 10...17 are provided for analog ports, numbers 30...39 for CAPI and numbers 40...43 for the DSL-router.
- Internal service number: The internal number 55 has been assigned as the service number. This number is used to provide access for the PC to the PABX system via the internal ISDN connection. You can configure the PABX via the internal ISDN connection and a PC with an ISDN card.
- External service number: An MSN or, with a point-to-point access, a direct dial-in number is assigned to the internal service number 55 during PC configuration. This »external service number« is the only access possible for configuring »Follow me« and »Room monitoring« from an outside location.
- Team 00: In the initial state the numbers 10, 11 and 20 are entered and enabled for Team 00 in the day/night team call allocation.

Default setting

- The external ISDN connection is set to point-to-point access.
- The four-digit PIN1 (password) is set to **0000**.
- The six-digit PIN2 (password) is set to **000000**.
- Assignment of an external ISDN connection is made by entering **0**.
- The internal ISDN bus is configured as »internal S0 bus«.
- The switchable call mode for Team 00 is set to »Day mode«.
- The group call is set for »simultaneous«.
- The switching privilege for teams is configured for no terminal device.
- All users are in Pick-up group 00.
- Accepting (pick-up) of a call is possible for all terminal devices.
- All subscribers can use the telephone directory.
- No terminal device is authorized for SMS reception.
- The analog connections are configured for telephones that use DTMF dialing and a flash key (200 ms).
- The active terminal devices are authorized for international calls.
- The dial range is not configured.
- The number of the caller is displayed (caller ID).
- The B number is transmitted to the caller.

- Call waiting for a/b terminal devices has not been configured.
- No entries in telephone directory.
- Music on hold (MOH): Melody 1 is played.
- No time or date is stored.
- The charge rate counters are set to 0.
- No connection data records are stored.
- The numbers in the call data records are shown in full length.
- Call data records for incoming calls are stored only when a project number has been assigned.
- Analog charge rate transmission is deactivated.
- Analog number transmission is activated.
- The keypad function for the external ISDN connection is not enabled for terminal devices.
- The meter pulse frequency is set to 16 kHz.
- Remote access can be initiated from any terminal device.
- Remote switching authorization (External follow me) is deactivated.
- The switchover times are set as follows in the calendar for all days of the week:
Switching Night / Day: 8:00 AM,
Switching Day / Night: 4:00 PM
- A calendar has not been assigned to the team options.
- LCR is not active.
- Call charge logging is de-activated for all subscribers.
- Initial setting for the router, please refer to page 60.

Initial startup (telephone operation)

Install your PABX as described in the installation instructions. These can be found on the CD under »Installation instructions«.

Make all necessary connections, including the 230 V AC mains power supply.

In its initial state, the PABX will signal an external call at the analog terminal devices and at the ISDN terminal device that has the number 20.

The MSNs (for example the numbers for the subscribers in Team 00) must be entered in the terminal devices to ensure that the other telephones and terminal devices you have connected to the system can continue to all be reached by external parties.

If your PABX system is set for use at a point-to-point connection it is crucial that you enter your local area code in the Section »Dialing region« in PC Configuration. Only after doing this can you take advantage of features such as »Call forwarding« (Partial Rerouting) and »Automatic Call-back«.

The internal numbers (or MSN extensions) have default settings in the PABX's initial state. You can change these internal numbers as you require through configuration with the PC. Consult the operating instructions for your ISDN terminal devices to find out how and with which settings the various features can be used.

Note

Your PABX supports the flash function for analog telephones. Therefore, never just briefly replace the handset or press the button in the cradle briefly with your hand, as the PABX would take this as a flash signal instead of hanging up.

Configuring performance features using a telephone

Various settings are protected by PIN1 in the PABX. In the default state, this PIN 1 is set to 0000. Write down your PIN 1 and keep it in a safe place, because if you forget or lose your PIN 1 you will no longer have access for configuring the PABX over a telephone.





»Remote access / remote control« is protected by PIN 2.

Remote access using this 6-digit PIN2 is only possible when this PIN2 has been changed individually, i. e. it is no longer in its initial setting of 000000.

Service access

This feature enables you to have the PABX configured by your dealer's service center or download the current software of the PABX. You can trigger this function from an internal phone of your PABX or release your PABX for access by an external PC (for example your specialized dealer).

Outgoing service call (solution with 2 B-channels)

-  You call the service center. You are connected with the service technician who then explains the further procedure to you.
- R** When requested by the technician you push the Recall flash button You will hear the internal dial tone.
- * 7 9 2** Dial this code .
If you wish to establish a service connection with the services maintenance and diagnosis, enter the code number *** 7 9 4**.
-  Dial the number of the service center.
- #** Finish input.
-  You will hear the positive acknowledgement signal.
-  You are then re-connected with the service technician and can continue your call.

Outgoing service call (access via 1 B channel)

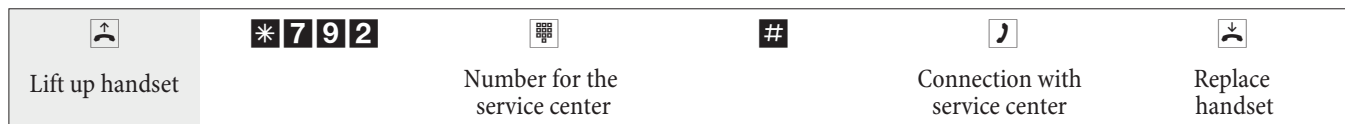

You will hear the internal music on hold once a connection to the service center has been established. When the data have been transferred the service center will terminate the connection. You hear the busy signal.

Ending an active, incoming service link

You can terminate a connection set up by the service center using the following procedure.

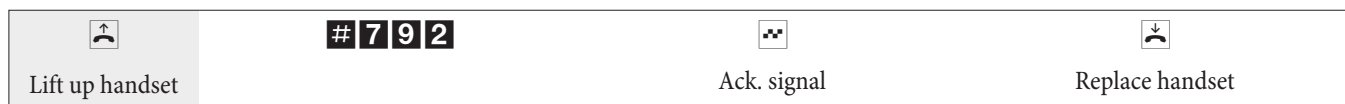

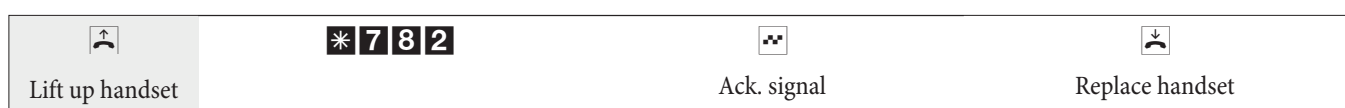

Enabling for remote service access

You can release your PABX system for remote access by an external subscriber. Release for remote access of the PABX is effected for 30 minutes.





Enabling for remote service access (no checking of subaddress)

You can release your PABX system for remote access by an external subscriber. Release for remote access of the PABX is effected for 30 minutes.

 Lift up handset	# 7 8 2	 Ack. signal	 Replace handset
--	----------------	--	--

Deleting authorization for remote service access

You can cancel a programmed release for incoming remote access any time you want. However, an existing connection to a service center is not terminated.

 Lift up handset	# 7 9 9	 Ack. signal	 Replace handset
--	----------------	--	--

Setting features using a telephone

After you begin configuration you can set the features for your system using the codes described here. The telephone being used for programming can not be reached while the system is being configured.

You will hear the positive acknowledgement signal once you successfully conclude configuration for a setting. You can then move on to configure the next setting. If you wait for more than 40 seconds between one entry and another, the PABX will terminate configuration and you will hear the busy signal. All input made up to that point which was concluded with a positive acknowledgement signal will be saved when you hang up the handset. Saving is performed for 10 seconds after you hang up the handset. During this period it is important that you do not begin a new configuration of the system, and that power is not interrupted to the system.

You must perform the following procedure at the beginning of each subsequent configuration process.

 Lift up handset	* *	 Ack. signal	0 0 0 0 Enter PIN 1	 Ack. signal
--	------------	--	-------------------------------	--

Changing PIN 1 or PIN 2

You can prevent misuse of your PABX by other parties by implementing various security functions. Your PABX settings can be protected using your 4-digit PIN1 (code number). Access by external parties (remote access) is protected using your 6-digit PIN2.

PIN 1 (4-digit): Security precaution against misuse of your PABX by other parties.

PIN1 is a 4-digit code number that is required when you wish to protect your system settings against unauthorized access.

PIN 2 (6-digit): Security for settings made from external telephones



For the settings:

- Call forwarding (Follow me) from external location
- Room monitoring from external location

prevent unauthorized parties from using your PABX. Only after you enter this 6-digit PIN2 are you allowed to utilize functions in your PABX that can be activated/deactivated from external telephones.

Note

Remote access using this 6-digit PIN2 is only possible when this PIN2 has been changed individually, i. e. it is no longer in its initial setting of 000000.

9 1 1	or	9 1 2			
Change PIN 1 (4-place)		Change PIN 2 (6-place)	Enter new PIN	Enter new PIN (confirm)	Ack. signal

Activating Least Cost Routing (LCR)

7 8 1	2 / #	
Code	Enabling / Inhibiting LCR	Ack. signal

Remote access / remote control: enable / inhibit

7 8 0	* / #	
Code	enable / inhibit	Ack. signal



Setting the date and the time

9 8	0 1 ... 3 1	0 1 ... 1 2	0 0 ... 9 9	0 0 ... 2 3	0 0 ... 5 9	
Code	Day	Month	Year	Hours	Minute	Ack. signal

Deleting the charge counter for one internal subscriber or for all

8 5 0	 or *
Code	internal number or * for all internal extensions

Setting up call accounts

8 3 0			#	
Code	Int. extension number	amount (max. 6-place, with a factor of 1000)		Ack. signal

Deleting call accounts

8 3 0		#	
Code	Int. extension number		Ack. signal



Activating / deactivating an extension's call account

8 9 0		* / #	
Code	Int. extension number	Activate / Deactivate	Ack. signal

Resetting settings to default state (Reset)

9 9 9
Code

Resetting one internal extension or all

900	 or 	
Code	internal number or * for all internal extensions	Ack. signal

Commissioning an IP-phone for a DSP module

When your PABX is equipped with an optional DSP module. After your PABX system has run up it will recognize the module and you can then begin configuration at the IP phone.

Note

This short description is based on the DHCP set up in the PABX.

The elmeg IP290 is used as an example in this description.

Note

An instruction manual describing all currently available features can be found on the CD-ROM.

Initial startup

Connect the pabx to the IP telephone using the network cable. Connect the plug-in power supply unit and the telephone and switch the power on.

Language setting

```
Select Language:
← English →
```

Use the arrow keys   to select the language . Press O to confirm.

```
Select Language:
← Deutsch →
```

Selecting a calling tone

Use the arrow keys   to select the country. Press  to confirm.

```
Dial tone:
← Australia →
```

```
Dial tone:
← Deutschland →
```

Select a time zone

Select a time zone using the arrow keys   . Press O to confirm.

```
Dial time zone:
← -10 USA (Honolulu) →
```

```
Dial time zone:
←+1:Deutschland(Berlin) →
```

First log-in

A user must have been set up in the pabx. Enter your user ID (for example for MSN22) which consists of the MSN extension, followed by an “@” and the IP_ address for the PABX.

```
ID:
22@192.168.1.250
```

Enter an ID for the MSN22 and the IP address 192.168.1.250:

After entering your user ID confirm it by pressing the O key.



12/30 (22) 10:22 AM
Idle Telbook
Lists

You will be asked to input the log-on PIN, if this security feature has been set up for your PABX.

After you have logged on successfully you will see the new number (22) in the display.

PABX and PC

A CD containing the Windows configuration program and other software and drivers is included in the PABX package.

Note

The first time you start the Configurator you will be asked to enter your user ID and password. Use »Service« as your user ID and also »Service« as the password. Please note that these words are case-sensitive! Once you've been logged on to the Configurator you can change your user ID and password as you like.

Contents of the CD-ROM

In these operating instructions we would like to give you a brief summary of the software included in the scope of supply for the system. The software programs themselves are not described in these instructions. Should any questions or problems arise while you are using the programs you can use the online Help function for assistance. All programs are equipped with a comprehensive online Help function.

Programs for configuring the PABX

Professional Configurator:

The settings for the individual features of your PABX are made in the PABX configuration. You can configure your external MSN and assign these numbers to individual, internal users, or to a team consisting of several users (members). You can also assign a name for each individual, internal user and configure the various features separately (such as authorization privileges, exchange line access, cost logging, etc.), or you can apply the settings of one user to those for a different user. Configuration is also used to define the calendar, numbers for call control (unrestricted numbers, restricted numbers) and emergency or direct calls. You can also make general settings for the PABX, for call data logging or for remote access to the PABX system.

Charge Manager:

You can use the charge manager program for logging connection data for reading out or clearing call data records stored in the PABX and user-specific counters. The call data records that are read out can be evaluated using various sorting and filtering functions, or exported for processing in other programs.

For example: Sorting functions allow you to compile data records according to internal users, project numbers or numbers that are dialed/transferred. The filtering functions can be used to display data records containing individual properties. You can set these filtering functions to fit your specific needs.

Telephone Directory Manager:

The PABX system is equipped with an integrated telephone directory, in which you can store up to 500 numbers, with their associated names. You can access the PABX telephone directory with all phones connected with the system. System telephones can also use the PABX menu. Other telephones can use a code to dial from the telephone directory. Entries are added to the directory using the Telephone Directory Manager on the CD. The import/export function of the telephone directory manager allows imported or exported data to be edited and processed in other programs.

ControlCenter:

The Control Center monitors the activities of the router for establishing and severing a connection. It indicates for instance: the provider used for the current connection, the type of connection (ISDN or DSL), the IP address, the duration, the port, the up- or downloaded data volume. You can also terminate an ongoing connection or establish a new one.

Download Manager:

Using this program you can load new system software via your PC into the PABX. You can load new software via the integrated USB port, or via the Ethernet port »LAN« of your PABX system. If an ISDN card is already installed in your PC you can also update the system software via the internal ISDN connection of the PABX.

TAPI-Configurator:

Using TAPI Configuration you can adapt the TAPI driver for a program that uses that driver. You can also check which MSN is assigned to which terminal device, define new line names and can set the dialing parameters. First configure the PABX. Then, you must configure the TAPI interface. Use the program »TAPI Configuration« in the WINTool Launcher.

LCR Professional

Both provider and routing tables can be prepared and edited individually using this new LCR procedure. This LCR procedure can be configured using the Web-based PC program supplied with the system.

You can activate/de-activate the LCR procedure using either the »Professional Configurator«, or a code sequence on the telephone.

Application programs

Adobe Acrobat Reader:

Program for viewing and printing PDF documents.

Drivers

USB driver (Universal Serial Bus)

Recognition and control for the PABX system after being connected to the USB port of your PC. The USB driver is installed as a virtual network card that uses the TCP/IP protocol.

TAPI in the LAN:

The package includes a program called »TAPI for LANs« for use in your network. This software can be installed on any PC in the network. This gives you the possibility of running your TAPI application from a central location via an interface, i. e. the PABX system. There is no ISDN card required for the PCs. Please note that software used for the TAPI application may require certain license agreements with the software manufacturer. Up to 10 users, the program »TAPI in LAN« does not require a license to run.

CAPI in LAN:

The package includes a program called »CAPI for LANs« for use in your network. This software can be installed on any PC in the network. This gives you the possibility of running your CAPI application from a central location via an interface, i. e. the PABX system. There is no ISDN card required for the PCs. Please note that software used for the CAPI application may require certain license agreements with the software manufacturer. Up to 10 users, the program »CAPI in LAN« does not require a license to run.

Installation instruction for Windows 98

If you have Windows 98 installed on your PC you must observe the following installation instructions for the USB driver. Keep the original Microsoft Windows 98 CD handy.

Initial installation

Connect your PC to the USB port of the PABX system via the USB cable and switch on both devices. Insert the CD supplied with the system. The Windows 98 hardware assistant is then started.

Installing the driver:

- A »Composite USB device« is then recognized.
- Click »Next«
- Select »Search for the best driver for your device. (Recommended)« and then click »Next«
- Select »CD-ROM drive« and then click »Next«
- Select »Updated driver (recommended)«.
- Select »elmeg USB Remote NDIS Network Device« and click »Next«
- Click »Next« once again to install the USB driver.

- Press the »Finish« button

Note

When the installation has been performed correctly, the following entry will appear in the device manager under the list of network cards: »elmeg Txxx USB Remote NDIS Network Device«.

Removing the default driver

If you have not installed the elmeg USB driver, the standard driver for »Composite USB device« will be installed by Windows. This is indicated by an entry in the device manager under »Universal serial bus controller«. You must first remove this standard driver before you install the new elmeg USB driver as explained under »Installation«.

- Removing the driver:
- Open the »Device manager«
- Remove the entry »Composite device« under »Universal serial bus controller«.
- Remove the entry »elmeg« under »Other components«
- Then unplug the USB connector from the device and plug it in again. The device is recognized anew.
- Install the new driver

CAPI driver (Common ISDN Application Programming Interface):

Interfacing of the pabx to programs that provide data communication services.

Important for Installation of the CAPI driver

Note

The CAPI driver is not required for accessing the Internet.

Before installing the new drivers be sure to remove any existing CAPI drivers in your system (such as the drivers for an installed ISDN card), as Windows only supports one installed CAPI.

Refer to the operating instructions for the device concerned, or for the operating system, for details on removing drivers.

You can also use other programs that access the CAPI drivers for the PABX system. Refer to the operating instructions for the software packages concerned for detailed information.

Note

In some special circumstances it may be necessary to also physically remove the ISDN card from the PC in addition to removing the drivers.

TAPI driver (Telephony Application Programming Interface)

Interfacing to programs that provide computer-aided telephony.

For ex. Windows dialing assistant

Special drivers must be installed if you wish to use the configuration software via the USB port of your PABX.

Installing programs from the CD

System requirements:

- IBM or 100% compatible PC
- Pentium or comparable processor, min. 233 MHz clock rate
- min. 64 MB RAM
- VGA graphics adapter, approx. 65,000 colors, a resolution of at least 1024x768 pixels.
- CD ROM drive
- Free USB-port
- Windows 98 / ME / XP / 2000 operating system
- Min. 130 MB free hard disk space for installation
- For network operation, or DSL via Ethernet, a 10 / 100 Mbit/s installed network card
- Internet Explorer, version 6.00 and higher

Installation instructions:

The first time you start the Configurator you will be asked to enter your user ID and password. Use »Service« as your user ID and also »Service« as the password. Please note that these words are case-sensitive! Once you've been logged on to the Configurator you can change your user ID and password as you like.

- Start up your PC.
- Insert the CD ROM supplied with the system in the CD ROM drive of your pcs.
- Wait a moment until the program starts automatically. If the autostart option is not activated in your PC you can start the file »setup. exe« directly from the main directory of the CD using Windows Explorer (double click on the file), or using the option »Run« in the Windows start menu.

When the file is started the welcome screen of the CD is displayed.

Configuration with a PC

You can program your pabx over the LAN, USB or via the internal ISDN connection.

- Use the USB connecting cord supplied with the system to connect the USB ports of the PABX and the PC.
Configuration of the PABX through the USB port requires a Windows operating systems that supports USB.
(as of 08/2002: Windows 98 / ME / XP / 2000).
- Use a Cat. 5 Ethernet cable to connect one of the »LAN« Ethernet ports of your pabx with the PC.

or

- Connect your PC with the installed ISDN PC card to the internal ISDN bus using an ISDN connecting cord.

If you have an ISDN card with CAPI 2.0 installed in your PC you can also conduct PC configuration via the internal ISDN connection of the PABX. This type of configuration is possible starting with the Windows 98 / Windows NT4 operating systems.

Professional Configurator

Using this program you can configure the features for your PABX as you require. You can then complete these settings step by step and import them into the PABX. You should also store your configuration on your PC.

Description of the router functions

The PABX system provides all functions required for high-performance Internet access for individual PCs, or for an entire LAN, via xDSL or ISDN. A firewall integrated into the PABX, together with NAT (network address translation) provides the necessary security, while the DHCP server and DNS proxy functions ensure that configuration effort is kept to a minimum, both for the PABX system and for your PCs.

Internet access for all of the PCs connected to the PABX system is provided via one single connection (SUA - single user account); only one set of access data is required from your Internet service providers (ISP). You can configure more than one ISP.

System Requirements for Windows

System requirements:

- IBM or 100% compatible PC.
- Pentium or comparable processor, min. 233 MHz clock rate and MMX-technology.
- One of the following operating systems has to be installed: Windows, 2000, ME, XP or Windows Vista (32 bit).
- RAM for Windows: ME min. 64 MB, 2000, Windows XP (32 bit), min. 128 MB, Windows Vista (32 bit) min. 512 MB.
- You also need a VGA graphics adapter, approx. 65000 colors, a resolution of at least 800x600 pixels.
- The PC has to have a CD ROM drive.
- The required free disk space for installation is 40 MB.
- The PC should have at least one free USB port.
- A network card must be installed to perform configuration via Ethernet.
- To configure your system via the internal ISDN connection, you must have an operational ISDN PC card installed in your PC.
- Internet Explorer Version 6.00 or higher must be installed to use the »WEB- LCR«.

Initial Commissioning and Minimum Configuration

You can connect PC to the PABX system either via Ethernet or USB.

Once you have linked your PC to the PABX system you must select an ISP and, where required, enter you access data. And before you know it you're surfing the Internet.

Connecting the DSL modem to the Ethernet (10BaseT) port

If you have a DSL connection you must connect your DSL modem to the WAN/xDSL port of the PABX system. Use a network cable for this (CAT. 5, 1:1 with RJ-45 connectors at both ends). This cable may be included in the standard delivery scope for your DSL modem.

Note

Please be sure to use a DSL-modem with an Ethernet (10BaseT) port.

Connecting a pcs via USB

At present, only Microsoft Windows operating systems are supported for connection of a PC to the PABX system via the USB port.

Connect your PC to the PABX system using the USB cable supplied with the PABX system. When both devices (PABX and PC) are switched on, the PC will recognize the linked PABX system and installation of a device driver is then started. Then, just follow the instructions shown on the screen.

When you have successfully completed the connection and configuration the LED marked »USB« on the PABX system lights up; when data is being exchanged via the USB port this LED will flicker in the rhythm of data exchange.

The USB driver supplied with the system (RNDIS) is located in the device manager of the Windows control panel as a virtual network adapter. Communication between the PABX system and the PC connected via USB is effected via the TCP-IP protocol.

Note

Please keep the WIN-Tools CD for the PABX system handy when installing the device driver.

Connection of a PC through Ethernet or Fast Ethernet

Regardless of the operating system (Linux, MAC OS, MS-Windows, Palm-OST,...) Or the type of device (PC, MAC, PDA, Webpad) that you are using you can utilize the PABX system Internet access function when the devices are connected via Ethernet or Fast Ethernet. For this purpose the PABX system is provided with the interface LAN. The port designated LAN is set automatically to the maximum data transfer rate (from 100 Mbits/ semi-duplex up to 100 Mbit/s full duplex) for the opposite terminal (PC).

Use a standard Cat. 5 network cable for this connection. If connection has been implemented successfully, the LED marked »LAN« on the PABX lights up; when data is being exchanged via the corresponding port, this LED flickers in the rhythm of data transfer.

For further information about the LED indicator, refer to the section »Display / LEDs« on page 3.

Connecting several PCs via Ethernet

You can connect a PC directly to the LAN ports and another one to the USB port. If you wish to connect more than two PCs you will need a hub or switch.

Spatial constraints may make it more convenient to use a longer network cable e.g. to connect a hub or switch to the LAN-port and connect the pcs to the hub or switch.

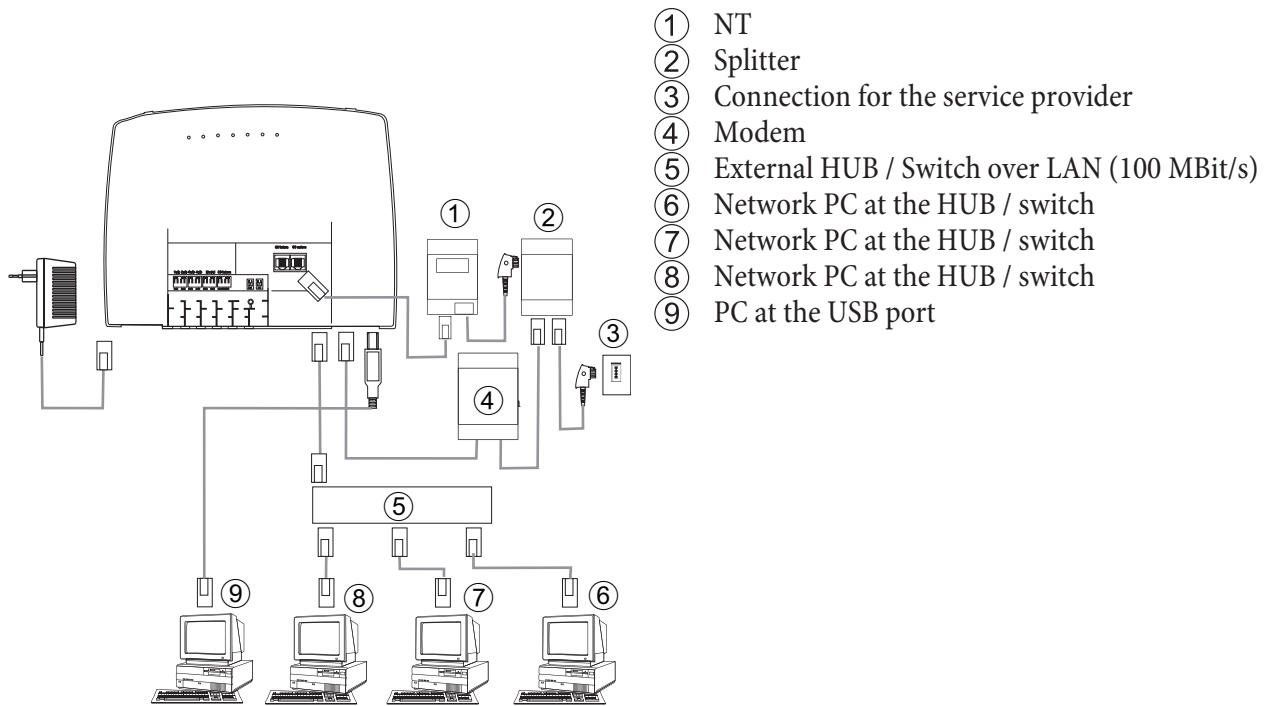

Configuring the PCs

IP addresses

After you connect a PC IP addresses must be assigned. When doing this you must ensure that the IP addresses assigned to the PCs and the PABX systems are in the same IP network. This also applies if you wish to utilize common resources among several PCs in a LAN (for example released directories, network drives, network printers). All PCs located within the network require an IP-address.

In its initial status the PABX is configured with the IP address 192. 168. 1. 250 and the DHCP server integrated into the PABX is activated, meaning that any PCs that are connected must be set to receive their IP address automatically. This mode is recommended to dispense with the complicated, manual configuration of the IP addresses for the pcs that would otherwise be required.

Note

If you are already using a network and wish to use the PABX as the DHCP server you may have to transfer other parameters via DHCP to the pcs.

Only change these parameters if your existing network explicitly demands this. Arbitrarily changed parameters may result in a complete loss of all network functions.

You can configure the following parameters:

Default TTL

If you can not reach certain sites in the Internet (a »ping« is answered with the message »destination unreachable«) it may be meaningful to increase the »TTL« parameter (default is 64) and specify that all PCs configured via DHCP to be re-assigned configuration from the DHCP server (or simply restart your pcs).

MTU

The »MTU« parameter is used for defining the data packet size used in the LAN. Only packets with a maximum »payload« of 1452 bytes can be transported via a DSL Internet portal (when the PPPoE protocol is used, for example with T-Online. Packets in the PABX system should not be first split up and reply packets not re-assembled. It is therefore expedient to use an »MTU« of 1452 bytes to achieve the greatest possible data throughput rate for the DSL connection. This may, however, result in the data transfer rate in the LAN being reduced slightly.

DHCP lease time

The lease time is the time (in seconds) for which a LAN client receives an assigned IP address before that address is fetched and returned to the DHCP server address pool. A LAN client can extend the lease time automatically.

Default gateway

You should enter 0.0.0.0 (place holder for the PABX system IP address) as the »default gateway« if Internet access is to be provided via the PABX system.

Domain Suffixes

You should only configure the parameters »Domain Names« and »DNS server« when you are operating a DNS server within the LAN.

Netbios Name Servers

The »Netbios Nameserver« parameter is used for the name definition for Windows PCs when you use a WINS server in the LAN. This parameter should only be configured when you operate a WINS server in the LAN.

Time Servers

The parameter »Time Servers« is used for announcing the IP address for the »Time lease« when your PCs direct (Windows XP, Linux) the NTP (Network Time Protocol).

DNS Servers

DNS queries from computers in the LAN are normally forwarded to one or more external DNS servers by the DNS proxy. The addresses for the external DNS servers can be obtained dynamically, or can be permanently configured in the router. Addresses can be input at three DNS servers to reduce online time.

DHCP server and IP addressing

PCs can be provided with a major portion of the configuration required for LAN and Internet access via the DHCP (Dynamic Host Configuration Protocol). The DHCP server integrated into the PABX is capable of supplying corresponding configurations to up to 100 PCs (clients). IP addresses are dynamically allocated to the clients. The DHCP server task of the PABX system is activated in the initial status of the PABX.

You can configure the integrated DHCP server under »Network address allocation«.

You can configure the first IP address assigned by the DHCP server. The required number of IP addresses is assigned to the PCs (DHCP clients) in ascending order. There are always 4 additional IP addresses reserved for DHCP servers for PCs integrated into the LAN via Bluetooth (see Page) or RAS (see Page 63). If the integrated DHCP server is activated the 4 IP addresses which come after the configured DHCP address range are used for RAS clients.

When the DHCP servers are de-activated the 4 IP addresses that come after the set DHCP start address will be used for RAS clients.

If you select a configuration in which some computers receive their IP addresses via DHCP, while others use set (manually configured) IP addresses, the following criteria must be fulfilled:

- All IP addresses must belong to the same IP network, meaning that the network part of the IP address (and with it, the netmask) must be identical. Example:
- IP address for the PABX: 192.168.1.250
- IP-netmask of the PABX: 255.255.255.0
- Network part of the IP addresses: 192.168.1.xxx
- First usable IP address: 192.168.1.1
- (netmask: 255.255.255.0)
- Last usable IP address: 192.168.1.254
- (netmask: 255.255.255.0)
- First IP-address via DHCP: 192.168.1.50 (as per configuration)
- Last IP address through DHCP: 192.168.1.69 (as configured)

- Number of IP addresses by DHCP: 20
- IP addresses for RAS per DHCP (4 reserved)
 first IP address: :
 192.168.1.70
 last IP-address: 192.168.1.80
- One IP address may not be used by more than one client at any one time; with regard to the example given above this means that the IP addresses 192.168.1.2 to 192.168.1.49 and 192.168.1.81 to 192.169.1.249 and 192.168.1.251 to 192.169.1.254 can be used for PCs which have manually configured IP addresses.

The configurable parameters for the DHCP server that you can select using the button »Advanced« allow you the option of also using the DHCP server in the existing LAN environment.

Configuration of the Internet Service providers (ISP)

An Internet Service Provider provides you with an »entrance portal« to the Internet. A distinction is made between ISPs with whom you have a contract (for example T-Online) and Internet-by-call providers that bill you through your phone bill (for example Freenet).

The type of access is independent of the tariff charges; this can be based on actual time, volume or be a flat rate.

You can set up a connection to the Internet with your PABX system as follows:

- Dial-up connections via ISDN (using PPP protocol, with one or two ISDN B channels, i. e. at 64 kBit/s or 128 kBit/s).
 These types of connections require access data with the number to be dialed, the user name and password and, in some cases, other information such as the IP address of the name server and any information about the data compression method that is used (VJH).
- Using xDSL (for example ADSL - T-DSL) in conjunction with a DSL modem that is compatible with your ISP via PPPoE.
 These connections require your user name and password as access data.
- Via xDSL (e.g.B: SDSL) in conjunction with a DSL modem that is compatible with your ISP with a set, public IP address. These connections require the public IP address that you have been assigned, the IP address of the next gateway (next hop) and the IP address for the name server of your provider.

Internet-by-Call

The Professional Configurator of the PABX system contains a list of Internet-by-call ISPs from which you can select a provider. The advantage here is that you can set up an Internet connection immediately without first having to agree to a contract. (The requisite access data are already contained in the configuration software for the Internet-by-call ISPs that are listed). You can change this configuration when you decide to conclude a contract with a provider for example (at present required for all DSL providers).

- Fallback configuration for several ISPs »Internet always works«
- You can configure more than one IPS in your PABX system.
- You have one DSL connection that is not always available.
 Here, you can configure the PABX system so that it automatically attempts to set up an Internet connection via DSL. If this attempt is unsuccessful Internet connection via ISDN can be programmed using a different ISP.
- You are using a provider that is not always available (some Internet-by-call providers have very reasonable rates, but their access nodes are overloaded due to heavy traffic during peak times).
 Here you can simply configure several Internet-by-call providers. The PABX system will automa-

tically attempt to set up a connection with one of the configured ISPs.

You can easily change the order of the ISPs with which the Internet connection is to be set up (»Fallback order« down / up). You can also set the number of and intervals between these attempts at setting up an Internet connection for each ISP that has been configured. When the waiting period between the attempts expires and when the configured number of actual attempts is reached and no connection has been established, the next ISP in the list is selected.

Connection to the Internet is always set up automatically by the PABX system when a data packet is to be sent to the Internet. This occurs automatically when you enter `http://www.bintec-elmeg.com` in your browser for example.

Note

Billing of the costs is made through the telephone bill from your network provider.

Discontinuing an Internet connection

- Click on the symbol for the »ControlCenter« in the task bar and select »Terminate connection to provider«.
- After a set time (which can be defined), during which there is no data traffic to the Internet, the connection is terminated automatically. You can activate/de-activate this function in the configuration.

Note

If you set the parameter »Terminate on inactivity« too high, this may result in considerable costs for time-based charges.

Note

If you have a flat rate charge with your ISP you can deactivate the parameter »Terminate on inactivity«. In this case the PABX system will not automatically terminate the Internet connection, but will re-establish the connection if required (for example after being disconnected by the ISP). If you have configured several ISPs, make sure that you make this setting for the correct ISP entry in the ISP list!

Using a fallback

Let's assume you have a DSL connection with the Deutsche Telekom AG (German Telecom) and have selected T-Online as your ISP.

You have configured three ISPs:

1. Internet access through T-DSL (T-online). The PABX system will use the PPPoE protocol at the WAN port. Enter your access data (mark the ISP in the list, field »Edit«, field »Access data for T-Online«)
2. Internet access via ISDN (T-Online). The PABX system will use an ISDN dial-up connection (and the PPP protocol). Enter the same access data (mark the ISP in the list, field »Edit«, field »Access data for T-Online«).
3. Internet access using an Internet-by-call provider. The PABX system will use an ISDN dial-up connection (and the PPP protocol). When you select an Internet-by-call provider from the defined list, the corresponding parameters are already configured (»Access data«, »Number«).

If there is a disturbance with the DSL connection, the PABX system will, after a configured time period keep attempting to set up the Internet connection for the number of times configured in the field »Number of connection attempts«. You can activate/de-activate this function in the configuration. You can set the intervals between the at-

tempts using the parameter »Time between attempts« in the configuration item Network Internet. You can set the number of attempts and the interval between these attempts separately for each ISP that has been configured.

After that, the PABX system will use the next ISP configured in the list for attempting to set up a connection.

If the connection is disrupted and an attempt is to be made later to re-establish the connection, this cycle is restarted beginning with the first entry in the list.

Firewall

When you use NAT, the PCs connected to the PABX are well protected against attacks from the Internet.

If you wish to have additional security you can also use the integrated package Filter Firewall. A firewall acts as a logical wall for data packets between the Internet and the LAN which has »holes« for certain packets (firewall rules, also known as filters), allowing these packets to pass through the wall. In the initial status the firewall is configured such that all data can pass through that are sent in the direction of the Internet.

Note

An exception to this rule is the »Netbios filter: This filter prevents the forwarding of Netbios name queries from Windows PCs to the Internet. As the names of the Windows PCs within the LAN are not known in the Internet, it is not meaningful to establish an Internet connection for forwarding the name query (this could result in considerable costs, as these name queries occur frequently, meaning that the Internet connection would practically never be terminated).

The filters are described by rules whose configuration requires expert knowledge about the TCP/IP protocol family. The firewall of your PABX system can be easily configured using a Filter Wizard in which you need to indicate (in plain text) whether you wish to allow defined applications access to the Internet.

To start the Filter Wizard in the configuration item »Network filters« click the button »Filter Wizard«. The following mask is then displayed after a warning that starting the Filter Wizard will delete all filters that have been configured up to this time:

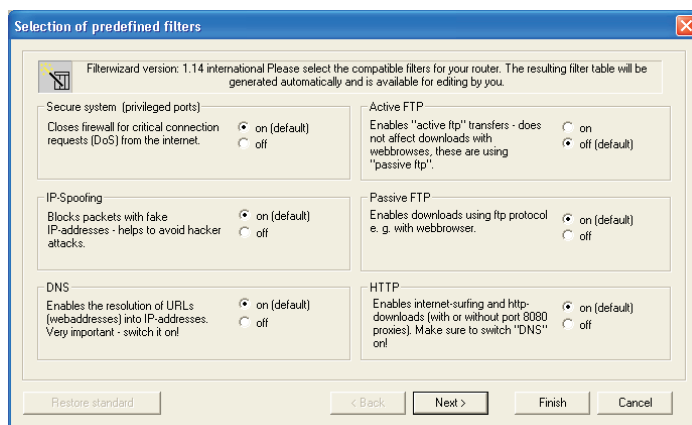

The Filter Wizard can be restarted at any time to load a modified (edited) configuration into the PABX system. Click the button »Send configuration data« to transfer and activate the filters. After the data is sent the new configuration is activated in the PABX system and any ongoing Internet connection is terminated.

The connection is re-established however as soon as a data packet must be routed to the Internet which the firewall lets pass in accordance with its configuration.

Notes:

Note that when you click the button Send, the entire configuration for the PABX system will be overwritten. It is strongly recommended to read out the configuration for the PABX system and storing it in a file prior to changing the filter configuration.

We recommend following the instructions given by the Filter Wizard, unless you establish that one of the applications you are using can not set up a connection to the Internet. In this case, please check whether the Filter Wizard has a corresponding filter available. Elmeg regularly generates an updated database for the Filter Wizard, which is available at the www.bintec-elmeg.com Web site.

Please note that all filters that are generated with the Filter Wizard are based on packets being discarded, with the exception of those for which an appropriate rule exists. The more filters you configure for the PABX system, the more computing time is required for processing of these filters. This could slightly reduce the maximum achievable data throughput rate for the PABX system in some cases.

Information on manual configuration of firewall filter rules is given in the online Help function and in the documentation located on the CD.

Costs for Internet connections

The PABX can store up to 500 call data records. This data is not lost in the event of a loss of power.

The PABX system also generates a call date record for connections made by the router. The call data records contain detailed information about the call. For ex.: Date and time, duration of the call, number of the called party, number of the calling party, type of connection, communication costs and possible project numbers.

Note

Please note that only the network service provider is authorized for binding connection/call cost logging. You should use a virus scanner on all LAN clients to protect your personal data. Use of this type of software is indispensable for safeguarding personal data.

Dial-in into the LAN (RAS)

Using the Remote Access Server (RAS) a field representative, for example, can call into the local network from an external location and then via the local network access the Internet. Access from an external location is also possible via an ISDN connection.

External access is provided with user-name and password protection. If the call is made from an external location only, the phone number can also be monitored as an added protection feature. Access can be enabled for up to 8 users. A Windows enable (access to computer, files or printers) and Internet enable can also be configured for each user.

Note

Note that this access portal is not protected by a firewall!

A PC that dials into the local network via RAS is automatically assigned an IP address by the integrated DHCP server.

Appendix

Troubleshooting

Not every fault or malfunction is an actual PABX system error. Check your installation configuration with the aid of the following section.

Fault Description	Possible Cause	Fault Remedy
No dial tone after lifting handset.	PABX not connected to power supply properly.	Check 230 V AC outlet (for example by plugging in a lamp)
	Plug-in power supply unit / power plug not plugged in properly	Check connection between PABX and 230 V AC outlet.
	Terminal device defective.	Replace terminal device / Check terminal device at other connection
	Telephone connection faulted, Faulty installation	Check PABX / jack connections
	PABX settings faulted, ambiguous programming of PABX system	Unplug and plug the plug-in power supply unit back in. Reset the PABX to initial state.
No internal calls are received.	Station guarding (do not disturb) is active.	Deactivate station guarding (do not disturb).
	Call forwarding to another number activated (special dial tone in handset).	Cancel call forwarding.
No external calls are received.	Same causes and remedies possible as for »No incoming internal calls«.	
	PABX not connected correctly to the network termination unit of your network service provider.	Check the connection between the PABX and network termination unit.
	MSN is not entered or assigned correctly in the PABX.	Check the PC configuration for the PABX.
Note: Check to ensure that ISDN connection is functioning correctly, and that this connection has been enabled by your network service provider. Please contact your service provider.		
No outgoing, external calls possible.	No authorization for external connections.	Check the user settings in the PC configuration for the PABX.
No outgoing, external calls possible.	Call charge limit reached (Allowance account).	Check the user settings in the PC configuration for the PABX. Increase cost limit, or reset the sum counter
	External numbers classified as restricted numbers for call control.	Check the settings for dial ranges in the PC configuration for the PABX
No external connections possible to some remote terminals.	External numbers are given in the Restricted numbers list for the dialing region.	Check the settings for dial ranges in the PC configuration for the PABX

Room inquiry not possible during an external call.	The telephone's flash key is not properly configured.	Check the setting of your telephone's flash key. »Flash key«, flash interval 80-120 ms. or modify the configuration settings in »Internal subscriber«. Attention: Inquiry calls are not possible with pulse dialing telephones.
If the PABX is connected at the USB port of the PC and recognized by the PC the USB LED on the PABX will light up. If not, the USB ports of the pc are not activated / faulty, or the drivers for the PABX are not installed.		
	The same causes and remedies are possible as described for the previous problems (no internal/external connections possible).	
No connections can be established via the PABX's USB-port.	The USB ports of the pcs are not activated or are defective.	In the system control panel (folder »System« - »Device manager«) check whether the USB ports of your pc have been activated.
	PABX drivers not properly loaded.	In the system control panel (folder »System« - »Device manager«) check whether the PABX has been installed correctly. A question mark in front of the entry for the PABX indicates incorrectly installed / loaded drivers. Plug the USB connector for the PABX system back into the PC or restart your PC.
No automatic call-backs possible.	No pabx number has been entered with a point-to-point access.	While configuring your pabx system with the PC, make this entry under External Numbers.
No call rerouting possible. for example to T-Net-Box.		
Invoicing for your Charge Manager is set too high or too low by one fixed factor.	Transfer of the currency amount is set for your ISDN connection instead of transfer of tariff data.	Apply for the procedure you wish to have, or change the rate factor in the Charge Manager and in the Professional Configurator.

Technical specifications

PABX:

dimensions W x H x D:	295 x 305 x 60 mm
Weight, approximately:	1.6 kg
Temperature range:	5° C...40° C
Mains voltage:	230 V~
Rated power consumption with 2 connected ISDN phones:	approx. 8 VA
Maximum power consumption:	25 VA
Frequency:	50 Hz
Protection class:	II
Connection cord length:	approx. 2 meters

ISDN connections:

Length of ISDN connection cord:	approx. 3 meters
External ISDN connection:	Protocol DSS1, Point-to-multipoint connection Protocol DSS1, Point-to-point connection
Internal ISDN connection:	DSS1 protocol, point-to-multipoint connection
ISDN interfaces:	Power appr. 2.5 W
Channel structure:	B+B+D
ISDN cable lengths with 0.6 mm Wire diameter:	Short passive bus: max. length of 120 meters

Analog ports:

Supply (PABX):	symmetrical, 25 mA at 600 ohms
Max. length of telephone connection cables when using installation-grade cable:	0.4 mm wire diameter = 1 km 0.6 mm wire diameter = 2 km
Dialing method:	Multi-frequency calling method Pulse dialing (limited function)
Mark duration:	> 40 ms and <100 ms
Space duration:	80 ms
Ringing voltage:	U eff. appr. 35 V~
Ringing frequency:	50 Hz ± 8%
Adjustable flash interval:	100ms to 1000ms in 100ms steps (default state 200ms)

USB port:

USB cord length:	approx. 3 meters
------------------	------------------

Terminal:	Self powered terminal
Speed rating:	Full Speed
Ethernet connections:	
LAN	10/100MBit/s via RJ45 jack
WAN/xDSL	10MBit/s via RJ45 jack

Brief description of functions

This brief description of functions applies to the use of analog terminals. If certain functions of ISDN terminals are not possible, please do refer to the operating instructions of the respective ISDN terminal.

Pick-up of the call

* 0 Pick-up of the call

Making internal calls

Making internal calls
 * Internal calls with automatic line acquisition

Making outside calls

0 Making outside calls
 Outside calls with automatic line acquisition

8 1 0 ... 9 Sending MSN to remote parties
 0 ... 9 4MSN-Index

* 8 Specific trunk bundle selection (ISDN, POTS (0...4))

* 8 # Specific trunk bundle selection .ISDN /, POTS, SIP-prov. (00...04), (10...19)

* 5 * (PIN) Telephone interlock (cancel)

Temporarily suppressing transmission of your own number (CLIR)

* 5 9 4 Temporarily suppressing transmission of your own number (CLIR)

Dialing phone numbers from the phone directory

* # Dialing a phone number via the speed dialing key of the PABX's phone directory

Forwarding a call (connecting)

R Forwarding an internal call with prior notice

R Forwarding an internal call without prior notice

R Inquiry call

R Terminating a room inquiry with analog terminals

R 4 Connecting external callers

Broker`s call

R Broker`s call (room inquiry)

R 2 Broker`s calls between different callers

Completion of call

* 4 0 Requesting automatic call-back

4 0 Canceling automatic call-back

Three-party conference call

R Inquiry call

R 3 * Three-party conference call

* R 2 Returning to Broker`s call

Call waiting

R 2

Accepting a waiting call. The call put on hold remains

Accepting a waiting call. The call put on hold is terminated

R 0

Refusing a waiting call

Announcement

*** 5 4 0**

Message to a party

Call modes

*** 9 * ***

Activating all day call modes

9 * *

Activating all night call modes

Call modes for teams

*** 9 4 3 0 0 ... 1 9**

Enabling a member's phone within a team

9 4 3 0 0 ... 1 9

Inhibiting a member's phone within a team

*** 9 3 * ***

Activating day team call assignment for all teams

9 3 * *

Activating night team call assignment for all teams

Call forwarding

*** 6 1**

Activating »immediate« call forwarding

*** 6 2**

Activating call forwarding »delayed«

*** 6 3**

Activating call forwarding »on busy«

6 1

Canceling »immediate« call forwarding

6 2

Canceling »delayed« call forwarding

6 3

Canceling call forwarding »on busy«

Follow me

*** 6 4**

Configuring internal Follow me

6 4

Canceling internal Follow me

Room monitoring

*** 5 9 3**

Enabling room monitoring

Room monitoring from internal terminals

Inhibiting calls

*** 5 7 0**

Inhibiting internal and outside calls

*** 5 7 1**

Inhibiting outside calls

*** 5 7 2**

Inhibiting internal calls

5 7 0

Re-enabling all calls

Malicious call identification (MCID)

*** 5 1**

Malicious call identification (MCID)

Project numbers

*** 5 0**

Entering a project number

R * 5 0

Project number for an external call

R

Answering machine:

↑ # 0 ↓

Pick-up of a call from the answering machine

Multifunctional device

↑ * 7 7 3 ☎ ↓

Multifunctional device: Telefax group 3

Keypad functions

↑ 0 (* or #) t

Initiating keypad functions

For a description of the features please refer to then network operator's documentation.

System parked inquiry

↓ R * 5 9 6 ☎ ↓

Initiating a system-parked inquiry

↑ * 5 9 6 ↓

Accepting a system-parked inquiry

Quick Reference for Voicebox

Listen to new message	1	
The new messages are then played back one after the other, with each one being separated by the positive acknowledgement signal.		
Listening to the next message (You finish listening to one message and then listen to the next one).	1	
Repeat the current message (The message that you are currently listening to will be repeated).	2	
Delete the current message (The message that you are currently listening to will be deleted).	3	
Listening to old messages or recorded calls.	2	
Older messages are played back one after the other, each one separated by a positive acknowledgement signal.		
Listen to next message.	1	
Repeat the current message.	2	
Deleting of the last message that was listened to.	3	
Delete all saved messages and recorded calls	3	
New messages and messages that have already been listened to. You hear the positive acknowledgement signal. Press the asterisk key; all messages that have been listened to previously will be deleted.		 *
Activating/De-activating the Voicebox	4	
Activating the Voicebox in the current call mode.		0 *
Da-activating the Voicebox.		0 0
Activating the Voicebox in the »Day« mode.		0 1
Activating the Voicebox in the »Night« mode.		0 2
Configuring the Voicebox in the »Day« mode.	4	
Da-activating the Voicebox.		1 0
Activate the Voicebox, calls taken immediately.		1 1
Activate the Voicebox, calls taken after set time (delayed).		1 2
Activate voicebox on busy		1 3
Activate voicebox on busy and after time		1 4
Activate the Voicebox as an answering machine. Recording an announcement text and a message.		1 5
Activate the Voicebox for only one announcement. Announcement only, no message.		1 7
Configure the voicebox for »Night« mode	4	
Deactivate Voicebox.		2 0

Activate the Voicebox, calls taken immediately.		2 1
Activate the Voicebox, calls taken after set time (delayed).		2 2
Activate voicebox on busy		2 3
Activate voicebox on busy and after time		2 4
Activate the Voicebox as an answering machine. Record announcement text and message		2 5
Activate the Voicebox for only one announcement. Announcement text only, no message.		2 7
Listening to or recording announcements	5	
Listening to recorded announcement text.		1
Recording an announcement. To end recording dial »0«. Dial »50« to accept the announcement text.		2 ☒ 0 5 0
Listening to recorded announcement text.		4
Recording an information text. Dial »0« to end recording. Dial »50« to accept the announcement text.		5 ☒ 0 5 0
Accepting the announcement text.	5	
Accept.		0
Security settings	9	
Changing the Voicebox PIN.. Enter the new PIN two times.		1 ☒ * ☒
Return to main menu.	#	

Index

A

Accepting

of calls 11

Accepting a waiting call 17

Activating the LCR procedure 23

Adobe Acrobat Reader 52

ADSL 60

Alarm call 24

Alarm call list 24

Allocating project numbers 15

Analog terminal devices 1

Announcement 14

Answering machine 11,28

Appointment call 23

Area code 44

Automatic completion of call

canceling. 12

at no answer 12

configuring. 12

on busy 12

B

Background music 6

Block dialing. 22

Brief description of functions 69-72

Broker's call 19

Button function 25

C

Call

accepting 11

Call data 51

Call data records 63

Call modes 20

Call modes for teams 20

Call rerouting 20

Call switching in the network (ECT) 18

Call waiting 17

CAPI driver

Installation (Important note) 53

CAPI in LAN. 52

CD-ROM

contents 51

Installation sequence 54

CE marks B

Charge counter 26

Charge limit 26

Charge limitation 26

Charge Manager. 51

Cleaning. 2

CLIP 3

code numbers, modified 26

Commissioning an IP-phone. 49-50

Commissioning of the PABX 44

Communication cost display. 26

Communication costs 26

Communication data 26

Completion of call (automatic)

canceling. 12

activating. 12

at no answer 12

delete 13

on busy 12

Configuration 46

Conference. 19

Configuration 46-48

Configuration with a PC 54-55

Configuring performance features using a telephone
46-48

Configuring wake-up call from »Reception desk pho-
ne« 23

Configuring wake-up calls from the room phone23

Connection data. 51

- Connection of the DSL Modem 56
- ControlCenter 51
- Costs for Internet connections. 63
- Coupled calls 6

- D**
- Declaration of conformity. B
- Default gateway 59
- Default setting. 43
- Description 1
- Description of the router functions 56
- DHCP lease time 59
- DHCP Servers 59
- Dialer protection 6
- Dial-in into the LAN 63
- Dialing method 1,66
- Direct exchange line access 10
- Discontinuing an Internet connection 61
- Display. 4
- DNS Server. 59
- Domain Suffixes. 59
- Door intercom device. 23
- Door opener 24
- Download Manager 51
- Drivers on the CD ROM 52-53
- DSP module 49-50

- E**
- ECT (explicit call switching). 18
- Enable / inhibit call waiting for a further call . 17
- Ethernet 57
- External Follow me, set up / delete 22

- F**
- Fallback 61
- Fast Ethernet. 57
- Features 6-9
- Features in the ISDN network. 3

- Firewalls 62
- Flash 10
- Flash key. 1
- Follow me 21

- G**
- Gateway 59-60

- H**
- Handling. 1

- I**
- Inhibiting calls. 20
- Initial startup 44
- Installation
 - of programs from CD 54
 - of the CAPI driver 53
- Intercom 27
- Internet Service Provider. 60
- Internet-by-Call 60
- IP addresses 58
- IP addressing 59
- IP-netmask. 59
- ISP 60

- K**
- Keypad (Net fixed) 16

- L**
- Language 27
- LEDs of the PABX 4
- Loss of power. 2-5

- M**
- Making Calls
 - External. 10
 - Internal. 11
- Making outside calls with direct exchange line access 10
- Making telephone calls 10

- Malicious call identification (Tracing) 15
- Melody 44
- MFV 1
- Microdrive 31
- Modified code numbers 26
- MTU 58
- Multifunctional device 16

- N**
- Net fixed (keypad) 16
- Netbios filter. 62
- Netbios name queries. 62
- Netbios Name Server 59
- Number of Voiceboxes 30

- O**
- Output of call data records. 26
- Own number
 - defining for the next call 13

- P**
- PABX and PC 51
- Pabx dimensions 66
- Parliament B
- Partial Rerouting.. 3
- PC programs on the CD-ROM. 51
 - Adobe Acrobat Reader 52
- PC requirements. 54,56
- PC Requirements 54,56
- Phone number plan. 43
- Pick up 11
- Picking up calls for a specific subscriber 11
- Pick-up
 - calls from answering machine 11
- PIN 1
 - Security precaution against misuse of your PABX by other parties 47
- PIN 2
 - security for settings made from external telephones 47
- Pocket money account 26
- Point-to-multipoint connection. 66
- Point-to-point connection 66
- Professional Configurator 51
- Pulse dialing. 1
- Pulse dialing 66
- Pulse dialing method 66

- Q**
- Quick reference - Voicebox 73-74

- R**
- RAS 63
- Reception desk phone 23
- Recording time per Voicebox 30
- Remote access 51
- Reserve trunk group 13
- Reserving an external ISDN port 13
- Room inquiry. 16
- Room inquiry with waiting caller 17
- Room monitoring. 14
- Room telephone. 23

- S**
- safety notes 1
- Service access 46
- Service number 43
- Service-Connection, incoming. 46
- Service-Connection, outgoing 46
- Setting up call forwarding from an external location 22
- Signaling features 24
- Silent signalling 20,26
- Speaking alternatively with two parties. 19
- Speaking simultaneously with two parties 19
- Speed dialing from the telephone directory . . 13
- Storage capacity 30

- Symbols 2-5
- system menu. 26-27
- System parked inquiry 17
- System Requirements. 56
- System telephones 27
- T**
- TAPI driver 53
- TAPI in the LAN 52
- TAPI-Configuration 52
- T-DSL. 60-61
- Teams 21
- technical specifications 66-67
- Telephone directory 13
- Telephone Directory Manager. 51
- Telephone interlock. 12
- Temperature range 66
- Temporarily suppressing transmission of your own number. 13
- Terminating an Internet connection from the phone
25
- Three-party conference. 19
- Tracing (Malicious call identification) 15
- Transfer a call 18
- Transferring a call. 18
- Troubleshooting. 64-67
- Trunk group seizure 11
- TTL 58
- U**
- Unrestricted data 6
- USB driver 52
- Using system telephones 27
- Using the Voicebox at a phone 32
- V**
- Voice announcement 13
- Voice announcement with background music 6
- Voicebox 28
- Voicebox - PIN 39
- W**
- Waiting call
- accepting 17
- Wake-up call. 23
- Weight 66
- Windows 95 / NT4 54
- Windows configurator 51

